



IBM USB 2.0 CD-RW/DVD-ROM Combo Drive

User's Guide



IBM USB 2.0 CD-RW/DVD-ROM Combo Drive

User's Guide

Note

Before using this information and the product it supports, read Appendix B, "Service and Support," Appendix C, "IBM Statement of Limited Warranty - Z125-4753-07 - 11/2002," and Appendix D, "Notices."

First Edition (March 2004)

© Copyright International Business Machines Corporation 2004. All rights reserved.

US Government Users Restricted Rights – Use, duplication or disclosure restricted by GSA ADP Schedule Contract with IBM Corp.

Contents

Safety	v	Playing back the audio CD	5-3
		Windows 2000	5-3
		Windows XP.	5-5
General safety guidelines.	vii	Chapter 6. Application software.	6-1
Service	vii	Chapter 7. Using the Combo Drive . . .	7-1
Power cords and power adapters	vii	Before you begin	7-1
Extension cords and related devices	viii	Handling and caring for a disc.	7-1
Plugs and outlets	viii	Caring for the Combo Drive	7-2
Batteries	viii	Cleaning the drive.	7-2
Heat and product ventilation	ix	Using the drive.	7-2
CD and DVD drive safety.	ix	Using single and double-sided DVD-RAM	
		media	7-2
About this book	xi	Precautions for handling.	7-2
Registering your option	xi	Using the drive with CDs and DVDs	7-3
Chapter 1. Combo Drive quick install	1-1	Using the DVD player software	7-3
Product description	1-1	Using the DVD function	7-3
Hardware and software requirements	1-2	Enabling driver letter access (DLA)	7-3
Power mode configurations.	1-2	Installing WinDVD and viewing a DVD movie	7-4
Configuration 1: self power (AC adapter)		DVD region codes	7-4
configuration	1-3	Starting WinDVD	7-5
Configuration 2: auxiliary USB power		Using the CD-R and CD-RW function	7-5
configuration	1-4	Using the DVD+R, DVD+RW, DVD-R, DVD-RW,	
Configuration 3: standard USB bus power		and DVD-RAM function (read only)	7-5
configuration	1-5	Backing up a CD	7-6
Requirements	1-5	Problem solving	7-6
Specifications	1-5		
Chapter 2. Cabling the Combo Drive to		Appendix A. Product specifications	A-1
the ThinkPad computer	2-1	Appendix B. Service and Support.	B-1
Chapter 3. Features	3-1	Online technical support.	B-1
Chapter 4. Preparing to use the		Telephone technical support	B-1
Combo Drive.	4-1	Appendix C. IBM Statement of Limited	
Chapter 5. Combo Drive hardware		Warranty - Z125-4753-07 - 11/2002	C-1
installation and removal in Windows		Part 2 - Country-unique Terms	C-4
2000 and Windows XP.	5-1	Part 3 - Warranty Information	C-15
Removing the Combo Drive hardware	5-1	Appendix D. Notices	D-1
Windows 2000	5-1	Trademarks	D-2
Windows XP.	5-2	Electronic emission notices	D-2
Setting the media	5-2	Federal Communications Commission (FCC)	
Ejecting the media	5-2	statement	D-2

Safety

Before installing this product, read the Safety Information.

مج، يجب قراءة دات السلامة

Antes de instalar este produto, leia as Informações de Segurança.

在安装本产品之前，请仔细阅读 **Safety Information** (安全信息)。

Prije instalacije ovog produkta obavezno pročitajte Sigurnosne Upute.

Před instalací tohoto produktu si přečtěte příručku bezpečnostních instrukcí.

Læs sikkerhedsforskrifterne, før du installerer dette produkt.

Ennen kuin asennat tämän tuotteen, lue turvaohjeet kohdasta Safety Information.

Avant d'installer ce produit, lisez les consignes de sécurité.

Vor der Installation dieses Produkts die Sicherheitshinweise lesen.

Πριν εγκαταστήσετε το προϊόν αυτό, διαβάστε τις πληροφορίες ασφάλειας (safety information).

לפני שתתקינו מוצר זה, קראו את הוראות הבטיחות.

A termék telepítése előtt olvassa el a Biztonsági előírásokat!

Prima di installare questo prodotto, leggere le Informazioni sulla Sicurezza.

製品の設置の前に、安全情報をお読みください。

본 제품을 설치하기 전에 안전 정보를 읽으십시오.

Пред да се инсталира овој продукт, прочитајте информацијата за безбедност.

Lees voordat u dit product installeert eerst de veiligheidsvoorschriften.

Les sikkerhetsinformasjonen (Safety Information) før du installerer dette produktet.

Przed zainstalowaniem tego produktu, należy zapoznać się z książką "Informacje dotyczące bezpieczeństwa" (Safety Information).

Antes de instalar este produto, leia as Informações sobre Segurança.

Перед установкой продукта прочтите инструкции по технике безопасности.

Pred inštaláciou tohto zariadenia si prečítajte Bezpečnostné predpisy.

Pred namestitvijo tega proizvoda preberite Varnostne informacije.

Antes de instalar este producto lea la información de seguridad.

Läs säkerhetsinformationen innan du installerar den här produkten.

安裝本產品之前，請先閱讀「安全資訊」。

General safety guidelines

Always observe the following precautions to reduce the risk of injury and property damage.

Service

Do not attempt to service a product yourself unless instructed to do so by the IBM Support Center. Use only an IBM authorized service provider who is approved to repair your particular product.

Note: Some parts can be upgraded or replaced by the customer. These parts are referred to as Customer Replaceable Units, or CRUs. IBM expressly identifies CRUs as such, and provides documentation with instructions when it is appropriate for customers to replace those parts. You must closely follow all instructions when performing such replacements. Always make sure that the power is turned off and that the product is unplugged from any power source before you attempt the replacement. If you have any questions or concerns, contact the IBM Support Center.

Power cords and power adapters

Use only the power cords and power adapters supplied by the product manufacturer.

Never wrap a power cord around the power adapter or other object. Doing so can stress the cord in ways that can cause the cord to fray, crack or crimp. This can present a safety hazard.

Always route power cords so that they will not be walked on, tripped over, or pinched by objects.

Protect the cord and power adapters from liquids. For instance, do not leave your cord or power adapter near sinks, tubs, toilets, or on floors that are cleaned with liquid cleansers. Liquids can cause a short circuit, particularly if the cord or power adapter has been stressed by misuse. Liquids can also cause gradual corrosion of the power cord terminals and/or the connector terminals on the adapter which can eventually result in overheating.

Always connect power cords and signal cables in the correct order and ensure that all power cord connectors are securely and completely plugged into receptacles.

Do not use any power adapter that shows corrosion at the ac input pins and/or shows signs of overheating (such as deformed plastic) at the ac input or anywhere on the power adapter.

Do not use any power cords where the electrical contacts on either end show signs of corrosion or overheating or where the power cord appears to have been damaged in any way.

Extension cords and related devices

Ensure that extension cords, surge protectors, uninterruptible power supplies, and power strips that you use are rated to handle the electrical requirements of the product. Never overload these devices. If power strips are used, the load should not exceed the power strip input rating. Consult an electrician for more information if you have questions about power loads, power requirements, and input ratings.

Plugs and outlets

If a receptacle (power outlet) that you intend to use with your computer equipment appears to be damaged or corroded, do not use the outlet until it is replaced by a qualified electrician.

Do not bend or modify the plug. If the plug is damaged, contact the manufacturer to obtain a replacement.

Some products are equipped with a three-pronged plug. This plug fits only into a grounded electrical outlet. This is a safety feature. Do not defeat this safety feature by trying to insert it into a non-grounded outlet. If you cannot insert the plug into the outlet, contact an electrician for an approved outlet adapter or to replace the outlet with one that enables this safety feature. Never overload an electrical outlet. The overall system load should not exceed 80 percent of the branch circuit rating. Consult an electrician for more information if you have questions about power loads and branch circuit ratings.

Be sure that the power outlet you are using is properly wired, easily accessible, and located close to the equipment. Do not fully extend power cords in a way that will stress the cords.

Connect and disconnect the equipment from the electrical outlet carefully

Batteries

All IBM personal computers contain a non-rechargeable coin cell battery to provide power to the system clock. In addition many mobile products such as Thinkpad notebook PCs utilize a rechargeable battery pack to provide system power when in portable mode. Batteries supplied by IBM for use with your product have been tested for compatibility and should only be replaced with IBM approved parts.

Never attempt to open or service any battery. Do not crush, puncture, or incinerate batteries or short circuit the metal contacts. Do not expose the battery to water or other liquids. Only recharge the battery pack strictly according to instructions included in the product documentation.

Battery abuse or mishandling can cause the battery to overheat, which can cause gasses or flame to “vent” from the battery pack or coin cell. If your battery is damaged, or if you notice any discharge from your battery or the buildup of foreign materials on the battery leads, stop using the battery and obtain a replacement from the battery manufacturer.

Batteries can degrade when they are left unused for long periods of time. For some rechargeable batteries (particularly Lithium Ion batteries), leaving a battery unused in a discharged state could increase the risk of a battery short circuit, which could

shorten the life of the battery and can also pose a safety hazard. Do not let rechargeable Lithium-Ion batteries completely discharge or store these batteries in a discharged state.

Heat and product ventilation

Computers generate heat when turned on and when batteries are charging. Notebook PCs can generate a significant amount of heat due to their compact size. Always follow these basic precautions:

- Do not leave the base of your computer in contact with your lap or any part of your body for an extended period when the computer is functioning or when the battery is charging. Your computer produces some heat during normal operation. Extended contact with the body could cause discomfort or, potentially, a skin burn.
- Do not operate your computer or charge the battery near flammable materials or in explosive environments.
- Ventilation slots, fans and/or heat sinks are provided with the product for safety, comfort, and reliable operation. These features might inadvertently become blocked by placing the product on a bed, sofa, carpet, or other flexible surface. Never block, cover or disable these features.

CD and DVD drive safety

CD and DVD drives spin discs at a high speed. If a CD or DVD is cracked or otherwise physically damaged, it is possible for the disc to break apart or even shatter when the CD drive is in use. To protect against possible injury due to this situation, and to reduce the risk of damage to your machine, do the following:

- Always store CD/DVD discs in their original packaging
- Always store CD/DVD discs out of direct sunlight and away from direct heat sources
- Remove CD/DVD discs from the computer when not in use
- Do not bend or flex CD/DVD discs, or force them into the computer or their packaging
- Check CD/DVD discs for cracks before each use. Do not use cracked or damaged discs

About this book

This manual contains instructions for installing the IBM® USB 2.0 CD-RW/DVD-ROM Combo Drive hardware for the three power mode configurations that the Combo Drive supports.

This manual provides installation instructions in the following languages:

- Brazilian Portuguese
- Czech
- English
- French
- German
- Italian
- Japanese
- Simplified Chinese
- Slovak
- Spanish
- Traditional Chinese
- Turkish

Registering your option

Thank you for purchasing this IBM product. Please take a few moments to register your product and provide us with information that will help IBM to better serve you in the future. Your feedback is valuable to us in developing products and services that are important to you, as well as in developing better ways to communicate with you. Register your option on the IBM Web site at:

<http://www.ibm.com/pc/register/>

IBM will send you information and updates on your registered product unless you indicate on the Web site questionnaire that you do not want to receive further information.

Chapter 1. Combo Drive quick install

This chapter contains instructions for installing the IBM USB 2.0 CD-RW/DVD-ROM Combo Drive.

Product description

The IBM USB 2.0 CD-RW/DVD-ROM Combo Drive is a slimline DVD-ROM and CD recordable drive that attaches quickly and conveniently to your IBM ThinkPad® computer through a simple connection. The drive is a USB 2.0 device and requires connection to a USB 2.0 port. A maximum write speed of 24x (CD-R/CD-RW media) can be obtained. Maximum read speeds of 8x (DVD media) and 24x (CD media) can be obtained.

In addition to this manual, the option package includes:

- IBM USB 2.0 CD-RW/DVD-ROM Combo Drive



- Standard USB cable and power cable assembly (used for configuration 1 on page 1-3 and configuration 3 on page 1-5); IBM Part Number 22P9216

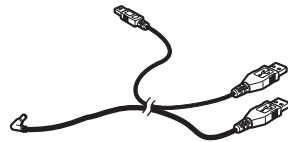

- IBM powered USB 2.0 cable assembly (used for configuration 2 on page 1-4); IBM Part Number 22P9217



- Power adapter

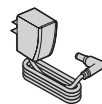

- *IBM USB 2.0 CD-RW/DVD-ROM Combo Drive Software and Guide Super CD*



- Safety information manuals (two)



- Carrying case

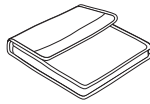

Contact your place of purchase if an item is missing or damaged. Be sure to retain your proof of purchase and packing material. They might be required to receive warranty service.

Hardware and software requirements

You must have the following hardware installed on your ThinkPad computer in order to use this option:

- An available USB 2.0 port

Note: An additional USB 2.0 port may be necessary for configuration 3 on page 1-5.

Your computer must have one of the following operating systems installed to use this option:

- Microsoft® Windows® XP
- Microsoft Windows 2000 Professional (Service Pack 4 or later)

Note: The drive will not operate correctly unless Service Pack 4 or later is installed.

Power mode configurations

This section provides installation instructions for the following configurations:

- Configuration 1: self power (AC adapter)
- Configuration 2: auxiliary USB power
- Configuration 3: USB standard bus power

Configuration 1: self power (AC adapter) configuration

The Combo Drive is usually used with the self power (AC adapter) configuration.

Requirements

- Standard USB cable and power cable assembly (shipped with this option); IBM Part Number 22P9216
- AC adapter (shipped with this option)

Specifications

Read and write CD media and DVD read only media are supported.

Connecting the Combo Drive using configuration 1

To connect the Combo Drive to your system, complete the following procedure. Refer to Figure 1-1 during installation.

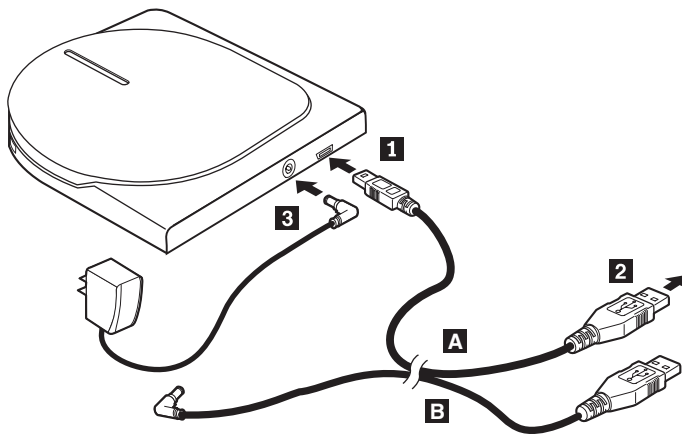

Figure 1-1. Configuration 1: self power (AC adapter) configuration

1. Turn on your computer.
2. Using the USB cable **A**, insert the cable plug **1** into the USB connector of the drive.
3. Plug the standard USB connector **2** into the USB port of your computer.
4. Connect the AC adapter to the DC IN connector **3** on the Combo Drive.

Note: USB cable **B** is not required for this configuration.

Configuration 2: auxiliary USB power configuration

The auxiliary USB bus power configuration can be used on select IBM ThinkPad computers equipped with the IBM powered USB 2.0 port.

Requirements

- IBM powered USB 2.0 cable assembly (shipped with this option); IBM Part Number 22P9217
- IBM powered USB 2.0 port

Specifications

Read/write CD media and read only DVD media are supported.

Connecting the Combo Drive using configuration 2

To connect the Combo Drive to your system, complete the following procedure. Refer to Figure 1-2 during installation.

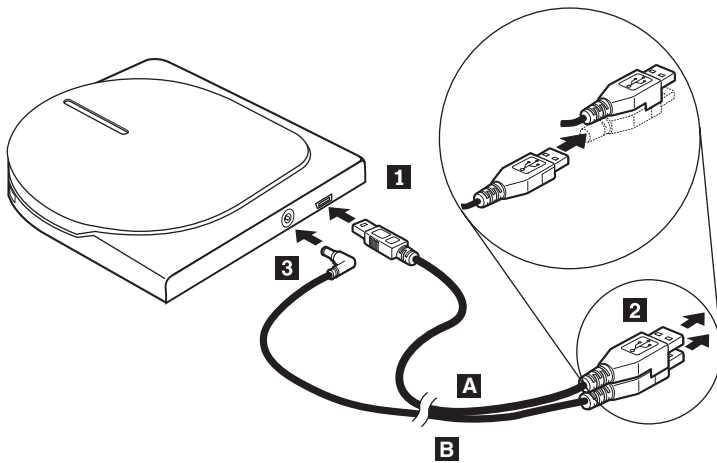

Figure 1-2. Configuration 2: auxiliary USB power configuration

1. Turn on your computer.
2. Using the USB cable **A**, insert the cable plug **1** into the USB connector of the drive.
3. Slide the two connectors **2** together and insert the stacked USB and auxiliary power connector into the powered USB 2.0 port on your computer (found on select IBM ThinkPad systems).
4. Connect the other end of the cable **B** to the drive by inserting the plug **3** into the DC IN connector on the Combo Drive.

Configuration 3: standard USB bus power configuration

The Combo Drive provides optimum performance under self power (configuration 1) or auxiliary power (configuration 2), however the drive will support all functions under standard USB bus power mode (read/write of CD-R/CD-RW media and read only of DVD media).

Note: The read/write function under this configuration is not within the USB standard regarding power specifications.

Requirements

- Standard USB cable and power cable assembly (shipped with this option); IBM Part Number 22P9216
- Two free USB ports available on your system

Specifications

Read/write CD and read only DVD media are supported.

Connecting the Combo Drive using configuration 3

To connect the Combo Drive to your system, complete the following procedure. Refer to Figure 1-3 during installation.

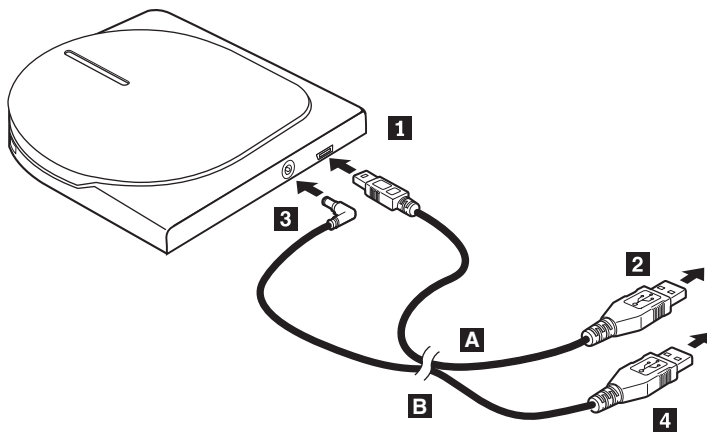
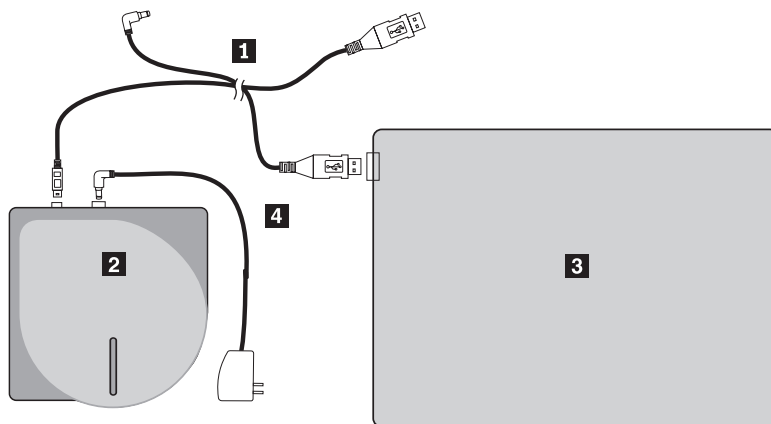

Figure 1-3. Configuration 3: USB standard bus power configuration

1. Turn on your computer.
2. Using the USB cable **A**, insert the cable plug **1** into the USB connector of the drive.
3. Plug the standard USB connector **2** into the USB port of your computer.
4. Using the USB cable **B**, insert the cable plug **3** into the DC IN connector of the drive.
5. Plug the standard USB connector **4** into the USB port of your computer.

Chapter 2. Cabling the Combo Drive to the ThinkPad computer

The following diagrams may be helpful when cabling the Combo Drive to your ThinkPad computer. Please note that these diagrams might differ slightly from your hardware.



- 1** USB cable and power cable assembly
- 2** Combo Drive
- 3** ThinkPad computer
- 4** Power adapter

Figure 2-1. Select IBM systems with AC power

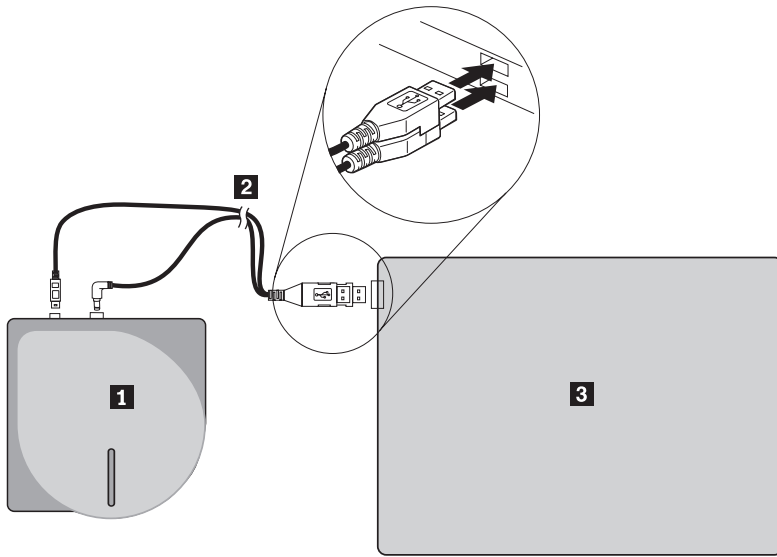

- 1** Combo Drive
- 2** IBM powered USB 2.0 cable assembly
- 3** ThinkPad computer

Figure 2-2. Select IBM systems with auxiliary USB powered port

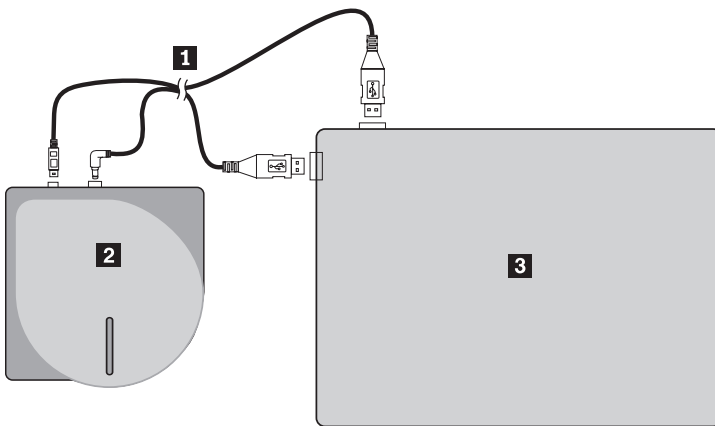

- 1** USB cable and power cable assembly
- 2** Combo Drive
- 3** ThinkPad computer

Figure 2-3. Standard USB cable assembly (left side)

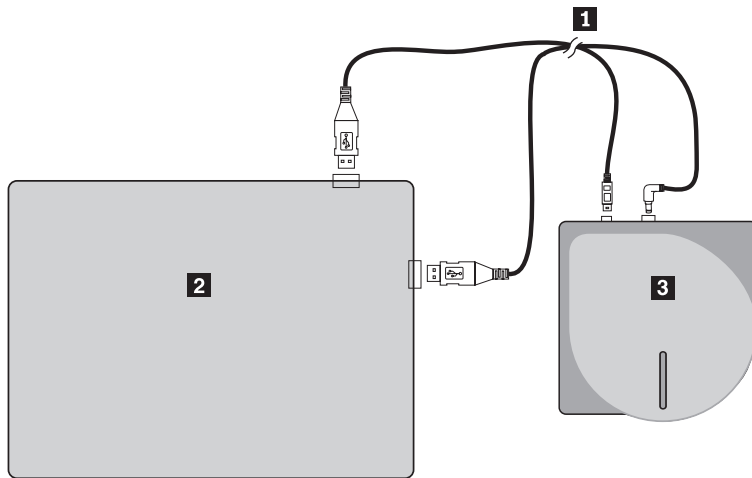

- 1** USB cable and power cable assembly
- 2** ThinkPad computer
- 3** Combo Drive

Figure 2-4. Standard USB cable assembly (right side)

Chapter 3. Features

The following list contains features of the IBM USB 2.0 CD-RW/DVD-ROM Combo Drive:

- **Easy connection**

Since this product incorporates the interface conforming to the USB 2.0 High Speed, it can be connected or disconnected to or from your computer easily even when the power of the computer is on. IBM Docks and Port Replicators with AC power are supported. Configuration 1 should be used when using IBM docks or port replicators.

- **Conformance to media manufactured by major media manufacturers**

This product is best tuned to almost all the CD and DVD media manufactured by major media manufacturers and the media written by this product realizes a very high write quality. Therefore, this drive can be used with little concern for compatibility issues.

- **Incorporation of the buffer underrun prevention function**

This product incorporates the buffer underrun prevention function which helps to prevent buffer underrun errors that cause a write failure onto the CD.

- **Top loading**

This product has a top loading mechanism that allows easy loading and ejection of a disc. The top cover can be opened manually or by using software that works with the computer.

- **Conformance to multiple standards**

This drive conforms with industry standard specifications for CD-RW and CD-R media. This drive is compliant with DVD+RW, DVD+R, DVD-RAM, DVD-RW, and DVD-R specifications (read only).

- **Power configurations**

This drive operates with the following power configurations:

- **Configuration 1: self power with AC adapter (full operation)**

When connected to AC power (use adapter shipped with the drive)

- **Configuration 2: auxiliary USB power (full operation)**

When connected to a powered USB 2.0 port on select IBM systems. Use cable assembly with special USB stacked connector included in the option.

- **Configuration 3: standard USB bus power (full operation)**

When connected to two standard USB ports (use cable assembly with two standard USB connectors)

This user's manual on the CD included with this option describes how to set up the Combo Drive, how to connect it to a personal computer, and how to operate it. Read the instruction manual of your computer as well.

The CD also includes software applications for use with the Combo Drive. They will automatically install by clicking on them.

Read this instruction manual carefully before use for proper handling and operations of the Combo Drive.

Chapter 4. Preparing to use the Combo Drive

Before using the Combo Drive, follow the procedure below:

1. Make sure the Combo Drive is properly connected to your ThinkPad computer.
2. Check the locations of the functions on the Combo Drive (refer to the figures below).
3. Insert the *IBM USB 2.0 CD-RW/DVD-ROM Combo Drive Software and User's Guide Super CD* that was shipped with this option to install the CD-R/CD-RW writing software or DVD read software.
4. Double-click on the application you want and follow the instructions on the screen.
5. Check that the drive operates normally and keep the enclosed warranty in a safe place after filling it in.

Check that nothing is placed on the top cover when ejecting a CD or DVD. When normal ejection is impossible, an error message may appear on your computer. When ejection is not performed normally, open the top cover manually and close it securely after removing anything that may be on the cover.

Following are the locations of the functions on the Combo Drive:

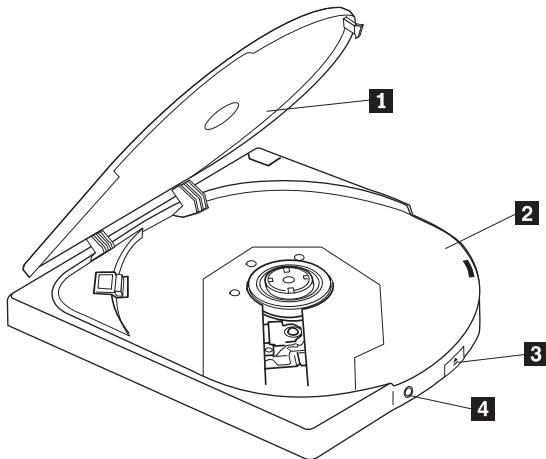

Figure 4-1. Front view of the Combo Drive

- 1** Top cover
- 2** Disc tray

The top cover must be closed to play a disc.
Set the media with the label face up on the disc tray.

3 Eject button

Press this button to open the top cover.

Attention: An electrical locking mechanism is used in this drive so that an erroneous operation does not open the top cover during write. Make sure that the power is on and the drive is not in a write operation before pressing the eject button to open the top cover.

If the top cover cannot be opened even when the eject button is pressed or if the top cover needs to be opened when power is not supplied from the AC adapter, use the emergency eject lever at the bottom of the drive.

Check that nothing is placed on the top cover when ejecting. When normal ejection is impossible, an error message may appear on your computer. When ejection is not performed normally, open the top cover manually and close it securely after removing anything that may be on the cover.

4 Power/Busy indicator

The green LED indicates the power status and the operation states of the drive.

- **LED is on:** during data read or seek
- **LED blinks slowly:** during data write
- **LED blinks quickly:** during disk recognition
- **LED is off:** when the drive is not being accessed (even though it may be connected to your system)

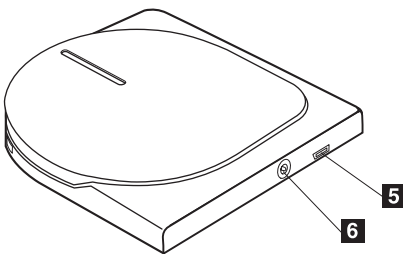

Figure 4-2. Rear view of the Combo Drive

- 5** USB connector
6 DC IN connector

Insert the plug of the provided dedicated USB cable. Connect the provided AC adapter or cable assembly DC IN connectors. This drive can also be used under USB Power Only with certain limitations (refer to “Configuration 3: standard USB bus power configuration” on page 1-5.)

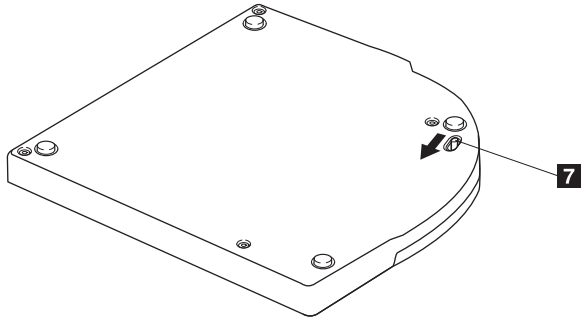

Figure 4-3. Bottom view of the Combo Drive

7 Emergency eject lever

When ejecting the media with the power off, slide the emergency eject lever to open the top cover.

Attention: Be sure the power is off when using the emergency eject lever. Use the eject button instead of the emergency eject lever except in an emergency.

Chapter 5. Combo Drive hardware installation and removal in Windows 2000 and Windows XP

Windows 2000 and Windows XP operating systems have the native drivers for the Combo Drive. Therefore, when this drive is connected, Windows will automatically install the appropriate driver and the drive will be ready to be used. You do not have to perform any special installation or removal procedures.

Attention:

- This drive will be recognized as "IBM CD-RW/DVD-ROM" by Windows Device Manager.
- In Windows 2000 operating systems, Service Pack 4 or later *must* be installed.

Removing the Combo Drive hardware

"Hot plug" is supported for the connection between the USB cable and the computer; therefore you don't need to turn off the computer when you remove the Combo Drive. Follow the procedure below for removing the Combo Drive for Windows 2000 and Windows XP.

Attention:

Do not remove and reconnect the drive from or to the computer in rapid succession. The drive may not be recognized. Reconnect the drive approximately 20 seconds after removing.

Use the Tray icon for this procedure.

Windows 2000

1. Exit the program that uses the drive.
2. Confirm that the Write indicator of the drive is off.
3. Click the **Remove** icon on the tray.



4. Select removing drive. In this case, select the drive name assigned to the drive (D: in this figure).

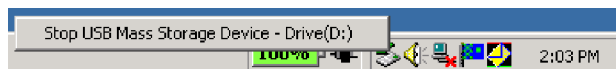

5. The Safe to Remove Hardware confirmation window appears. Click the **OK** button.

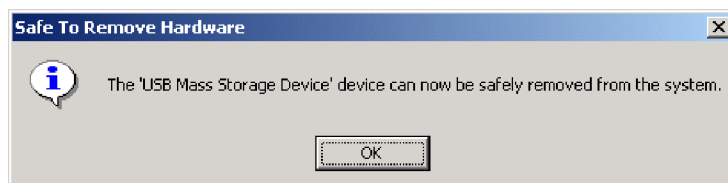

6. Remove the plug of the USB cable from the USB terminal of the computer.

Note: The message indicated above may differ depending on the versions of your operating system. Refer to the instruction manual for your computer or operating system for details.

Windows XP

1. Exit the program that uses the drive.
2. Confirm that the Write indicator of the drive is off.
3. Click the **Remove** icon on the tray.



4. Select removing drive. In this case, select the drive name assigned to the drive (D: in this figure).



5. The Safe to Remove Hardware confirmation window appears. Click the **OK** button.

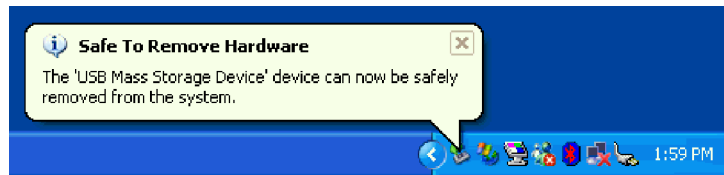

6. Remove the plug of the USB cable from the USB terminal of the computer.

Note: The message indicated above may differ depending on the versions of your operating system. Refer to the instruction manual for your computer or operating system for details.

Setting the media

1. Press the eject button of the drive to open the top cover.
2. Place the media on the tray with the label face upward. Align the center hole of the disc with the clamp at the center of the tray and fit the disc in securely by pressing the outer vicinity of the center hole.
3. Close the top cover gently and press the cover down until it is completely locked.
4. When the top cover is correctly closed, the media is recognized and made usable after the busy indicator blinks for some seconds.

Ejecting the media

1. Press the eject button of the drive to automatically open the top cover.
2. Lift the edge of the disc carefully from the tray while pressing the upper section of the clamp.
3. Close the top cover gently until the cover is completely closed. Check that the cover is securely locked.

Playing back the audio CD

Use Windows Media Player or audio CD playback software such as Microsoft CD Player for playing back the audio CD using the drive. The operation method differs depending on the software and versions. Refer to the operation manual of your computer or software for details.

Windows 2000

In Windows Media Player, you will find Digital Playback check box when you click the CD Audio tab in the Options window, as shown in the following figure.

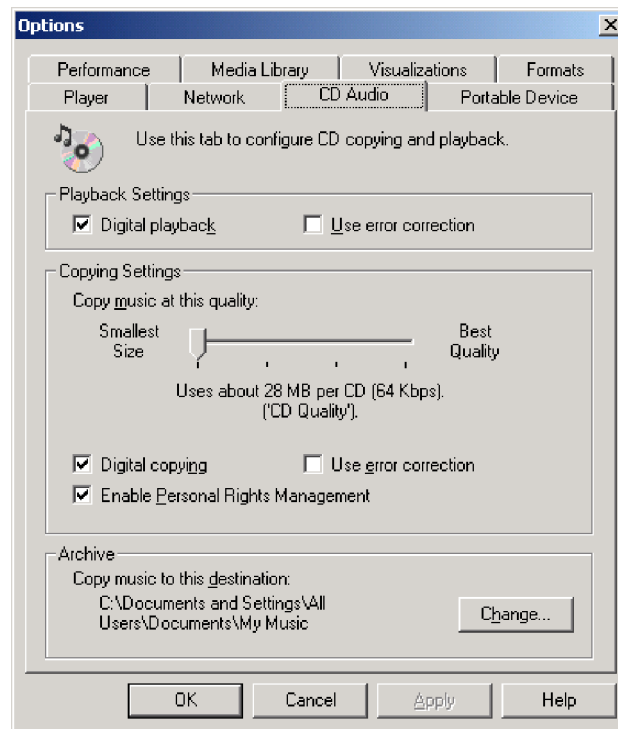

In addition, you will find the Enable Digital Music CD with this Combo Drive check box on the Combo Drive property on Device Manager, as shown in the figure below. When there is no setting item for the digital playback in your player

software, try the above setting.

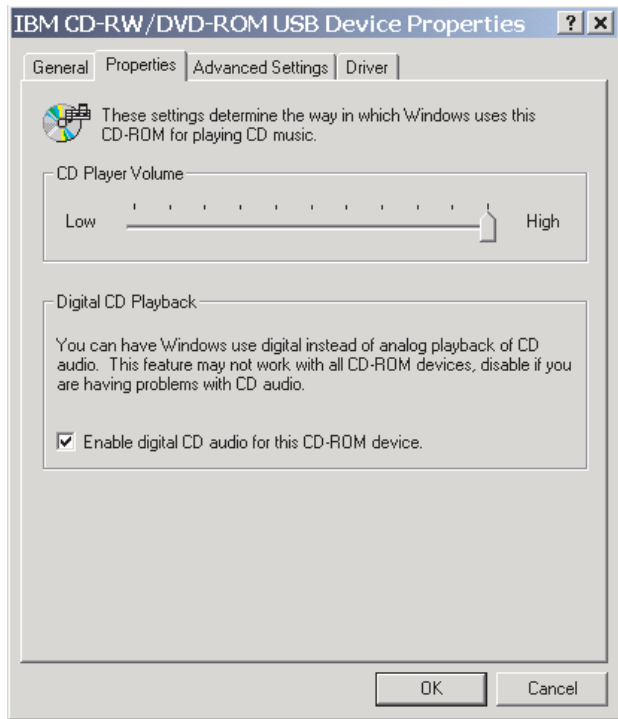

Note: The windows above may differ depending on the versions of your operating system. Refer to the instruction manual for your computer or operating system for details.

Windows XP

In Windows Media Player, you will find Digital Playback check box when you click the CD Audio tab in the Properties window, as shown in the following figure.

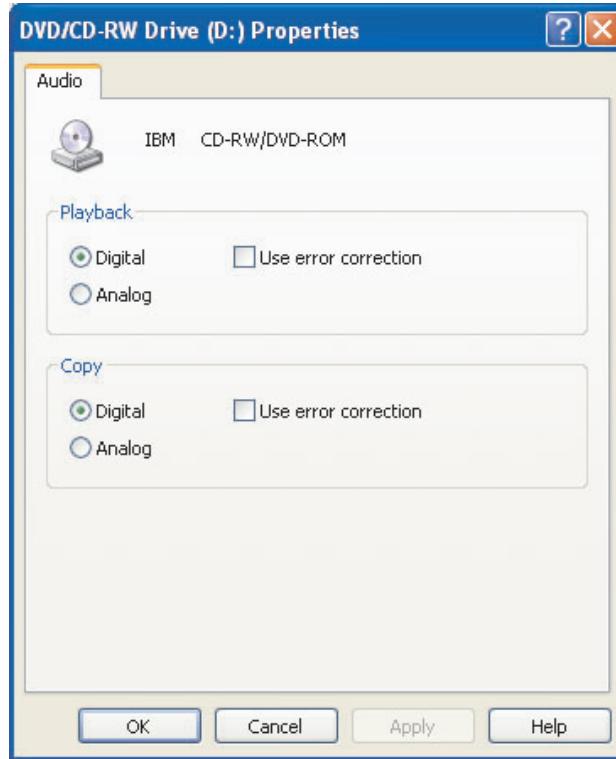

In addition, you will find the Enable Digital Music CD with this Combo Drive check box on the Combo Drive property on Device Manager, as shown in the figure below. When there is no setting item for the digital playback in your player software, try the above setting.

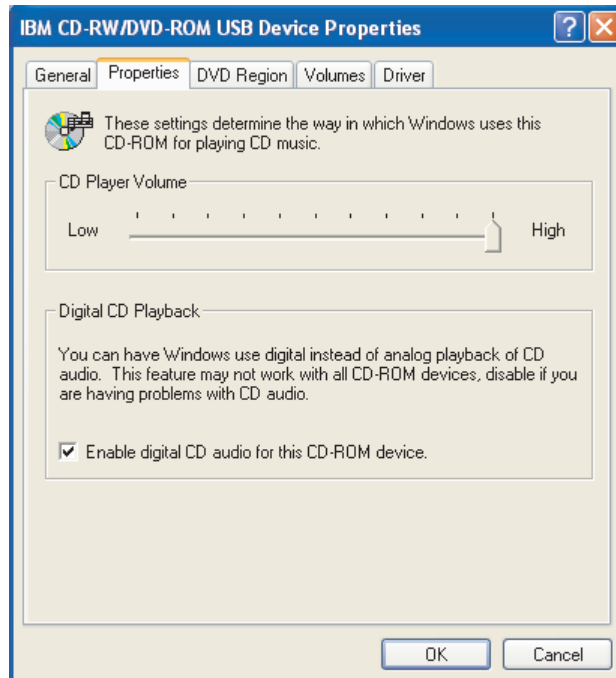

Note: The windows above may differ depending on the versions of your operating system. Refer to the instruction manual for your computer or operating system for details.

Chapter 6. Application software

Your *IBM USB 2.0 CD-RW/DVD-ROM Combo Drive Software and User's Guide Super CD* contains the following software:

- **IBM Drive Letter Access (DLA)**

This software enables you to write directly to CD-RW media only using the drive letter like you would if you were writing to a diskette. All disc format types can be formatted by DLA. With DLA, you can drag-and-drop files, create new directories, or save files from any application directly to your Combo Drive.

- **UDF reader**

This software enables you to install software for reading DVD-RAM, DVD-RW, and CD-RW media on computers with DVD drives. It also allows you to read DLA-created discs on systems without DLA installed.

- **IBM RecordNow**

IBM RecordNow is disc mastering software that allows you to create your own music or data discs from files on your computer, or from other disc media such as CDs or DVDs. Music discs created with IBM RecordNow will play on any CD player, whether it's at home, in your car, or through your computer's CD-ROM. IBM RecordNow also makes it easy to create data discs that can be read on any appropriate CD or DVD disc reader.

Note: Some DVD players cannot read CD-R media. Refer to the documentation that accompanied your drive for information on supported media.

IBM RecordNow guides you, step-by-step, through the recording process with simple Wizards and an intuitive user-interface.

Using IBM RecordNow you can create:

- Exact copies of existing discs - The Exact Copy feature makes a duplicate of your master disc, transferring the disc layout of the original disc to your CD-R or CD-RW.
- Discs of archived data from your hard drive – The Make a Data Disc feature is used to store electronic data, such as the files and applications that reside on your computer's hard drive. Unlike music discs, data discs are used to store files that are readable only by a computer, and cannot be played on your home or car stereo—even if audio files are on the disc.
- Music compilations from WAV, MP3, or WMA files, or from existing music discs – The Make a Music Disc feature creates custom music discs from files on your hard drive or your existing music discs. The CD music database feature can automatically tag your files with track information to help you sort through your collection.

Note: Please reference the IBM RecordNow On-line Help, for more information on how to Make an Exact copy, Create a Data Disc, or to Create an Audio disc with IBM RecordNow.

To start RecordNow, complete the following procedure:

1. Click **Start**.
2. Click **Programs**.
3. Click **IBM RecordNow**.
4. Click **RecordNow** to open the main recording software window.

- **Intervideo WinDVD**

This software enables you to play back DVD videos on your computer or to play video files from your hard disk drive.

Note: Some graphics adapters such as the FIREGL, Intergraph, and 3dLabs, do not support DVD video playback.

Chapter 7. Using the Combo Drive

This section provides information on how to handle, load, and care for DVDs and CDs and how to care for your Combo Drive.

Before you begin

For best results, review the following guidelines before using the drive:

- Do not move your ThinkPad computer while formatting or writing a disc as this might cause data errors. Also, minimize typing while formatting or writing to a disc, as this might also cause data errors.
- Keep the ThinkPad computer on a flat surface when writing to a disc.
- Turn screensavers off. Using a screensaver might interrupt the formatting and writing process.
- Do not put your ThinkPad computer into hibernation or suspend mode while writing to a disc.

Note: The read and write results of the drive depend upon the quality and characteristics of the DVD or CD media used.

Handling and caring for a disc

Carefully handle and clean discs, especially writable media types such as CD-R and CD-RW discs, so that they remain readable. You can prolong the life of your discs by using the following precautions:

- Always store discs in their original packaging.
- Always store discs out of direct sunlight.
- Always store discs away from direct heat sources.
- Remove discs from the computer when not in use.
- Check discs for cracks BEFORE each use.
IMPORTANT: Do not use discs that are cracked.
- Do not force discs into the computer or packaging.
- Do not bend or flex discs.
- Do not use commercial cleaners to clean discs.
- Do not write on the surface of discs.
- Handle discs by the edges or the center hole.
- Do not touch the surface of discs.
- To remove dust or fingerprints, wipe discs from the center to the edge with a soft, lint-free cloth.

Attention: Wiping a disc using a circular motion can cause data loss.
--

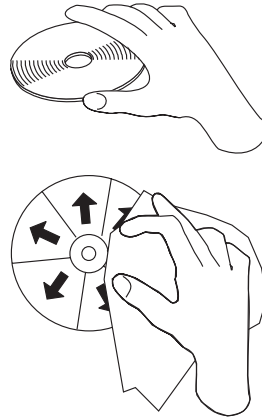

Caring for the Combo Drive

To protect your drive during operation, observe the following precautions:

- Remove the disc from the drive before moving the drive.
- Do not insert foreign objects into the drive.
- Do not stack objects on the drive.
- Do not remove the drive cover or attempt to service the drive.
- Do not operate the drive under any of the following conditions:
 - High temperature, high humidity, or direct sunlight
 - Excessive vibration, sudden shock, or inclined surface
 - Excessive dust

Cleaning the drive

Wipe off soil on the drive using a soft cloth. If soil is persistent, use a cloth dampened with a diluted neutral detergent after squeezing all the water out. If liquid is allowed into the drive, it may cause a serious malfunction, an electric shock or a fire. When cleaning with liquid, be sure to remove the provided AC adapter from the wall outlet after disconnecting the drive from your computer.

Do not apply solvents such as benzene or thinner. Chemical cleaners for home or industrial use may damage the coating of the drive.

Using the drive

This section contains information on using the Combo Drive.

Using single and double-sided DVD-RAM media

DVD-RAM media is available in single-sided and double-sided versions.

The 2.6 GB and 4.7 GB versions are single-sided. The 9.4 GB version is double-sided. To access the data on both sides of the media, you must remove the media from the drive, turn it over, and re-insert it into the drive.

Precautions for handling

Be careful when handling the removed disc. Debris, dust particles, fingerprints, smears, or scratches may impair recording and playback of the media. To clean

dust or other debris, use a CD Cleaning Kit. Use a soft, dry cloth to clean the disc. Do not use solvents to clean the disc surface. When labeling a disc, write only on the printed label side or the cartridge using a soft felt-tip marker. Keep out of direct sunlight, high temperatures, and humidity. Do not attach labels to either side of the disc.

Using the drive with CDs and DVDs

Complete the following procedure to read a data disc:

1. Turn on the computer.
2. Press the Eject button on the top of the drive.
3. Insert a disc in the tray with the label facing up.
4. Close the drive by gently closing the top cover.
5. Wait for the drive busy indicator to stop blinking and turn off.
6. Double-click the CD-ROM or DVD-RAM/DVD-R/DVD-RW icon.

Using the DVD player software

This section describes how to use and customize the DVD Player software. You can find current information on DVD Player software in the readme file on the *IBM USB 2.0 CD-RW/DVD-ROM Combo Drive Software and User's Guide Super CD*.

Using the DVD function

To use the DVD function, you need to install WinDVD (the DVD movie player program).

Enabling driver letter access (DLA)

Drive Letter Access (DLA) is provided so that you can write data to CD-RW media. CD-RW media can be written to many times.

To format and write to CD-RW media:

1. Insert a disc into the drive.
2. Double-click **My Computer**. Right-click the drive letter for the USB 2.0 Combo Drive.
3. Click **Format**. Formatting time will vary depending on the format process you use (quick or full).
4. After formatting is complete, you can drag and drop files to the USB 2.0 Combo Drive icon, or you can move files in Windows Explorer.

To use UDF formatted CD-RW media in other computers, a UDF reader is included on the *IBM USB 2.0 CD-RW/DVD-ROM Combo Drive Software and User's Guide Super CD*. To use the UDF reader, follow this procedure:

1. Insert the *IBM USB 2.0 CD-RW/DVD-ROM Combo Drive Software and User's Guide Super CD* into the CD or DVD drive of the computer you want to use the UDF formatted discs with.
2. Click **Start**.
3. Click **Run**.
4. Type `e:\UDF\language` where *e* is the drive letter of the USB 2.0 Combo Drive, and language is your language.
5. Click **OK**.

6. Double-click **SETUP.EXE** and follow the on-screen instructions.

Note: The UDF reader is only needed on systems that do not have another DLA program for CD-RW installed.

Installing WinDVD and viewing a DVD movie

To install WinDVD, go to the "Software" section of the *IBM USB 2.0 CD-RW/DVD-ROM Combo Drive Software and User's Guide Super CD*.

After you install the Combo Drive and WinDVD software, you can view a DVD movie. But first you need to set the DVD region code for your DVD content.

DVD region codes

DVD region codes help protect the contents of a DVD. The world is divided into six regions and specific content can be viewed only in the appropriate region. For example, content for Region 1 can be viewed only in the U.S. and Canada. WinDVD is also region-specific.

You can verify the region code of the content by looking at the region code symbol on the back of the content packaging.

Region code	Region
1	U.S., Canada
2	Europe, Middle East, South Africa, Japan
3	Southeast Asia, Taiwan, Korea
4	Latin America, Australia, New Zealand
5	Former Soviet Union, North Africa, India
6	People's Republic of China

Start WinDVD by inserting the DVD into the drive. The region code is automatically set and you can view the movie. This is the initial setting.

After the region code has been set, if you insert a DVD with a different region code, you are prompted to change the region code. You can change the region code from your initial setting up to four times.

After the region code has been changed from its initial setting four times, it is fixed and can no longer be changed. Thereafter, you can play DVD content only from that region.

To display the region code status, click the **WinDVD Properties** button on the WinDVD user interface. The **General** tab contains this information.

To change the region code, do the following:

1. Turn on your computer and start your operating system.
2. Click **Start**.
3. Select **Programs**.
4. Click **Intervideo WinDVD**.
5. Click the **Properties** icon to open the **Properties** window.
6. Click the **General Properties** tab.

7. Insert a single region DVD of the new region.
8. Select the correct region code for your country.
9. Click **OK**.

Starting WinDVD

To start WinDVD, complete the following procedure:

1. Click **Start**.
2. Click **Programs**.
3. Click **InterVideo WinDVD**.
4. Click **InterVideo WinDVD** to open the DVD movie player window.

For more information on how to play the DVD movie player, refer to the WinDVD help information on the *IBM USB 2.0 CD-RW/DVD-ROM Combo Drive Software and User's Guide Super CD*. If you want to watch a DVD movie on your TV, refer to the online information provided with your computer.

Notes:

1. Your computer has been configured to provide the highest quality audio and video playback obtainable with the available system resources. You can alter the default settings by changing the video resolution setting within the Control Panel. Some systems do not have enough resources to provide full-quality audio and video playback at all resolution settings. If you experience poor playback performance, adjust the resolution to a lower setting.
2. Audio or video streams are decoded by software. The audio and video subsystems need to be fully functional and enabled.

Using the CD-R and CD-RW function

The Combo Drive can write to both CD-R and CD-RW discs. CD-R discs cannot be erased, but can be used with standard CD-ROM drives and CD players.

You can use CD-R discs to record audio tracks, store data, archive files, and copy files from another CD.

CD-RW discs can be erased and rewritten, but can be used only with newer MR- and CD-RW-compatible CD-ROM and DVD-ROM drives. You can use CD-RW discs to back up, store, and update files or to copy files from another CD.

Notes:

1. CD-R discs are playable on audio CD players. CD-RW discs are not playable on most audio CD players.
2. The software included with this drive does **not** enable the drive CD-recording capabilities with DOS, Windows 3.x, or IBM OS/2[®] operating systems.

For more information on using the software, refer to the IBM RecordNow and IBM DLA help information on the *IBM USB 2.0 CD-RW/DVD-ROM Combo Drive Software and User's Guide Super CD*.

Using the DVD+R, DVD+RW, DVD-R, DVD-RW, and DVD-RAM function (read only)

The Combo Drive can read DVD+R, DVD+RW, DVD-R, DVD-RW, and DVD-RAM discs.

Backing up a CD

To copy a commercial CD you must own the copyright or obtain permission from the copyright owner. If you do not own the copyright or do not obtain permission from the copyright owner, you might be violating copyright law and might be subject to payment of damages or other remedies. For more information on copyright law, consult your legal advisor.

Problem solving

Computer problems can be caused by hardware, software, or user error. The information in this section might be useful to help you solve problems or to gather helpful information you can pass on to a service technician. You might also need to refer to your computer, operating-system, or sound-adaptor publications.

Review the following list for any problem descriptions that might fit your situation.

You cannot create a multisession disc.

Be sure that there is enough space left on the disc for another session. Writing a session requires lead-in and lead-out space (about 15 MB) in addition to the data that is recorded.

You cannot successfully write to a CD-R or CD-RW disc.

Take the following actions:

1. Verify that the process is not being interrupted by a screen saver, an antivirus program, an Internet or e-mail program, or other software. Disable the functions that might interrupt the write operation.
2. Verify that the hard disk has been defragmented.
3. Consult the hard disk drive manufacturer or vendor if an older hard disk drive is conducting a thermal recalibration during a write operation.
4. Replace the disc if it is bad or scratched.
5. Disable the Windows Auto Insert Notify function on your CD-ROM and CD-RW drives.

You cannot eject a disc.

Take the following actions after ensuring that the drive is not in the process of writing to a disc:

1. Eject the disc through software.
2. Use the Eject button.
3. Turn off the computer. Wait 45 seconds; then turn on the computer and try using the Eject button again.
4. If other methods do not work, use the emergency eject lever. For more information, see Chapter 4, "Preparing to use the Combo Drive," on page 4-1.

You cannot read from the CD disc after successfully writing to it.

Take the following actions:

1. If you can read the CD disc in another CD player or you can see previous sessions, the directory information might be damaged on the volume, making it unreadable. To get ideas for troubleshooting, check the documentation that comes with the software.
2. You might have a damaged CD-R or CD-RW disc. Try a new disc or another brand of CD disc.
3. If you can read from a CD-RW disc in the writing drive, but not in another MR drive, be sure that a UDF Reader program is installed in the computer.
4. Avoid writing at the slower 1X speed unless required by your computer.

Appendix A. Product specifications

This appendix includes the following information:

- Physical specifications
- Power requirements
- Environmental requirements
- Read speeds
- Write speeds

Physical specifications

The physical specifications¹ of the drive are listed in the following table.

Physical specification	
Height	15 mm (0.6 in.)
Width	135.5 mm (5.33 in.)
Length	139.5 mm (5.49 in.)
Weight	250 g (0.55 lb)

Power requirements

The following table lists the power specifications by voltage level for the drive. The power specifications are measured at the drive power connector and are nominal values.

Power specifications	Voltage	Average	Maximum
AC/Aux Power	7.5V - 18V dc	750 mA	1.5 A
USB Standard Bus Power	5V dc	800 mA	1.5 A

Environmental requirements

Specification	Operational	Nonoperational
Temperature (noncondensing)	+5° C to +40° C (+41° F to +104° F)	-20° C to +60° C (-4° F to +140° F)
Relative humidity (noncondensing)	8% to 80%	5% to 95%

1. Product-description data represents IBM's design objectives and is provided for comparative purposes; actual results might vary based on a variety of factors. This product data does not constitute a warranty. Data is subject to change without notice.

Read speeds

Media	All power modes
DVD-ROM (single layer)	8X Max.
DVD-ROM (dual layer)	4X Max.
DVD-R (4.7 GB)	4X Max.
DVD-RW (4.7 GB)	4X Max.
DVD-video	4X Max.
DVD-RAM (4.7/9.4 GB)	2X Max.
DVD-RAM (2.6 GB)	1X Max.
DVD+R	4X Max.
DVD+RW	4X Max.
CD-ROM	24X Max.
CD-R	24x Max.
CD-RW	24X Max.
CD-DA (DAE)	4X

Write speeds

Media	All power modes
CD-R	24X Max.
CD-RW	24X Max.

Appendix B. Service and Support

The following information describes the technical support that is available for your product, during the warranty period or throughout the life of the product. Refer to your IBM Statement of Limited Warranty for a full explanation of IBM warranty terms.

Online technical support

Online technical support is available during the life of your product through the Personal Computing Support Web site at:

<http://www.ibm.com/pc/support>

During the warranty period, assistance for replacement or exchange of defective components is available. In addition, if your IBM option is installed in an IBM computer, you might be entitled to service at your location. Your technical support representative can help you determine the best alternative.

Telephone technical support

Installation and configuration support through the IBM Support Center will be withdrawn or made available for a fee, at IBM's discretion, 90 days after the option has been withdrawn from marketing. Additional support offerings, including step-by-step installation assistance, are available for a nominal fee.

To assist the technical support representative, have available as much of the following information as possible:

- Option name
- Option number
- Proof of purchase
- Computer manufacturer, model, serial number (if IBM), and manual
- Exact wording of the error message (if any)
- Description of the problem
- Hardware and software configuration information for your system

If possible, be at your computer. Your technical support representative might want to walk you through the problem during the call.

For the support telephone number and support hours by country, refer to the following table. If the number for your country or region is not listed, contact your IBM reseller or IBM marketing representative. Response time may vary depending on the number and nature of the calls received.

Phone numbers are subject to change without notice. For the latest phone number list, go to <http://www.ibm.com/pc/support> and click **Support Phone List**.

Country or Region	Telephone Number	Country or Region	Telephone Number
Argentina	0800-666-0011	Malaysia	03-7727-7800
Australia	1300-130-426	Mexico	001-866-434-2080

Country or Region	Telephone Number	Country or Region	Telephone Number
Austria	01-24592-5901	Netherlands	020-514-5770
Belgium	Dutch 02-210-9820 French 02-210-9800	New Zealand	0800-446-149
Bolivia	0800-0189	Norway	66 81 11 00
Brazil	55-11-3889-8986	Peru	0-800-50-866
Canada	1-800-565-3344 Toronto 416-383-3344	Philippines	632-995-2225
Chile	800-224-488	Portugal	21-791 51 47
China (PRC)	800-810-1818	Russia	095-940-2000
China (Hong Kong S.A.R.)	852-2825-7799	Singapore	1800-840-9911
Columbia	980-912-3021	Spain	91-662 49 16
Denmark	45 20 82 00	Sweden	08-477 4420
Ecuador	1-800-426911 (option #4)	Switzerland	058-333-09-00
Finland	09-459 69 60	Taiwan	886-2-2725-9799
France	02 38 55 74 50	Thailand	66-2-273-4000
Germany	07032-1549 201	Turkey	00-800-446-32-041
Indonesia	021-523-8535	United Kingdom	0-1475-555 055
Ireland	01-815-9202	United States	1-800-426-7378
Italy	02-7031-6101	Uruguay	000-411-005-6649
Japan	Consumer customers 0120-887-870 Business customers 0120-887-874	Venezuela	0-800-100-2011
Luxembourg	298-977 5063	Vietnam	848-8295-160

Appendix C. IBM Statement of Limited Warranty - Z125-4753-07 - 11/2002

Part 1 - General Terms

This Statement of Limited Warranty includes Part 1 - General Terms, Part 2 - Country-unique Terms, and Part 3 - Warranty Information. The terms of Part 2 replace or modify those of Part 1. The warranties provided by IBM in this Statement of Limited Warranty apply only to Machines you purchase for your use, and not for resale. The term "Machine" means an IBM machine, its features, conversions, upgrades, elements, or accessories, or any combination of them. The term "Machine" does not include any software programs, whether pre-loaded with the Machine, installed subsequently or otherwise. Nothing in this Statement of Limited Warranty affects any statutory rights of consumers that cannot be waived or limited by contract.

What this Warranty Covers

IBM warrants that each Machine 1) is free from defects in materials and workmanship and 2) conforms to IBM's Official Published Specifications ("Specifications") which are available on request. The warranty period for the Machine starts on the original Date of Installation and is specified in Part 3 - Warranty Information. The date on your invoice or sales receipt is the Date of Installation unless IBM or your reseller informs you otherwise. Many features, conversions, or upgrades involve the removal of parts and their return to IBM. A part that replaces a removed part will assume the warranty service status of the removed part. Unless IBM specifies otherwise, these warranties apply only in the country or region in which you purchased the Machine.

THESE WARRANTIES ARE YOUR EXCLUSIVE WARRANTIES AND REPLACE ALL OTHER WARRANTIES OR CONDITIONS, EXPRESS OR IMPLIED, INCLUDING, BUT NOT LIMITED TO, THE IMPLIED WARRANTIES OR CONDITIONS OF MERCHANTABILITY AND FITNESS FOR A PARTICULAR PURPOSE. SOME STATES OR JURISDICTIONS DO NOT ALLOW THE EXCLUSION OF EXPRESS OR IMPLIED WARRANTIES, SO THE ABOVE EXCLUSION MAY NOT APPLY TO YOU. IN THAT EVENT, SUCH WARRANTIES ARE LIMITED IN DURATION TO THE WARRANTY PERIOD. NO WARRANTIES APPLY AFTER THAT PERIOD. SOME STATES OR JURISDICTIONS DO NOT ALLOW LIMITATIONS ON HOW LONG AN IMPLIED WARRANTY LASTS, SO THE ABOVE LIMITATION MAY NOT APPLY TO YOU.

What this Warranty Does not Cover

This warranty does not cover the following:

- any software programs, whether pre-loaded or shipped with the Machine, or installed subsequently;
- failure resulting from misuse (including but not limited to use of any Machine capacity or capability, other than that authorized by IBM in writing), accident, modification, unsuitable physical or operating environment, or improper maintenance by you;
- failure caused by a product for which IBM is not responsible; and

- any non-IBM products, including those that IBM may procure and provide with or integrate into an IBM Machine at your request.

The warranty is voided by removal or alteration of identification labels on the Machine or its parts.

IBM does not warrant uninterrupted or error-free operation of a Machine.

Any technical or other support provided for a Machine under warranty, such as assistance via telephone with "how-to" questions and those regarding Machine set-up and installation, is provided **WITHOUT WARRANTIES OF ANY KIND**.

How to Obtain Warranty Service

If the Machine does not function as warranted during the warranty period, contact IBM or your reseller to obtain warranty service. If you do not register the Machine with IBM, you may be required to present proof of purchase as evidence of your entitlement to warranty service.

What IBM Will Do to Correct Problems

When you call for service, you must follow the problem determination and resolution procedures that IBM specifies. A technician will attempt to make an initial diagnosis of your problem and help you resolve it over the telephone.

The type of warranty service applicable to your Machine is specified in Part 3 - Warranty Information.

You are responsible for downloading and installing designated Machine Code (microcode, basic input/output system code (called "BIOS"), utility programs, device drivers, and diagnostics delivered with an IBM Machine) and other software updates from an IBM Internet Web site or from other electronic media, and following the instructions that IBM provides.

If your problem can be resolved with a Customer Replaceable Unit ("CRU") (e.g., keyboard, mouse, speaker, memory, hard disk drive and other easily replaceable parts), IBM will ship these parts to you for replacement by you.

If the Machine does not function as warranted during the warranty period and your problem cannot be resolved over the telephone, through your application of Machine Code or software updates, or with a CRU, IBM or your reseller, if approved by IBM to provide warranty service, will either, at its discretion, 1) repair it to make it function as warranted, or 2) replace it with one that is at least functionally equivalent. If IBM is unable to do either, you may return the Machine to your place of purchase and your money will be refunded.

IBM or your reseller will also manage and install selected engineering changes that apply to the Machine.

Exchange of a Machine or Part

When the warranty service involves the exchange of a Machine or part, the item IBM or your reseller replaces becomes its property and the replacement becomes yours. You represent that all removed items are genuine and unaltered. The replacement may not be new, but will be in good working order and at least

functionally equivalent to the item replaced. The replacement assumes the warranty service status of the replaced item.

Your Additional Responsibilities

Before IBM or your reseller exchanges a Machine or part, you agree to remove all features, parts, options, alterations, and attachments not under warranty service.

You also agree to:

1. ensure that the Machine is free of any legal obligations or restrictions that prevent its exchange;
2. obtain authorization from the owner to have IBM or your reseller service a Machine that you do not own; and
3. where applicable, before service is provided:
 - a. follow the service request procedures that IBM or your reseller provides;
 - b. backup or secure all programs, data, and funds contained in the Machine;
 - c. IBM or your reseller with sufficient, free, and safe access to your facilities to permit IBM to fulfill its obligations; and
 - d. inform IBM or your reseller of changes in the Machine's location.
4. (a) ensure all information about identified or identifiable individuals (Personal Data) is deleted from the Machine (to the extent technically possible), (b) allow IBM, your reseller or an IBM supplier to process on your behalf any remaining Personal Data as IBM or your reseller considers necessary to fulfill its obligations under this Statement of Limited Warranty (which may include shipping the Machine for such processing to other IBM service locations around the world), and (c) ensure that such processing complies with any laws applicable to such Personal Data.

Limitation of Liability

IBM is responsible for loss of, or damage to, your Machine only while it is 1) in IBM's possession or 2) in transit in those cases where IBM is responsible for the transportation charges.

Neither IBM nor your reseller are responsible for any of your confidential, proprietary or personal information contained in a Machine which you return to IBM for any reason. You should remove all such information from the Machine prior to its return.

Circumstances may arise where, because of a default on IBM's part or other liability, you are entitled to recover damages from IBM. In each such instance, regardless of the basis on which you are entitled to claim damages from IBM (including fundamental breach, negligence, misrepresentation, or other contract or tort claim), except for any liability that cannot be waived or limited by applicable laws, IBM is liable for no more than

1. damages for bodily injury (including death) and damage to real property and tangible personal property; and
2. the amount of any other actual direct damages, up to the charges (if recurring, 12 months' charges apply) for the Machine that is subject of the claim. For purposes of this item, the term "Machine" includes Machine Code and Licensed Internal Code ("LIC").

This limit also applies to IBM's suppliers and your reseller. It is the maximum for which IBM, its suppliers, and your reseller are collectively responsible.

UNDER NO CIRCUMSTANCES IS IBM, ITS SUPPLIERS OR RESELLERS LIABLE FOR ANY OF THE FOLLOWING EVEN IF INFORMED OF THEIR POSSIBILITY: 1) THIRD PARTY CLAIMS AGAINST YOU FOR DAMAGES (OTHER THAN THOSE UNDER THE FIRST ITEM LISTED ABOVE); 2) LOSS OF, OR DAMAGE TO, DATA; 3) SPECIAL, INCIDENTAL, OR INDIRECT DAMAGES OR FOR ANY ECONOMIC CONSEQUENTIAL DAMAGES; OR 4) LOST PROFITS, BUSINESS REVENUE, GOODWILL OR ANTICIPATED SAVINGS. SOME STATES OR JURISDICTIONS DO NOT ALLOW THE EXCLUSION OR LIMITATION OF INCIDENTAL OR CONSEQUENTIAL DAMAGES, SO THE ABOVE LIMITATION OR EXCLUSION MAY NOT APPLY TO YOU. SOME STATES OR JURISDICTIONS DO NOT ALLOW LIMITATIONS ON HOW LONG AN IMPLIED WARRANTY LASTS, SO THE ABOVE LIMITATION MAY NOT APPLY TO YOU.

Governing Law

Both you and IBM consent to the application of the laws of the country in which you acquired the Machine to govern, interpret, and enforce all of your and IBM's rights, duties, and obligations arising from, or relating in any manner to, the subject matter of this Statement of Limited Warranty, without regard to conflict of law principles.

THESE WARRANTIES GIVE YOU SPECIFIC LEGAL RIGHTS AND YOU MAY ALSO HAVE OTHER RIGHTS WHICH VARY FROM STATE TO STATE OR JURISDICTION TO JURISDICTION.

Jurisdiction

All of our rights, duties, and obligations are subject to the courts of the country in which you acquired the Machine.

Part 2 - Country-unique Terms

AMERICAS

ARGENTINA

Governing Law: *The following is added after the first sentence:*

Any litigation arising from this Statement of Limited Warranty will be settled exclusively by the Ordinary Commercial Court of the city of Buenos Aires.

BRAZIL

Governing Law: *The following is added after the first sentence:*

Any litigation arising from this Statement of Limited Warranty will be settled exclusively by the court of Rio de Janeiro, RJ.

Peru

Limitation of Liability: *The following is added at the end of this section:*

In accordance with Article 1328 of the Peruvian Civil Code the limitations and exclusions specified in this section will not apply to damages caused by IBM's willful misconduct ("dolo") or gross negligence ("culpa inexcusable").

NORTH AMERICA

How to Obtain Warranty Service: *The following is added to this Section:*
To obtain warranty service from IBM in Canada or the United States, call 1-800-IBM-SERV (426-7378).

CANADA

Limitation of Liability: *The following replaces item 1 of this section:*

1. damages for bodily injury (including death) or physical harm to real property and tangible personal property caused by IBM's negligence; and

Governing Law: *The following replaces "laws of the country in which you acquired the Machine" in the first sentence:*
laws in the Province of Ontario.

UNITED STATES

Governing Law: *The following replaces "laws of the country in which you acquired the Machine" in the first sentence:*
laws of the State of New York.

ASIA PACIFIC

AUSTRALIA

What this Warranty Covers: *The following paragraph is added to this Section:*
The warranties specified in this Section are in addition to any rights you may have under the Trade Practices Act 1974 or other similar legislation and are only limited to the extent permitted by the applicable legislation.

Limitation of Liability: *The following is added to this Section:*
Where IBM is in breach of a condition or warranty implied by the Trade Practices Act 1974 or other similar legislation, IBM's liability is limited to the repair or replacement of the goods or the supply of equivalent goods. Where that condition or warranty relates to right to sell, quiet possession or clear title, or the goods are of a kind ordinarily acquired for personal, domestic or household use or consumption, then none of the limitations in this paragraph apply.

Governing Law: *The following replaces "laws of the country in which you acquired the Machine" in the first sentence:*
laws of the State or Territory.

CAMBODIA, LAOS, AND VIETNAM

Governing Law: *The following replaces "laws of the country in which you acquired the Machine" in the first sentence:*
laws of the State of New York, United States of America.

CAMBODIA, INDONESIA, LAOS, AND VIETNAM

Arbitration: The following is added under this heading:

Disputes arising out of or in connection with this Statement of Limited Warranty shall be finally settled by arbitration which shall be held in Singapore in accordance with the Arbitration Rules of Singapore International Arbitration Center ("SIAC Rules") then in effect. The arbitration award shall be final and binding for the parties without appeal and shall be in writing and set forth the findings of fact and the conclusions of law.

The number of arbitrators shall be three, with each side to the dispute being entitled to appoint one arbitrator. The two arbitrators appointed by the parties shall appoint a third arbitrator who shall act as chairman of the proceedings. Vacancies in the post of chairman shall be filled by the president of the SIAC. Other vacancies shall be filled by the respective nominating party. Proceedings shall continue from the stage they were at when the vacancy occurred.

If one of the parties refuses or otherwise fails to appoint an arbitrator within 30 days of the date the other party appoints its, the first appointed arbitrator shall be the sole arbitrator, provided that the arbitrator was validly and properly appointed.

All proceedings shall be conducted, including all documents presented in such proceedings, in the English language. The English language version of this Statement of Limited Warranty prevails over any other language version.

HONG KONG S.A.R. OF CHINA AND MACAU S.A.R. OF CHINA

Governing Law: *The following replaces "laws of the country in which you acquired the Machine" in the first sentence:*

laws of Hong Kong Special Administrative Region of China.

INDIA

Limitation of Liability: *The following replaces items 1 and 2 of this Section:*

1. liability for bodily injury (including death) or damage to real property and tangible personal property will be limited to that caused by IBM's negligence; and
2. as to any other actual damage arising in any situation involving nonperformance by IBM pursuant to, or in any way related to the subject of this Statement of Limited Warranty, , the charge paid by you for the individual Machine that is the subject of the claim. For purposes of this item, the term "Machine" includes Machine Code and Licensed Internal Code ("LIC").

Arbitration: *The following is added under this heading :*

Disputes arising out of or in connection with this Statement of Limited Warranty shall be finally settled by arbitration which shall be held in Bangalore, India in accordance with the laws of India then in effect. The arbitration award shall be final and binding for the parties without appeal and shall be in writing and set forth the findings of fact and the conclusions of law.

The number of arbitrators shall be three, with each side to the dispute being entitled to appoint one arbitrator. The two arbitrators appointed by the parties shall appoint a third arbitrator who shall act as chairman of the proceedings. Vacancies in the post of chairman shall be filled by the president of the Bar Council of India. Other vacancies shall be filled by the respective nominating party. Proceedings shall continue from the stage they were at when the vacancy occurred.

If one of the parties refuses or otherwise fails to appoint an arbitrator within 30 days of the date the other party appoints its, the first appointed arbitrator shall be the sole arbitrator, provided that the arbitrator was validly and properly appointed.

All proceedings shall be conducted, including all documents presented in such proceedings, in the English language. The English language version of this Statement of Limited Warranty prevails over any other language version.

JAPAN

Governing Law: *The following sentence is added to this section:*

Any doubts concerning this Statement of Limited Warranty will be initially resolved between us in good faith and in accordance with the principle of mutual trust.

MALAYSIA

Limitation of Liability: *The word "SPECIAL" in item 3 of the fifth paragraph is deleted.*

NEW ZEALAND

What this Warranty Covers: *The following paragraph is added to this section:*

The warranties specified in this section are in addition to any rights you may have under the Consumer Guarantees Act 1993 or other legislation which cannot be excluded or limited. The Consumer Guarantees Act 1993 will not apply in respect of any goods which IBM provides, if you require the goods for the purposes of a business as defined in that Act.

Limitation of Liability: *The following is added to this section:*

Where Machines are not acquired for the purposes of a business as defined in the Consumer Guarantees Act 1993, the limitations in this section are subject to the limitations in that Act.

PEOPLE'S REPUBLIC OF CHINA (PRC)

Governing Law: *The following replaces "laws of the country in which you acquired the Machine" in the first sentence:*

laws of the State of New York, United States of America (except when local law requires otherwise).

PHILIPPINES

Limitation of Liability: *Item 3 in the fifth paragraph is replaced by the following:*

SPECIAL (INCLUDING NOMINAL AND EXEMPLARY DAMAGES), MORAL, INCIDENTAL, OR INDIRECT DAMAGES FOR ANY ECONOMIC CONSEQUENTIAL DAMAGES; OR

Arbitration: The following is added under this heading

Disputes arising out of or in connection with this Statement of Limited Warranty shall be finally settled by arbitration which shall be held in Metro Manila, Philippines in accordance with the laws of the Philippines then in effect. The

arbitration award shall be final and binding for the parties without appeal and shall be in writing and set forth the findings of fact and the conclusions of law.

The number of arbitrators shall be three, with each side to the dispute being entitled to appoint one arbitrator. The two arbitrators appointed by the parties shall appoint a third arbitrator who shall act as chairman of the proceedings. Vacancies in the post of chairman shall be filled by the president of the Philippine Dispute Resolution Center, Inc.. Other vacancies shall be filled by the respective nominating party. Proceedings shall continue from the stage they were at when the vacancy occurred.

If one of the parties refuses or otherwise fails to appoint an arbitrator within 30 days of the date the other party appoints its, the first appointed arbitrator shall be the sole arbitrator, provided that the arbitrator was validly and properly appointed.

All proceedings shall be conducted, including all documents presented in such proceedings, in the English language. The English language version of this Statement of Limited Warranty prevails over any other language version.

SINGAPORE

Limitation of Liability: The words "SPECIAL" and "ECONOMIC" in item 3 in the fifth paragraph are deleted.

EUROPE, MIDDLE EAST, AFRICA (EMEA)

THE FOLLOWING TERMS APPLY TO ALL EMEA COUNTRIES:

The terms of this Statement of Limited Warranty apply to Machines purchased from IBM or an IBM reseller.

How to Obtain Warranty Service: If you purchase a Machine in Austria, Belgium, Cyprus, Denmark, Estonia, Finland, France, Germany, Greece, Iceland, Ireland, Italy, Latvia, Liechtenstein, Lithuania, Luxembourg, Monaco, Netherlands, Norway, Portugal, Spain, San Marino, Sweden, Switzerland, United Kingdom or Vatican State, you may obtain warranty service for that Machine in any of those countries from either (1) an IBM reseller approved to perform warranty service or (2) from IBM, provided the Machine has been announced and made available by IBM in the country in which you wish to obtain service. If you purchased a Personal Computer Machine in Albania, Armenia, Belarus, Bosnia and Herzegovina, Bulgaria, Croatia, Czech Republic, Georgia, Hungary, Kazakhstan, Kyrgyzstan, Federal Republic of Yugoslavia, Former Yugoslav Republic of Macedonia (FYROM), Moldova, Poland, Romania, Russia, Slovak Republic, Slovenia, or Ukraine, you may obtain warranty service for that Machine in any of those countries from either (1) an IBM reseller approved to perform warranty service or (2) from IBM.

If you purchase a Machine in a Middle Eastern or African country, you may obtain warranty service for that Machine from the IBM entity within the country of purchase, if that IBM entity provides warranty service in that country, or from an IBM reseller, approved by IBM to perform warranty service on that Machine in that country. Warranty service in Africa is available within 50 kilometers of an IBM approved service provider. You are responsible for transportation costs for Machines located outside 50 kilometers of an IBM approved service provider.

*Add the following paragraph in **Western Europe** (Austria, Belgium, Cyprus, Denmark, Finland, France, Germany, Greece, Iceland, Ireland, Italy, Liechtenstein, Luxembourg, Monaco, Netherlands, Norway, Portugal, Spain, San Marino, Sweden, Switzerland, United Kingdom, Vatican State):*

The warranty for Machines acquired in Western Europe shall be valid and applicable in all Western Europe countries provided the Machines have been announced and made available in such countries.

Governing Law:

The phrase "the laws of the country in which you acquired the Machine" is replaced by:

1) "the laws of Austria" in **Albania, Armenia, Azerbaijan, Belarus, Bosnia-Herzegovina, Bulgaria, Croatia, Georgia, Hungary, Kazakhstan, Kyrgyzstan, FYR Macedonia, Moldova, Poland, Romania, Russia, Slovakia, Slovenia, Tajikistan, Turkmenistan, Ukraine, Uzbekistan, and FR Yugoslavia;** 2) "the laws of France" in **Algeria, Benin, Burkina Faso, Cameroon, Cape Verde, Central African Republic, Chad, Comoros, Congo Republic, Djibouti, Democratic Republic of Congo, Equatorial Guinea, French Guiana, French Polynesia, Gabon, Gambia, Guinea, Guinea-Bissau, Ivory Coast, Lebanon, Madagascar, Mali, Mauritania, Mauritius, Mayotte, Morocco, New Caledonia, Niger, Reunion, Senegal, Seychelles, Togo, Tunisia, Vanuatu, and Wallis & Futuna;** 3) "the laws of Finland" in **Estonia, Latvia, and Lithuania;** 4) "the laws of England" in **Angola, Bahrain, Botswana, Burundi, Egypt, Eritrea, Ethiopia, Ghana, Jordan, Kenya, Kuwait, Liberia, Malawi, Malta, Mozambique, Nigeria, Oman, Pakistan, Qatar, Rwanda, Sao Tome, Saudi Arabia, Sierra Leone, Somalia, Tanzania, Uganda, United Arab Emirates, the United Kingdom, West Bank/Gaza, Yemen, Zambia, and Zimbabwe;** and 5) "the laws of South Africa" in **South Africa, Namibia, Lesotho and Swaziland.**

Jurisdiction: *The following exceptions are added to this section:*

1) In **Austria** the choice of jurisdiction for all disputes arising out of this Statement of Limited Warranty and relating thereto, including its existence, will be the competent court of law in Vienna, Austria (Inner-City); 2) in **Angola, Bahrain, Botswana, Burundi, Egypt, Eritrea, Ethiopia, Ghana, Jordan, Kenya, Kuwait, Liberia, Malawi, Malta, Mozambique, Nigeria, Oman, Pakistan, Qatar, Rwanda, Sao Tome, Saudi Arabia, Sierra Leone, Somalia, Tanzania, Uganda, United Arab Emirates, West Bank/Gaza, Yemen, Zambia, and Zimbabwe** all disputes arising out of this Statement of Limited Warranty or related to its execution, including summary proceedings, will be submitted to the exclusive jurisdiction of the English courts; 3) in **Belgium and Luxembourg**, all disputes arising out of this Statement of Limited Warranty or related to its interpretation or its execution, the law, and the courts of the capital city, of the country of your registered office and/or commercial site location only are competent; 4) in **France, Algeria, Benin, Burkina Faso, Cameroon, Cape Verde, Central African Republic, Chad, Comoros, Congo Republic, Djibouti, Democratic Republic of Congo, Equatorial Guinea, French Guiana, French Polynesia, Gabon, Gambia, Guinea, Guinea-Bissau, Ivory Coast, Lebanon, Madagascar, Mali, Mauritania, Mauritius, Mayotte, Morocco, New Caledonia, Niger, Reunion, Senegal, Seychelles, Togo, Tunisia, Vanuatu, and Wallis & Futuna** all disputes arising out of this Statement of Limited Warranty or related to its violation or execution, including summary proceedings, will be settled exclusively by the Commercial Court of Paris; 5) in **Russia**, all disputes arising out of or in relation to the interpretation, the violation, the termination, the

nullity of the execution of this Statement of Limited Warranty shall be settled by Arbitration Court of Moscow; 6) **in South Africa, Namibia, Lesotho and Swaziland**, both of us agree to submit all disputes relating to this Statement of Limited Warranty to the jurisdiction of the High Court in Johannesburg; 7) **in Turkey** all disputes arising out of or in connection with this Statement of Limited Warranty shall be resolved by the Istanbul Central (Sultanahmet) Courts and Execution Directorates of Istanbul, the Republic of Turkey; 8) in each of the following specified countries, any legal claim arising out of this Statement of Limited Warranty will be brought before, and settled exclusively by, the competent court of a) Athens for **Greece**, b) Tel Aviv-Jaffa for **Israel**, c) Milan for **Italy**, d) Lisbon for **Portugal**, and e) Madrid for **Spain**; and 9) **in the United Kingdom**, both of us agree to submit all disputes relating to this Statement of Limited Warranty to the jurisdiction of the English courts.

Arbitration: *The following is added under this heading:*

In Albania, Armenia, Azerbaijan, Belarus, Bosnia-Herzegovina, Bulgaria, Croatia, Georgia, Hungary, Kazakhstan, Kyrgyzstan, FYR Macedonia, Moldova, Poland, Romania, Russia, Slovakia, Slovenia, Tajikistan, Turkmenistan, Ukraine, Uzbekistan, and FR Yugoslavia all disputes arising out of this Statement of Limited Warranty or related to its violation, termination or nullity will be finally settled under the Rules of Arbitration and Conciliation of the International Arbitral Center of the Federal Economic Chamber in Vienna (Vienna Rules) by three arbitrators appointed in accordance with these rules. The arbitration will be held in Vienna, Austria, and the official language of the proceedings will be English. The decision of the arbitrators will be final and binding upon both parties. Therefore, pursuant to paragraph 598 (2) of the Austrian Code of Civil Procedure, the parties expressly waive the application of paragraph 595 (1) figure 7 of the Code. IBM may, however, institute proceedings in a competent court in the country of installation.

In Estonia, Latvia and Lithuania all disputes arising in connection with this Statement of Limited Warranty will be finally settled in arbitration that will be held in Helsinki, Finland in accordance with the arbitration laws of Finland then in effect. Each party will appoint one arbitrator. The arbitrators will then jointly appoint the chairman. If arbitrators cannot agree on the chairman, then the Central Chamber of Commerce in Helsinki will appoint the chairman.

EUROPEAN UNION (EU)

THE FOLLOWING TERMS APPLY TO ALL EU COUNTRIES:

Consumers have legal rights under applicable national legislation governing the sale of consumer goods. Such rights are not affected by the warranties provided in this Statement of Limited Warranty.

How to Obtain Warranty Service: *The following is added to this section:*

To obtain warranty service from IBM in EU countries, see the telephone listing in Part 3 - Warranty Information.

You may contact IBM at the following address:

IBM Warranty & Service Quality Dept.

PO Box 30

Spango Valley

Greenock

Scotland PA 16 OAH

**AUSTRIA, DENMARK, FINLAND, GREECE, ITALY, NETHERLANDS,
PORTUGAL, SPAIN, SWEDEN AND SWITZERLAND**

Limitation of Liability: *The following replaces the terms of this section in its entirety:*

Except as otherwise provided by mandatory law:

1. IBM's liability for any damages and losses that may arise as a consequence of the fulfillment of its obligations under or in connection with this Statement of Limited Warranty or due to any other cause related to this Statement of Limited Warranty is limited to the compensation of only those damages and losses proved and actually arising as an immediate and direct consequence of the non-fulfillment of such obligations (if IBM is at fault) or of such cause, for a maximum amount equal to the charges you paid for the Machine. For purposes of this item, the term "Machine" includes Machine Code and Licensed Internal Code ("LIC").

The above limitation shall not apply to damages for bodily injuries (including death) and damages to real property and tangible personal property for which IBM is legally liable.

2. **UNDER NO CIRCUMSTANCES IS IBM, ITS SUPPLIERS OR RESELLERS LIABLE FOR ANY OF THE FOLLOWING, EVEN IF INFORMED OF THEIR POSSIBILITY: 1) LOSS OF, OR DAMAGE TO, DATA; 2) INCIDENTAL OR INDIRECT DAMAGES, OR FOR ANY ECONOMIC CONSEQUENTIAL DAMAGES; 3) LOST PROFITS, EVEN IF THEY ARISE AS AN IMMEDIATE CONSEQUENCE OF THE EVENT THAT GENERATED THE DAMAGES; OR 4) LOSS OF BUSINESS, REVENUE, GOODWILL, OR ANTICIPATED SAVINGS.**

FRANCE AND BELGIUM

Limitation of Liability: *The following replaces the terms of this section in its entirety:*

Except as otherwise provided by mandatory law:

1. IBM's liability for any damages and losses that may arise as a consequence of the fulfillment of its obligations under or in connection with this Statement of Limited Warranty is limited to the compensation of only those damages and losses proved and actually arising as an immediate and direct consequence of the non-fulfillment of such obligations (if IBM is at fault), for a maximum amount equal to the charges you paid for the Machine that has caused the damages. For purposes of this item, the term "Machine" includes Machine Code and Licensed Internal Code ("LIC").

The above limitation shall not apply to damages for bodily injuries (including death) and damages to real property and tangible personal property for which IBM is legally liable.

2. **UNDER NO CIRCUMSTANCES IS IBM, ITS SUPPLIERS OR RESELLERS LIABLE FOR ANY OF THE FOLLOWING, EVEN IF INFORMED OF THEIR POSSIBILITY: 1) LOSS OF, OR DAMAGE TO, DATA; 2) INCIDENTAL OR INDIRECT DAMAGES, OR FOR ANY ECONOMIC CONSEQUENTIAL DAMAGES; 3) LOST PROFITS, EVEN IF THEY ARISE AS AN IMMEDIATE**

CONSEQUENCE OF THE EVENT THAT GENERATED THE DAMAGES;
OR 4) LOSS OF BUSINESS, REVENUE, GOODWILL, OR ANTICIPATED
SAVINGS.

THE FOLLOWING TERMS APPLY TO THE COUNTRY SPECIFIED:

AUSTRIA

What this Warranty Covers: *The following replaces the first sentence of the first paragraph of this section:*

The warranty for an IBM Machine covers the functionality of the Machine for its normal use and the Machine's conformity to its Specifications.

The following paragraphs are added to this Section:

The minimum warranty period for Machines is 12 months from the date of delivery. . The limitation period for consumers in action for breach of warranty is the statutory period as a minimum. In case IBM or your reseller is unable to repair an IBM Machine, you can alternatively ask for a partial refund as far as justified by the reduced value of the unrepaired Machine or ask for a cancellation of the respective agreement for such Machine and get your money refunded.

The second paragraph does not apply.

What IBM Will Do to Correct Problems: *The following is added to this section:*

During the warranty period, transportation for delivery of the failing Machine to IBM will be at IBM's expense.

Limitation of Liability: *The following paragraph is added to this section:*

The limitations and exclusions specified in the Statement of Limited Warranty will not apply to damages caused by IBM with fraud or gross negligence and for express warranty.

The following sentence is added to the end of item 2:

IBM's liability under this item is limited to the violation of essential contractual terms in cases of ordinary negligence.

EGYPT

Limitation of Liability: *The following replaces item 2 in this section:*

as to any other actual direct damages, IBM's liability will be limited to the total amount you paid for the Machine that is the subject of the claim. For purposes of this item, the term "Machine" includes Machine Code and Licensed Internal Code (LIC).

Applicability of suppliers and resellers (unchanged).

FRANCE

Limitation of Liability: *The following replaces the second sentence of the first paragraph of this section:*

In such instances, regardless of the basis on which you are entitled to claim damages from IBM, IBM is liable for no more than: *(items 1 and 2 unchanged).*

GERMANY

What this Warranty Covers: *The following replaces the first sentence of the first paragraph of this section:*

The warranty for an IBM Machine covers the functionality of the Machine for its normal use and the Machine's conformity to its Specifications.

The following paragraphs are added to this section:

The minimum warranty period for Machines is twelve months. In case IBM or your reseller is unable to repair an IBM Machine, you can alternatively ask for a partial refund as far as justified by the reduced value of the unrepaired Machine or ask for a cancellation of the respective agreement for such Machine and get your money refunded.

The second paragraph does not apply.

What IBM Will Do to Correct Problems: *The following is added to this section:*

During the warranty period, transportation for delivery of the failing Machine to IBM will be at IBM's expense.

Limitation of Liability: *The following paragraph is added to this section:*

The limitations and exclusions specified in the Statement of Limited Warranty will not apply to damages caused by IBM with fraud or gross negligence and for express warranty.

The following sentence is added to the end of item 2:

IBM's liability under this item is limited to the violation of essential contractual terms in cases of ordinary negligence.

HUNGARY

Limitation of Liability: *The following is added at the end of this section:*

The limitation and exclusion specified herein shall not apply to liability for a breach of contract damaging life, physical well-being, or health that has been caused intentionally, by gross negligence, or by a criminal act.

The parties accept the limitations of liability as valid provisions and state that the Section 314.(2) of the Hungarian Civil Code applies as the acquisition price as well as other advantages arising out of the present Statement of Limited Warranty balance this limitation of liability.

IRELAND

What this Warranty Covers: *The following is added to this section:*

Except as expressly provided in these terms and conditions, all statutory conditions, including all warranties implied, but without prejudice to the generality of the foregoing all warranties implied by the Sale of Goods Act 1893 or the Sale of Goods and Supply of Services Act 1980 are hereby excluded.

Limitation of Liability: *The following replaces the terms of this section in its entirety:*

For the purposes of this section, a "Default" means any act, statement, omission, or negligence on the part of IBM in connection with, or in relation to, the subject matter of this Statement of Limited Warranty in respect of which IBM is legally liable to you, whether in contract or tort. A number of Defaults which together result in, or contribute to, substantially the same loss or damage will be treated as one Default occurring on the date of occurrence of the last such Default.

Circumstances may arise where, because of a Default, you are entitled to recover damages from IBM.

This section sets out the extent of IBM's liability and your sole remedy.

1. IBM will accept unlimited liability for death or personal injury caused by the negligence of IBM.
2. Subject always to the Items for Which IBM is Not Liable below, IBM will accept unlimited liability for physical damage to your tangible property resulting from the negligence of IBM.
3. Except as provided in items 1 and 2 above, IBM's entire liability for actual damages for any one Default will not in any event exceed the greater of 1) EUR 125,000, or 2) 125% of the amount you paid for the Machine directly relating to the Default.

Items for Which IBM is Not Liable

Save with respect to any liability referred to in item 1 above, under no circumstances is IBM, its suppliers or resellers liable for any of the following, even if IBM or they were informed of the possibility of such losses:

1. loss of, or damage to, data;
2. special, indirect, or consequential loss; or
3. loss of profits, business, revenue, goodwill, or anticipated savings.

SLOVAKIA

Limitation of Liability: *The following is added to the end of the last paragraph:*

The limitations apply to the extent they are not prohibited under §§ 373-386 of the Slovak Commercial Code.

SOUTH AFRICA, NAMIBIA, BOTSWANA, LESOTHO AND SWAZILAND

Limitation of Liability: *The following is added to this section:*

IBM's entire liability to you for actual damages arising in all situations involving nonperformance by IBM in respect of the subject matter of this Statement of Warranty will be limited to the charge paid by you for the individual Machine that is the subject of your claim from IBM.

UNITED KINGDOM

Limitation of Liability: *The following replaces the terms of this section in its entirety:*

For the purposes of this section, a "Default" means any act, statement, omission, or negligence on the part of IBM in connection with, or in relation to, the subject matter of this Statement of Limited Warranty in respect of which IBM is legally

liable to you, whether in contract or tort. A number of Defaults which together result in, or contribute to, substantially the same loss or damage will be treated as one Default.

Circumstances may arise where, because of a Default, you are entitled to recover damages from IBM.

This section sets out the extent of IBM's liability and your sole remedy.

1. IBM will accept unlimited liability for:
 - a. death or personal injury caused by the negligence of IBM; and
 - b. any breach of its obligations implied by Section 12 of the Sale of Goods Act 1979 or Section 2 of the Supply of Goods and Services Act 1982, or any statutory modification or re-enactment of either such Section.
2. IBM will accept unlimited liability, subject always to the Items for Which IBM is Not Liable below, for physical damage to your tangible property resulting from the negligence of IBM.
3. IBM's entire liability for actual damages for any one Default will not in any event, except as provided in items 1 and 2 above, exceed the greater of 1) Pounds Sterling 75,000, or 2) 125% of the total purchase price payable or the charges for the Machine directly relating to the Default.

These limits also apply to IBM's suppliers and resellers. They state the maximum for which IBM and such suppliers and resellers are collectively responsible.

Items for Which IBM is Not Liable

Save with respect to any liability referred to in item 1 above, under no circumstances is IBM or any of its suppliers or resellers liable for any of the following, even if IBM or they were informed of the possibility of such losses:

1. loss of, or damage to, data;
2. special, indirect, or consequential loss; or
3. loss of profits, business, revenue, goodwill, or anticipated savings.

Part 3 - Warranty Information

This Part 3 provides information regarding the warranty applicable to your Machine, including the warranty period and type of warranty service IBM provides.

Warranty Period

The warranty period may vary by country or region and is specified in the table below. NOTE: "Region" means either Hong Kong or Macau Special Administrative Region of China.

IBM USB 2.0 CD-RW/DVD-ROM Combo Drive

Country or Region of Purchase	Warranty Period	Type of Warranty Service
Worldwide	1 year	1, 4

A warranty period of 1 year on parts and 1 year on labor means that IBM provides warranty service without charge for parts and labor during the 1 year warranty period.

Types of Warranty Service

If required, IBM provides repair or exchange service depending on the type of warranty service specified for your Machine in the above table and as described below. Warranty service may be provided by your reseller if approved by IBM to perform warranty service. Scheduling of service will depend upon the time of your call and is subject to parts availability. Service levels are response time objectives and are not guaranteed. The specified level of warranty service may not be available in all worldwide locations, additional charges may apply outside IBM's normal service area, contact your local IBM representative or your reseller for country and location specific information.

1. Customer Replaceable Unit ("CRU") Service

IBM will ship CRU parts to you for your replacement. If IBM instructs you to return the replaced CRU, you are responsible for returning it to IBM in accordance with IBM's instructions. If you do not return the defective CRU, if IBM so instructs, within 30 days of your receipt of the replacement CRU, IBM may charge you for the replacement.

2. On-site Service

IBM or your reseller will either repair or exchange the failing Machine at your location and verify its operation. You must provide suitable working area to allow disassembly and reassembly of the IBM Machine. The area must be clean, well lit and suitable for the purpose. **For some Machines, certain repairs may require sending the Machine to an IBM service center.**

3. Courier or Depot Service¹

You will disconnect the failing Machine for collection arranged by IBM. IBM will provide you with a shipping container for you to return your Machine to a designated service center. A courier will pick up your Machine and deliver it to the designated service center. Following its repair or exchange, IBM will arrange the return delivery of the Machine to your location. You are responsible for its installation and verification.

4. Customer Carry-In or Mail-In Service

You will deliver or mail as IBM specifies (prepaid unless IBM specifies otherwise) the failing Machine suitably packaged to a location IBM designates. After IBM has repaired or exchanged the Machine, IBM will make it available for your collection or, for Mail-in Service, IBM will return it to you at IBM's expense, unless IBM specifies otherwise. You are responsible for the subsequent installation and verification of the Machine.

The IBM Machine Warranty worldwide web site at http://www.ibm.com/servers/support/machine_warranties/ provides a worldwide overview of IBM's Limited Warranty for Machines, a Glossary of IBM

1. This type of service is called ThinkPad EasyServ or EasyServ in some countries.

definitions, Frequently Asked Questions (FAQs) and Support by Product (Machine) with links to Product Support pages. **The IBM Statement of Limited Warranty is also available on this site in 29 languages.**

To obtain warranty service contact IBM or your IBM reseller. In Canada or the United States, call 1-800-IBM-SERV (426-7378). For other countries, see the telephone numbers below.

Phone numbers are subject to change without notice. For the latest phone number list, go to <http://www.ibm.com/pc/support> and click **Support Phone List**.

Country or Region	Telephone Number	Country or Region	Telephone Number
Argentina	0800-666-0011	Malaysia	03-7727-7800
Australia	1300-130-426	Mexico	001-866-434-2080
Austria	01-24592-5901	Netherlands	020-514-5770
Belgium	Dutch 02-210-9820 French 02-210-9800	New Zealand	0800-446-149
Bolivia	0800-0189	Norway	66 81 11 00
Brazil	55-11-3889-8986	Peru	0-800-50-866
Canada	1-800-565-3344 Toronto 416-383-3344	Philippines	632-995-2225
Chile	800-224-488	Portugal	21-791 51 47
China (PRC)	800-810-1818	Russia	095-940-2000
China (Hong Kong S.A.R.)	852-2825-7799	Singapore	1800-840-9911
Columbia	980-912-3021	Spain	91-662 49 16
Denmark	45 20 82 00	Sweden	08-477 4420
Ecuador	1-800-426911 (option #4)	Switzerland	058-333-09-00
Finland	09-459 69 60	Taiwan	886-2-2725-9799
France	02 38 55 74 50	Thailand	66-2-273-4000
Germany	07032-1549 201	Turkey	00-800-446-32-041
Indonesia	021-523-8535	United Kingdom	0-1475-555 055
Ireland	01-815-9202	United States	1-800-426-7378
Italy	02-7031-6101	Uruguay	000-411-005-6649
Japan	Consumer customers 0120-887-870 Business customers 0120-887-874	Venezuela	0-800-100-2011
Luxembourg	298-977 5063	Vietnam	848-8295-160

Appendix D. Notices

IBM may not offer the products, services, or features discussed in this document in all countries. Consult your local IBM representative for information on the products and services currently available in your area. Any reference to an IBM product, program, or service is not intended to state or imply that only that IBM product, program, or service may be used. Any functionally equivalent product, program, or service that does not infringe any IBM intellectual property right may be used instead. However, it is the user's responsibility to evaluate and verify the operation of any non-IBM product, program, or service.

IBM may have patents or pending patent applications covering subject matter described in this document. The furnishing of this document does not give you any license to these patents. You can send license inquiries, in writing, to:

*IBM Director of Licensing
IBM Corporation
North Castle Drive
Armonk, NY 10504-1785
U.S.A.*

INTERNATIONAL BUSINESS MACHINES CORPORATION PROVIDES THIS PUBLICATION "AS IS" WITHOUT WARRANTY OF ANY KIND, EITHER EXPRESS OR IMPLIED, INCLUDING, BUT NOT LIMITED TO, THE IMPLIED WARRANTIES OF NON-INFRINGEMENT, MERCHANTABILITY OR FITNESS FOR A PARTICULAR PURPOSE. Some jurisdictions do not allow disclaimer of express or implied warranties in certain transactions, therefore, this statement may not apply to you.

This information could include technical inaccuracies or typographical errors. Changes are periodically made to the information herein; these changes will be incorporated in new editions of the publication. IBM may make improvements and/or changes in the product(s) and/or the program(s) described in this publication at any time without notice.

The products described in this document are not intended for use in implantation or other life support applications where malfunction may result in injury or death to persons. The information contained in this document does not affect or change IBM product specifications or warranties. Nothing in this document shall operate as an express or implied license or indemnity under the intellectual property rights of IBM or third parties. All information contained in this document was obtained in specific environments and is presented as an illustration. The result obtained in other operating environments may vary.

IBM may use or distribute any of the information you supply in any way it believes appropriate without incurring any obligation to you.

Any references in this publication to non-IBM Web sites are provided for convenience only and do not in any manner serve as an endorsement of those Web sites. The materials at those Web sites are not part of the materials for this IBM product, and use of those Web sites is at your own risk.

Any performance data contained herein was determined in a controlled environment. Therefore, the result obtained in other operating environments may

vary significantly. Some measurements may have been made on development-level systems and there is no guarantee that these measurements will be the same on generally available systems. Furthermore, some measurements may have been estimated through extrapolation. Actual results may vary. Users of this document should verify the applicable data for their specific environment.

Trademarks

The following terms are trademarks of International Business Machines Corporation in the United States, other countries, or both:

IBM
IBM logo
OS/2
ThinkPad

Microsoft and Windows are trademarks of Microsoft Corporation in the United States, other countries, or both.

Other company, product, or service names may be trademarks or service marks of others.

Electronic emission notices

IBM USB 2.0 CD-RW/DVD-ROM Combo Drive

Federal Communications Commission (FCC) statement

Note: This equipment has been tested and found to comply with the limits for a Class B digital device, pursuant to Part 15 of the FCC Rules. These limits are designed to provide reasonable protection against harmful interference in a residential installation. This equipment generates, uses, and can radiate radio frequency energy and, if not installed and used in accordance with the instructions, may cause harmful interference to radio communications. However, there is no guarantee that interference will not occur in a particular installation. If this equipment does cause harmful interference to radio or television reception, which can be determined by turning the equipment off and on, the user is encouraged to try to correct the interference by one or more of the following measures:

- Reorient or relocate the receiving antenna.
- Increase the separation between the equipment and receiver.
- Connect the equipment into an outlet on a circuit different from that to which the receiver is connected.
- Consult an IBM authorized dealer or service representative for help.

Properly shielded and grounded cables and connectors must be used in order to meet FCC emission limits. Proper cables and connectors are available from IBM authorized dealers. IBM is not responsible for any radio or television interference caused by using other than recommended cables and connectors or by unauthorized changes or modifications to this equipment. Unauthorized changes or modifications could void the user's authority to operate the equipment.

This device complies with Part 15 of the FCC Rules. Operation is subject to the following two conditions: (1) this device may not cause harmful interference, and (2) this device must accept any interference received, including interference that may cause undesired operation.

Responsible party:
International Business Machines Corporation
New Orchard Road
Armonk, NY 10504
Telephone: 1-919-543-2193

 Tested To Comply
With FCC Standards
FOR HOME OR OFFICE USE

Industry Canada Class B emission compliance statement

This Class B digital apparatus complies with Canadian ICES-003.

Avis de conformité a la réglementation d'Industrie Canada

Cet appareil numérique de la classe B est conforme à la norme NMB-003 du Canada.

Deutsche EMV-Direktive (electromagnetische Verträglichkeit)

Zulassungbescheinigung laut dem Deutschen Gesetz über die elektromagnetische Verträglichkeit von Geräten (EMVG) vom 30. August 1995 (bzw. der EMC EG Richtlinie 89/336):

Dieses Gerät ist berechtigt in Übereinstimmung mit dem Deutschen EMVG das EG-Konformitätszeichen - CE - zu führen. Verantwortlich für die Konformitätserklärung nach Paragraph 5 des EMVG ist die:

IBM Deutschland Informationssysteme GmbH, 70548 Stuttgart.

Informationen in Hinsicht EMVG Paragraph 3 Abs. (2) 2:

Das Gerät erfüllt die Schutzanforderungen nach EN 55024:1998 und EN 55022:1998 Klasse B.
--

EN 55022 Hinweis:

“Wird dieses Gerät in einer industriellen Umgebung betrieben (wie in EN 55022:B festgelegt), dann kann es dabei eventuell gestört werden. In solch einem FA11 ist der Abstand bzw. die Abschirmung zu der industriellen Störquelle zu vergrößern.”

Anmerkung:

Um die Einhaltung des EMVG sicherzustellen sind die Geräte, wie in den IBM Handbüchern angegeben, zu installieren und zu betreiben.

European Union - emission directive

This product is in conformity with the protection requirements of EU Council Directive 89/336/ECC on the approximation of the laws of the Member States relating to electromagnetic compatibility.

IBM can not accept responsibility for any failure to satisfy the protection requirements resulting from a non-recommended modification of the product, including the fitting of non-IBM option cards.

This product has been tested and found to comply with the limits for Class B Information Technology Equipment according to European Standard EN 55022. The limits for Class B equipment were derived for typical residential environments to provide reasonable protection against interference with licensed communication devices.

Union Européenne - Directive Conformité électromagnétique

Ce produit est conforme aux exigences de protection de la Directive 89/336/EEC du Conseil de l'UE sur le rapprochement des lois des États membres en matière de compatibilité électromagnétique.

IBM ne peut accepter aucune responsabilité pour le manquement aux exigences de protection résultant d'une modification non recommandée du produit, y compris l'installation de cartes autres que les cartes IBM.

Ce produit a été testé et il satisfait les conditions de l'équipement informatique de Classe B en vertu de Standard européen EN 55022. Les conditions pour l'équipement de Classe B ont été définies en fonction d'un contexte résidentiel ordinaire afin de fournir une protection raisonnable contre l'interférence d'appareils de communication autorisés.

Unione Europea - Directiva EMC (Conformidad electromagnética)

Este producto satisface los requisitos de protección del Consejo de la UE, Directiva 89/336/CEE en lo que a la legislatura de los Estados Miembros sobre compatibilidad electromagnética se refiere.

IBM no puede aceptar responsabilidad alguna si este producto deja de satisfacer dichos requisitos de protección como resultado de una modificación no recomendada del producto, incluyendo el ajuste de tarjetas de opción que no sean IBM.

Este producto ha sido probado y satisface los límites para Equipos Informáticos Clase B de conformidad con el Estándar Europeo EN 55022. Los límites para los equipos de Clase B se han establecido para entornos residenciales típicos a fin de proporcionar una protección razonable contra las interferencias con dispositivos de comunicación licenciados.

Unione Europea - Normativa EMC

Questo prodotto è conforme alle normative di protezione ai sensi della Direttiva del Consiglio dell'Unione Europea 89/336/CEE sull'armonizzazione legislativa degli stati membri in materia di compatibilità elettromagnetica.

IBM non accetta responsabilità alcuna per la mancata conformità alle normative di protezione dovuta a modifiche non consigliate al prodotto, compresa l'installazione di schede e componenti di marca diversa da IBM.

Le prove effettuate sul presente prodotto hanno accertato che esso rientra nei limiti stabiliti per le apparecchiature di informatica Classe B ai sensi della Norma Europea EN 55022. I limiti delle apparecchiature della Classe B sono stati stabiliti

al fine di fornire ragionevole protezione da interferenze mediante dispositivi di comunicazione in concessione in ambienti residenziali tipici.

이 기기는 가정용으로 전자파 적합등록을 한 기기로서
주거지역에서는 물론 모든 지역에서 사용할 수 있습니다.

この装置は、情報処理装置等電波障害自主規制協議会（VCCI）の基準に基づくクラスB情報技術装置です。この装置は、家庭環境で使用することを目的としていますが、この装置がラジオやテレビジョン受信機に近接して使用されると、受信障害を引き起こすことがあります。
取扱説明書に従って正しい取り扱いをして下さい。

Japanese statement of compliance for products less than or equal to 20 A per phase

高調波ガイドライン適合品



Part Number: 22P9218

Printed in USA

(1P) P/N: 22P9218

