

NetVista™

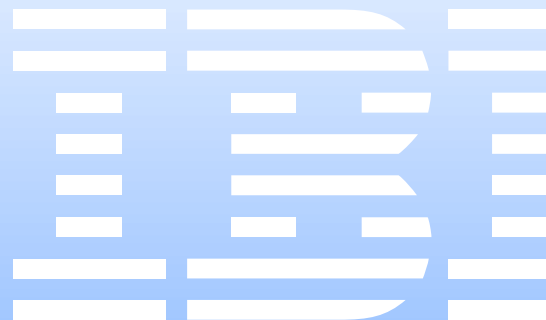

Technical Information Manual
A20 Type 6269
A40 Types 6568, 6578, 6648
A40p Types 6569, 6579, 6649



NetVista™



Technical Information Manual
A20 Type 6269
A40 Types 6568, 6578, 6648
A40p Types 6569, 6579, 6649

Note

Before using this information and the product it supports, be sure to read the information in Appendix E, "Notices and trademarks," on page 53.

First Edition (June 2000)

© COPYRIGHT INTERNATIONAL BUSINESS MACHINES CORPORATION, 2000. All rights reserved.

Note to U.S. Government Users — Documentation related to restricted rights — Use, duplication or disclosure is subject to restrictions set forth in GSA ADP Schedule Contract with IBM Corp.

IBM

Contents

Preface	vii
Chapter 1. System overview	1
Major features	1
Other features	2
Network support	2
Wake on LAN	2
Chapter 2. System board features	3
System board layout for the NetVista A40 and A40p computer	3
Riser card layout for the small form factor desktop model computer	4
System board layout for the A20 model computer	4
Microprocessor features	5
Pentium III microprocessor with MMX technology	5
Celeron microprocessor with MMX technology	5
Chip set control	6
Memory subsystem	6
PCI bus	7
IDE bus master interface	7
USB interface	7
Super I/O controller	8
Diskette drive interface	8
Serial ports	8
Parallel port	9
Keyboard and mouse ports	9
Low pin-count bus	9
Video subsystem	10
Features of the Intel 815E/810E integrated graphics subsystem	10
Features of the NVidia 4x AGP adapter	11
Monitor support	11
Audio subsystem	11
Network connection	12
Real-time clock and CMOS	12
Flash EEPROM	12
Expansion adapters	12
Cable connectors	13
Chapter 3. Physical specifications	17
Physical specifications — A40 and A40p small form factor desktop model	17
Physical specifications — A40 and A40p desktop model	18
Physical specifications — A20 desktop model	19
Chapter 4. Power supply	21
Power input	21
Power output	21
Component outputs	22
Output protection	22
Internal device connectors	23
Chapter 5. System software	25
BIOS	25
Plug and Play	25
POST	25
Configuration/Setup Utility program	26

Advanced Power Management (APM)	26
Advanced Configuration and Power Interface (ACPI)	26
Flash update utility program	26
Diagnostic program	26
Chapter 6. System compatibility	27
Hardware compatibility	27
Hardware interrupts	27
Hard disk drives and controller	28
Machine-sensitive programs	28
Appendix A. Connector-pin assignments	29
External connectors	29
Monitor connector	29
USB port connectors	29
Keyboard and mouse connectors	30
Serial connector	30
Parallel connector	31
Ethernet connector	31
MIDI/joystick connector	32
Internal connectors	32
Diskette drive connector	32
IDE connectors	33
Memory connectors	34
32-bit PCI connectors	37
32-bit PCI connector with integrated Ethernet extension	39
Power supply connectors	41
Wake on LAN connector	42
Tamper detection switch	42
RFID	42
CD audio connector	42
SCSI LED connectors	43
Appendix B. System address maps	45
System memory map	45
I/O address map	45
DMA I/O address map	47
Appendix C. IRQ and DMA channel assignments	49
Appendix D. Error codes	51
POST error codes	51
Beep codes	51
Appendix E. Notices and trademarks	53
Notices	53
Trademarks	54
Bibliography	55
Index	57

Preface

This *Technical Information Manual* provides information for the IBM® NetVista™ computer. The manual is intended for developers who want to provide hardware and software products to operate with this IBM computer. It provides an in-depth view of how this IBM computer works. Users of this publication should have an understanding of computer architecture and programming concepts.

Related publications

In addition to this manual, the following IBM publications provide information related to the operation of the IBM NetVista computer:

- *NetVista User Guide*
This publication, available on the hard disk and on the *Software Selections CD* if your computer came with preinstalled software, contains information about setting up your computer, configuring hardware and software, operating and maintaining your computer, and installing options. Also included are instructions for diagnosing and solving problems and information on how to obtain help and service.
- *Quick Reference*
This publication contains general information to help you to safely set up your computer and access important online publications.
- *Understanding Your Personal Computer*
This online document includes general information about using computers and information about the features of the NetVista computer. It is available at <http://www.ibm.com/pc/support> on the World Wide Web.
- *Hardware Maintenance Manual*
This publication contains information for trained service technicians. It is available at <http://www.ibm.com/pc/support> on the World Wide Web, and it can also be ordered from IBM. To purchase a copy, see the "Getting help, service, and information" section in the *NetVista User Guide*.

Terminology usage

Attention: The term *reserved* describes certain signals, bits, and registers that should not be changed. Use of reserved areas can cause compatibility problems, loss of data, or permanent damage to the hardware. When the contents of a register are changed, the state of the reserved bits must be preserved. When possible, read the register first and change only the bits that must be changed.

In this manual, some signals are represented in an all-capital-letter format (–ACK). A minus sign in front of the signal indicates that the signal is active low. No sign in front of the signal indicates that the signal is active high.

The use of the term hex indicates a hexadecimal number.

When numerical modifiers such as K, M, and G are used, they typically indicate powers of 2, not powers of 10. For example, 1 KB equals 1 024 bytes (2^{10}), and 1 GB equals 1 073 741 824 bytes (2^{30}). However, when expressing storage capacity, powers of 10 are used. 1 MB equals approximately 1 000 KB (1 000 000 bytes).

Note: Depending on the operating system and other system requirements, the storage capacity available to the user might vary.

Chapter 1. System overview

NetVista computer systems provide state-of-the-art computing power with room for future growth.

Major features

The major features are:

- An Intel® Pentium® III microprocessor with MMX™ technology, streaming single-instruction multiple data (SIMD) extensions and 256 KB advanced transfer cache memory or Celeron® microprocessor with MMX technology, SIMD extensions and 128 KB advanced transfer cache
- Up to 512 Megabytes (MB) of system memory
- Integrated drive electronics (IDE) bus master controller, Ultra DMA-66 capable (some models Ultra DMA-100 capable)
- System management
 - Wake on LAN® support
 - Desktop Management Interface (DMI) basic input/output system (BIOS) and DMI software
 - Integrated network protocols
 - Enablement for Remote Administration
- IDE CD-ROM drive (some models)
- Asset security
 - Security settings provided by the Configuration/Setup Utility program
 - Power-on and administrator password protection
 - Startup sequence control
 - Hard disk drive and diskette drive access control
 - Input/output (I/O) port control
 - Cover key lock (some models)
 - U-bolt and security cabling capable
 - Operating system security
 - Tamper-detection switch on the chassis (some models)
- Accelerated graphics port (AGP) adapter (available on some models only)
- Integrated 16-bit stereo audio controller and built-in high-quality speaker (supports SoundBlaster, Adlib, and Microsoft® Windows® Sound System applications) (some models only)
- IBM 10/100 megabits-per-second (Mbps) Ethernet subsystem with Wake on LAN support (on some models)
- Expansion

- Drive bays
 - Small form factor desktop model: three drive bays
 - Desktop model: four drive bays
- Adapter slots
 - Small form factor desktop model: two peripheral component interconnect (PCI) expansion slots
 - Desktop model: three PCI expansion slots and one AGP slot (some models)
- PCI version 2.2 I/O bus compatibility
- 3.5-inch, 1.44 MB diskette drive
- Input/Output features
 - One 25-pin parallel port with Extended Capabilities Port (ECP)/Extended Parallel Port (EPP) support
 - One (A20) or two (A40) 9-pin universal asynchronous receiver/transmitter (UART) serial ports
 - Two 4-pin Universal Serial Bus (USB) ports
 - One 6-pin keyboard port
 - One 6-pin mouse port
 - One 15-pin DD2CB-compliant monitor port
 - Three 3.5-mm audio jacks (line out/headphone, line-in, microphone)
 - One nine-pin MIDI/joystick connector (A20 models only)

Other features

The NetVista computer supports the following features.

Network support

The NetVista computer is enabled to support the addition of options to perform management over a network. The following is a list of supported functions:

- Selectable primary startup sequence
- Selectable automatic power-on startup sequence
- Selectable error startup sequence
- Power-on self-test (POST)/BIOS update from network
- Wake on LAN
- Complimentary metal oxide semiconductor (CMOS) Save/Restore utility program
- CMOS setup over LAN
- Wake on Ring (if Wake on Ring supported modem is installed)

Wake on LAN

The power supply of the computer supports the Wake on LAN feature. You can use the Wake on LAN feature to turn on the computer by passing a specific LAN frame to the computer over the LAN. You can find the menu for setting the Wake on LAN feature in the Configuration/Setup Utility program. For more information, see the *NetVista User Guide*.

Chapter 2. System board features

This section includes information about system board features.

System board layout for the NetVista A40 and A40p computer

The system board might look slightly different from the one shown.

Note: A diagram of the system board, including switch and jumper settings, is attached to the computer cover.

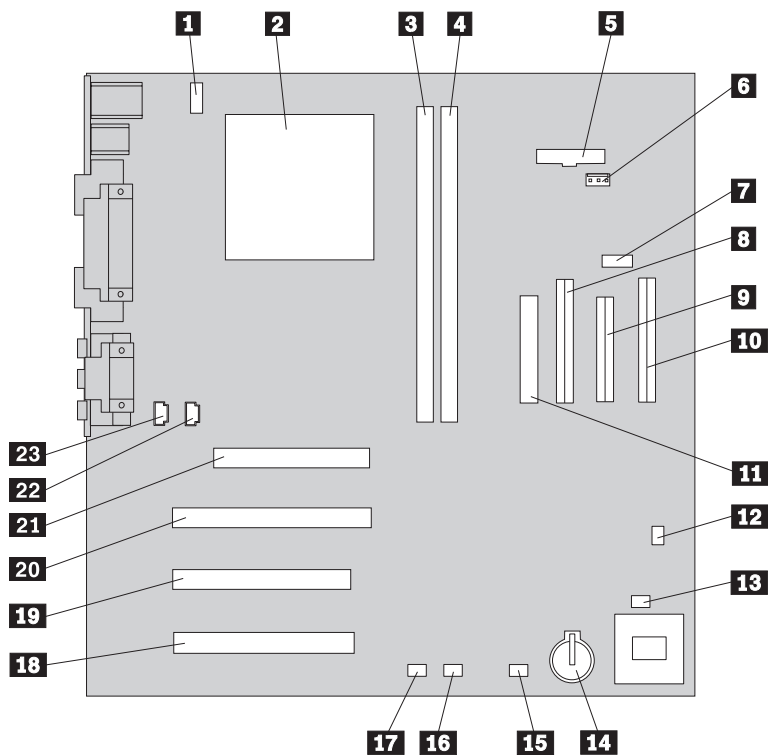

- | | | | |
|-----------|----------------------------|-----------|----------------------------|
| 1 | Fan connector 2 | 13 | Fan connector 1 |
| 2 | Microprocessor | 14 | Battery |
| 3 | DIMM 1 | 15 | SCSI adapter LED connector |
| 4 | DIMM 2 | 16 | Alert on LAN connector |
| 5 | Power LED connector | 17 | Wake on LAN connector |
| 6 | RFID connector | 18 | PCI slot 3 |
| 7 | Front USB connector | 19 | PCI slot 2 |
| 8 | Secondary IDE connector | 20 | PCI slot 1 |
| 9 | Diskette drive connector | 21 | AGP slot |
| 10 | Primary IDE connector | 22 | CD-ROM audio connector |
| 11 | Power supply connector | 23 | Speaker connector |
| 12 | Clear CMOS/recovery jumper | | |

Riser card layout for the small form factor desktop model computer

The riser card might look slightly different from the one shown.

Note: A diagram of the system board, including switch and jumper settings, is attached to the computer cover.

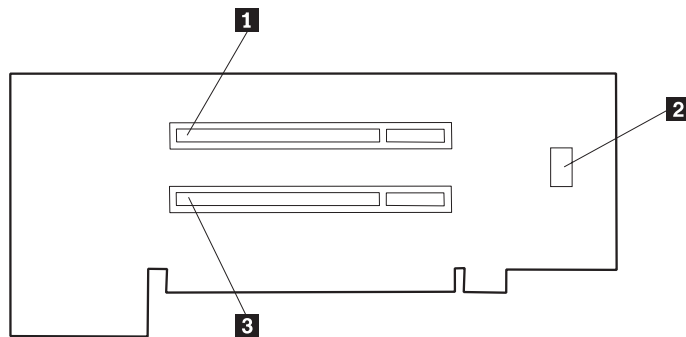

- 1** PCI connector 1
- 2** Ethernet disable jumper
- 3** PCI connector 2

System board layout for the A20 model computer

The system board might look slightly different from the one shown.

Note: A diagram of the system board, including switch and jumper settings, is attached to the computer cover.

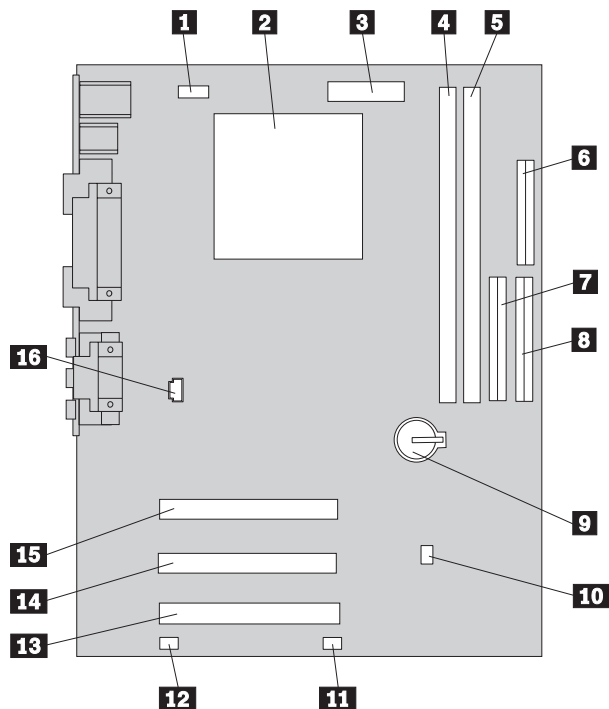

1	CPU fan connector	9	Battery
2	Microprocessor	10	Clear CMOS/recovery jumper
3	Power connector	11	Front fan connector
4	DIMM 1	12	Wake on LAN connector
5	DIMM 2	13	PCI slot 3
6	Diskette drive connector	14	PCI slot 2
7	Secondary IDE connector	15	PCI slot 1
8	Primary IDE connector	16	CD-ROM audio connector

Microprocessor features

The NetVista computer comes with an Intel Pentium III or Celeron microprocessor. The microprocessor, which has an attached heat sink, plugs directly into a connector on the system board.

Pentium III microprocessor with MMX technology

The features of the microprocessor are as follows:

- Optimization for 32-bit software
- 64-bit microprocessor data bus
- 100 MHz or 133 MHz front-side bus (FSB)
- 256 KB full-speed advanced transfer cache memory integrated into the microprocessor
 - 4-way set associative
 - Nonblocking
- 36-bit microprocessor address bus
- Math coprocessor
- MMX technology, which boosts the processing of graphic, video, and audio data

Celeron microprocessor with MMX technology

The features of the microprocessor are as follows:

- Optimization for 32-bit software
- 64-bit microprocessor data bus
- 66 MHz FSB
- 128 KB full-speed advanced transfer cache memory integrated into the microprocessor
 - 4-way set associative
 - Nonblocking
- 36-bit microprocessor address bus
- Math coprocessor
- MMX technology, which boosts the processing of graphic, video, and audio data

Chip set control

A40 and A40p models use the Intel 815E chip set. The Intel 815E chip set is the interface between the microprocessor and the following:

- Memory subsystem
- PCI buses
- IDE bus master connection
- USB ports
- System Management Bus (SMBus)
- Enhanced DMA controller
- Real-time clock (RTC)
- Ethernet
- Audio

A20 models use the Intel 810E chip set. The Intel 810E chip set is the interface between the microprocessor and the following:

- Memory subsystem
- PCI buses
- IDE bus master connection
- USB ports
- SMBus
- Enhanced DMA controller
- Real-time clock (RTC)
- Audio
- MIDI/joystick port
- Video

Memory subsystem

The system memory interface is controlled by the Intel 815E chip set (A20 by the 810E chip set). System memory is synchronous dynamic random access memory (SDRAM).

The maximum amount of system memory is 512 MB. For memory expansion, the system board provides dual inline memory module (DIMM) connectors.

The system board supports PC100 and PC133 memory DIMMs (A20 supports PC133 only) in sizes of 64 MB, 128 MB, and 256 MB. The amount of preinstalled memory varies by model.

The following information applies to system memory:

- Non-error checking and correction (non-ECC) SDRAM is supported.
- The maximum height of memory modules is 3.465 cm (1.375 in.).
- Use PC100 or PC133 DIMMs only.
- System memory is auto-detected and auto-configured using serial presence detect.

For information on the pin assignments for the memory module connectors, see "Memory connectors" on page 34.

PCI bus

The fully synchronous 32-bit 33 MHz PCI bus originates in the chip set. Features of these PCI buses are:

- Integrated arbiter with multitransaction, PCI-arbitration, acceleration hooks
- Zero-wait-state, microprocessor-to-PCI write interface for high-performance graphics
- Built-in PCI bus arbiter with support for all PCI devices and connectors
- Microprocessor-to-PCI memory write posting
- Conversion of back-to-back, sequential, microprocessor-to-PCI memory write to PCI burst write
- PCI-to-DRAM memory up to 528 megabytes per second (MBps) speed
- PCI 2.2 compliant
- Delayed transaction
- PCI parity checking and generation support

IDE bus master interface

The system board incorporates a PCI-to-IDE interface that complies with the *AT Attachment Interface with Extensions* standard.

The bus master for the IDE interface is integrated into the Intel 815E or 810E chip set, depending on the model. The chip set connects directly to the PCI bus and is designed to allow concurrent operations on the PCI bus and the IDE bus. The 815E chip set is capable of supporting PIO mode 0-4 devices and IDE DMA mode 0-5 devices, and ATA 100 transfers of up to 100 Megabytes per second. The 810E chip set is capable of supporting PIO mode 0-4 devices and IDE DMA mode 0-4 devices, and ATA 66 transfers of up to 66 Megabytes per second.

The IDE devices receive their power through a four-position power cable containing +5 v dc, +12 v dc, and ground voltage. When devices are added to the IDE interface, one device is designated as the master (primary) device and another is designated as the slave (secondary) device. These designations are determined by jumpers on each device. Two connectors are provided on the system board for the IDE interface. One connector is designated Primary, and the other connector is designated Secondary. Each connector allows two devices to be attached, allowing up to four devices to be attached to the IDE interface. For information on the connector pin assignments, see "IDE connectors" on page 33.

For the IDE interface, no resource assignments are given in the system memory or the direct memory access (DMA) channels. For information on the resource assignments, see Table 36 on page 49.

USB interface

USB technology is a standard feature of the computer. The A40 and A40p system boards provide the USB interface with two dual channels integrated into the chip set. The A20 system board provides the USB interface with one dual channel integrated into the chip set. A USB-enabled device can attach to a connector, and if that device is a hub, multiple peripheral devices can attach to the hub and be used by the system. The USB connectors use Plug and Play technology for installed devices. The speed of the USB is up to 12 MBps with a maximum of 127 peripheral devices. The USB is compliant with *Universal Host Controller Interface Guide 1.0*.

Features provided by USB technology include:

- Support for hot-pluggable devices
- Support for concurrent operation of multiple devices
- Suitability for different device speeds
- Support for cable length of up to five meters (16 ft. 5 in) from host to hub or from hub to hub
- Wide range of packet sizes
- Limited power to hubs

For information on the connector pin assignments for the USB interface, see “USB port connectors” on page 29.

Super I/O controller

Control of the integrated I/O and diskette drive controllers is provided by a single module. This module, which supports Plug and Play, controls the following features:

- Diskette drive interface
- Serial port
- Parallel port
- Keyboard and mouse ports
- MIDI/joystick port (A20 models only)

Diskette drive interface

The NetVista computer diskette drive subsystem supports the following devices:

- 1.44 MB, 3.5-inch diskette drive
- 1.44 MB, 3.5-inch 3-mode drive for Japan (no BIOS support for 3-mode drive)
- 1.2 MB, 5.25-inch diskette drive
- 1 Mbps, 500 Kbps, or 250 Kbps internal tape drive

Note: A 2.88 MB 3.5-inch diskette drive is not supported.

One 34-pin connector is provided on the system board for diskette drive support. For information about the connector pin assignments, see “Diskette drive connector” on page 32.

A setting in the Configuration/Setup Utility program enables or disables diskette write protection.

Serial ports

Two UART serial ports are integrated into the system board of A40 and A40p models. A20 models come with one serial port. The serial ports include 16-byte, first-in first-out (FIFO) buffers and have programmable baud rate generators. The serial ports are NS16450 and PC16550A compatible.

For information on the connector pin assignments, see “Serial connector” on page 30.

Note: The current loop interface is not supported.

The following figure shows the default serial port assignments in the configuration.

Table 1. Default serial port assignments

Port assignment	Address range (hex)	IRQ level
Serial 1	03F8–03FF	IRQ 4
Serial 2 (A40 and A40p models only)	02F8–02FF	IRQ 3

Parallel port

Integrated into the system board is support for ECP, EPP, and standard parallel port (SPP) modes. The modes of operation are selected through the Configuration/Setup Utility program with the default mode set to SPP. The ECP and EPP modes are compliant with IEEE 1284.

The following table shows the possible parallel port assignments used in the configuration.

Table 2. Parallel port assignments

Port assignment	Address range (hex)	IRQ level	DMA
Parallel 1	03BC–03BE	IRQ 7	3
Parallel 2	0378–037F	IRQ 7	3
Parallel 3	0278–027F	IRQ 7	3

The default setting for the parallel port is Parallel 2 ECP mode.

The system board has one connector for the parallel port. For information about the connector pin assignments, see “Parallel connector” on page 31.

Keyboard and mouse ports

The keyboard and mouse subsystem is controlled by a general purpose 8-bit microcontroller that is compatible with 8042AH and PC87911. The controller consists of 256 bytes of data memory and 2 KB of read-only memory (ROM).

The controller has two logical devices: one controls the keyboard, and the other controls the mouse. The keyboard has two fixed I/O addresses and a fixed interrupt request (IRQ) line and can operate without the mouse. The mouse cannot operate without the keyboard because, although it has a fixed IRQ line, the mouse relies on assignments given in the system memory addresses or DMA channels. For information on the resource assignments, see Table 35 on page 49 and Table 36 on page 49.

The system board has one connector for the keyboard port and one connector for the mouse port. For information on the connector pin assignments, see Table 36 on page 49.

Low pin-count bus

The low-pin-count (LPC) bus enables device connections to the Super I/O without industry standard architecture (ISA) or X-Bus. The NetVista A40 and A40p computer uses the LPC47M133 Super I/O chip. The NetVista A20 computer uses the Windbond 83627HF Super I/O chip. The chip includes the following:

- Diskette drive controller
- Keyboard and mouse controller
- IEEE 1284 parallel port

- Two UART serial ports
- Fan tacit monitoring
- MIDI/joystick port (A20 models only)
- PC99 compliance
- Advanced configuration and power interface (ACPI) compliance

Video subsystem

The NetVista computer comes with one of the following graphics adapters:

- Intel 815E/810E integrated graphics subsystem with 3D capability
- NVidia 4x AGP adapter with 16 MB synchronous dynamic random access memory (SDRAM)

Features of the Intel 815E/810E integrated graphics subsystem

The Intel 815E/810E integrated graphics subsystem is a 2D/3D video subsystem that includes a random access memory and digital-to-analog converter (RAMDAC), video POST and BIOS code and a DDC2B monitor connector.

The Intel 815E/810E GMCH graphics subsystem is compatible with video graphics adapter (VGA) function, supports all VGA video modes, and contains the following advanced features:

- Integrated video subsystem on the chip includes 2D and 3D graphics engines
- Integrated hardware motions compensation engine
- Intel dynamic video memory (DVM) technology
- Direct3D optimized 3D engine
- 230 MHz, internal RAMDAC that supports up to 85 Hz refresh rate at 1280 x 1024 resolution
- Full MPEG-2 motion compensation for software assisted DVD video playback
- Multiple monitor support
- Compliance with the following standards:
 - VESA VBE V2.0
 - DDC2B
- Advanced power-management (APM) support
- Complete Plug and Play support

Features of the NVidia 4x AGP adapter

The NVidia 4x AGP adapter is a 2D/3D video adapter with 16 MB SDRAM that includes:

- AGP 4x interface
- 128-bit TwiN-Textel architecture (TNT2 M64)
- 16 MB SDRAM frame buffer with 64-bit interface
- 64 MB frame buffer supporting SuperScene, full-scene, multi sampled anti-aliasing
- 250 MHz, internal RAMDAC that supports up to 85 Hz refresh rate at 1280 x 1024 resolution
- High-resolution support up to 1600 x 1200
- High-performance 128-bit 2D/graphical user interface (GUI)/DirectDraw acceleration
- Fast 32-bit VGA/Super VGA (SVGA) support
- High performance implementation of Direct 3D and OpenGL standards
- Video acceleration for DirectShow, MPEG-1, MPEG-2, and Indeo
- Multiple monitor support
- Advanced power-management support
- Complete Plug and Play support
- Compliance with the following standards:
 - AGP 2.0
 - VESA VBE V2.0/3.0
 - DDC2B

Monitor support

The video subsystem provides a 15-pin analog monitor connector for the integrated video subsystem on the system board in addition to a 15-pin analog connector on a graphics adapter (if present). When an AGP graphics adapter is installed in the computer, the 15-pin monitor connector for the integrated video subsystem will go unused. For multiple monitor support, either the integrated video subsystem or AGP adapter must be used in conjunction with a PCI graphics adapter. For information on connector pin assignments, see “Monitor connector” on page 29.

Audio subsystem

The NetVista computer comes with an integrated audio controller. These models are capable of playing and recording sounds and support SoundBlaster, Adlib, and Microsoft Windows Sound System applications.

The device drivers are on the hard disk and are also available on the Product Recovery Program on the hidden partition of the hard drive if the computer comes with preinstalled software.

If you connect an optional device to the audio connectors, follow the instructions provided by the manufacturer. (Note that device drivers might be required. If necessary, contact the manufacturer for information on these device drivers.)

The following connectors are available on the integrated audio controller:

- *Line/headphone out* connector for connecting headphones or powered speakers. To hear audio from the adapter you must connect headphones or a set of speakers to the Line out port. These speakers must be powered with a built-in amplifier. In general, powered speakers are available with a wide range of features and power outputs.
- *Line in* connector for connecting musical devices, such as a portable CD player or stereo system.
- *Microphone* connector for attaching a microphone.

Network connection

Some models of the NetVista computer have an integrated Ethernet controller.

Features of the Ethernet controller are:

- Operates in shared 10BASE-T or 100BASE-TX environment
- Transmits and receives data at 10 Mbps or 100 Mbps
- Has a RJ-45 Ethernet connector for LAN attachment
- Supports Wake on LAN
- Supports Remote Program Load (RPL) and Dynamic Host Configuration Protocol (DHCP)

Real-time clock and CMOS

The real-time clock is a low-power clock that provides a time-of-day clock and a calendar. The clock settings are maintained by the battery when the power cord is removed.

The system uses 242 bytes of CMOS memory to store data. The CMOS memory is erased if the CMOS clear/recovery jumper is moved.

To locate the battery, see “System board layout for the NetVista A40 and A40p computer” on page 3 or “System board layout for the A20 model computer” on page 4.

Flash EEPROM

The system board uses 4 Mb of flash electrically erasable, programmable, read-only memory (EEPROM) to store the BIOS, IBM logo, Configuration/Setup Utility, and Plug and Play data.

If necessary, the EEPROM can be easily updated using a stand-alone program that is available on a 3.5-inch diskette. For information to obtain the latest version of the Flash Update Utility program, see the *NetVista User Guide*.

Expansion adapters

The NetVista small form factor desktop model computer has two 32-bit, 33 MHz PCI slots. The NetVista desktop model computer has three 32-bit 33 MHz PCI slots. These connectors support the 5 V signaling environment that is defined in *PCI Local Bus Specification 2.2*. Some models also have a preinstalled AGP adapter.

The NetVista computer has a 3-pin connector on the system board that provides the auxiliary 5 volts (AUX5) and wake-up signal connections. Some Wake on LAN adapters have two connectors: a 3-pin, right-angle header for AUX5, and a 2-pin straight connector for the wake-up signal. These Wake on LAN connector options include a Y-cable that has a 3-pin system-board connector on one end and splits into the 3-pin and 2-pin connectors that connect to the adapter.

For information on installing adapters, see the *NetVista User Guide*.

For information on the connector pin assignments, see “32-bit PCI connectors” on page 37.

Cable connectors

Connectors for attaching peripheral devices are provided on the back of the computer. The connectors are:

- Monitor (SVGA)
- Keyboard
- Mouse
- Serial (2) (A20 models — 1)
- Parallel
- USB (2)
- Audio connectors for line in, line/headphone out, and microphone
- MIDI/joystick (A20 models only)
- Ethernet (some models)

For pin assignment details on connectors, see Appendix A, “Connector-pin assignments,” on page 29.

Connectors for features integrated into the system board can be identified by an icon directly below each connector. A connector located on an adapter might not have an identifying icon.

The following illustration shows the connector panel for the NetVista small form factor desktop model computer.

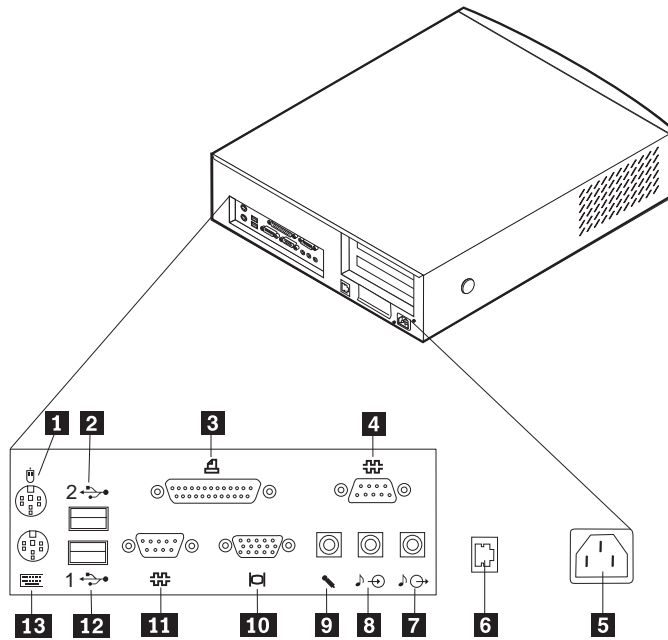

- 1** Mouse connector
- 2** USB connector 2
- 3** Parallel connector
- 4** Serial connector
- 5** Power connector
- 6** Ethernet connector
- 7** Audio line out connector
- 8** Audio line in connector
- 9** Microphone connector
- 10** Monitor connector
- 11** Serial connector 1
- 12** USB connector 1
- 13** Keyboard connector

The following illustration shows the connector panel for the NetVista desktop model computer.

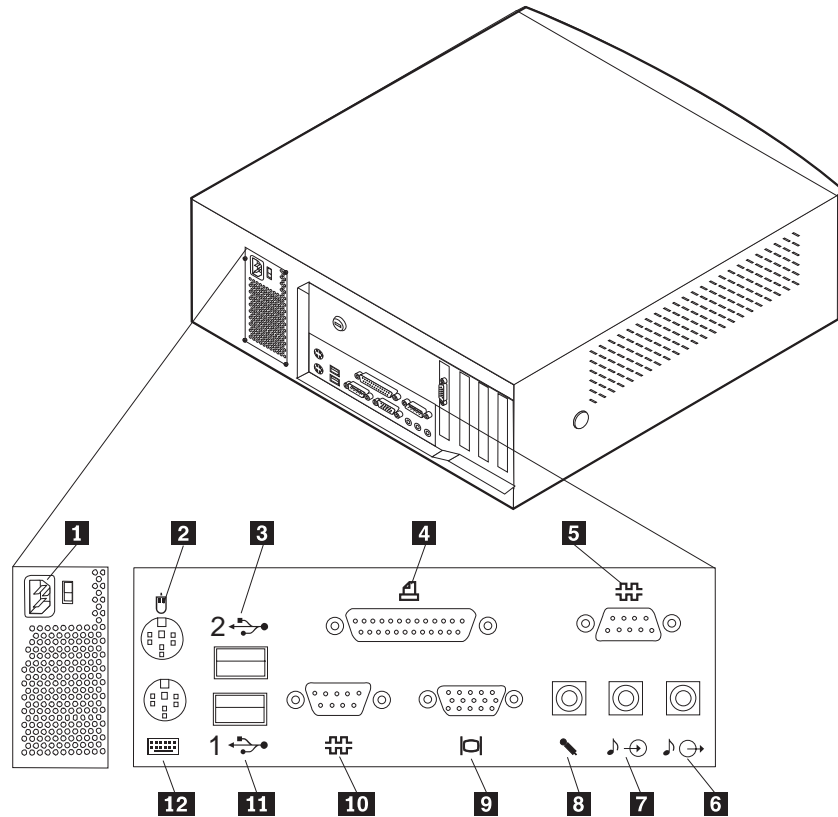

- 1** Power connector
- 2** Mouse connector
- 3** USB connector 2
- 4** Parallel connector
- 5** Serial connector 2 (MIDI/joystick connector for some models)
- 6** Audio line/headphone out
- 7** Audio line in
- 8** Microphone
- 9** Monitor connector
- 10** Serial connector 1
- 11** USB connector 1
- 12** Keyboard connector

Note: On A20 models, the audio line out and microphone connector are reversed in position on the back of the computer, and a joystick/MIDI connector in the place of serial connector 2.

Chapter 3. Physical specifications

This section lists the physical specifications for the NetVista computer. The NetVista small form factor desktop model has two 32-bit PCI expansion slots and three drive bays. The NetVista desktop model computer has three 32-bit PCI expansion slots, one AGP slot (some models only), and four drive bays.

Note: The computer is classified as a Class A or Class B digital device. See the *NetVista User Guide* for further information about this classification.

Physical specifications — A40 and A40p small form factor desktop model

<p>Dimensions</p> <p>Height: 87 mm (3.43 in.) Width: 345 mm (13.6 in.) Depth: 360 mm (14.2 in.)</p> <p>Weight</p> <p>Minimum configuration as shipped: 8.2 kg (18 lb) Maximum configuration: 8.6 kg (19 lb)</p> <p>Environment</p> <p>Air temperature:</p> <p>System on: 10° to 35°C (50° to 95° F) System off: 10° to 43° C (50° to 110° F) Maximum altitude: 2134 m (7000 ft)</p> <p>Note: The maximum altitude, 2134 m (7000 ft), is the maximum altitude at which the specified air temperatures apply. At higher altitudes, the maximum air temperatures are lower than those specified.</p> <p>Humidity:</p> <p>System on: 8% to 80% System off: 8% to 80%</p> <p>Electrical input</p> <p>Input voltage:</p> <p>Minimum: 90 V ac Maximum: 265 V ac Input frequency range: 47–63 Hz</p> <p>Input kilovolt-amperes (kVA) (approximate):</p> <p>Minimum configuration as shipped: 0.08 kVA Maximum configuration: 0.16 kVA</p> <p>Note: Power consumption and heat output vary depending on the number and type of optional features installed and the power-management optional features in use.</p>	<p>Heat output (approximate) in British thermal units (Btu) per hour:</p> <p>Minimum configuration: 205 Btu/hr (60 watts) Maximum configuration: 375 Btu/hr (110 watts)</p> <p>Airflow</p> <p>Approximately 0.25 cubic meters per minute (9 cubic feet per minute) maximum</p> <p>Acoustical noise-emission values</p> <p>Average sound-pressure levels:</p> <p>At operator position:</p> <p>Idle: 38 dBA Operating: 43 dBA</p> <p>At bystander position - 1 meter (3.3 ft):</p> <p>Idle: 33 dBA Operating: 37 dBA</p> <p>Declared (upper limit) sound-power levels:</p> <p>Idle: 4.8 bels Operating: 5.1 bels</p> <p>Note: These levels were measured in controlled acoustical environments according to the procedures specified by the American National Standards Institute (ANSI) S12.10 and ISO 7779 and are reported in accordance with ISO 9296. Actual sound-pressure levels in a given location might exceed the average values stated because of room reflections and other nearby noise sources. The declared sound-power levels indicate an upper limit, below which a large number of computers will operate.</p>
--	---

Physical specifications — A40 and A40p desktop model

<p>Dimensions</p> <p>Height: 140 mm (5.5 in.) Width: 425 mm (16.7 in.) Depth: 425 mm (16.7 in.)</p> <p>Weight</p> <p>Minimum configuration as shipped: 9.4 kg (20 lb) Maximum configuration: 11.3 kg (25.0 lb)</p> <p>Environment</p> <p>Air temperature:</p> <p>System on: 10° to 35°C (50° to 95° F) System off: 10° to 43° C (50° to 110° F) Maximum altitude: 2134 m (7000 ft)</p> <p>Note: The maximum altitude, 2134 m (7000 ft), is the maximum altitude at which the specified air temperatures apply. At higher altitudes, the maximum air temperatures are lower than those specified.</p> <p>Humidity:</p> <p>System on: 8% to 80% System off: 8% to 80%</p> <p>Electrical input</p> <p>Input voltage:</p> <p>Low range:</p> <p>Minimum: 90 V ac Maximum: 137 V ac Input frequency range: 57–63 Hz Voltage switch setting: 115 V ac</p> <p>High range:</p> <p>Minimum: 180 V ac Maximum: 265 V ac Input frequency range: 47–53 Hz Voltage switch setting: 230 V ac</p> <p>Input kilovolt-amperes (kVA) (approximate):</p> <p>Minimum configuration as shipped: 0.08 kVA Maximum configuration: 0.30 kVA</p> <p>Note: Power consumption and heat output vary depending on the number and type of optional features installed and the power-management optional features in use.</p>	<p>Heat output (approximate) in British thermal units (Btu) per hour:</p> <p>Minimum configuration: 240 Btu/hr (75 watts) Maximum configuration: 705 Btu/hr (207 watts)</p> <p>Airflow</p> <p>Approximately 0.5 cubic meters per minute (18 cubic feet per minute) maximum</p> <p>Acoustical noise-emission values</p> <p>Average sound-pressure levels:</p> <p>At operator position:</p> <p>Idle: 38 dBA Operating: 43 dBA</p> <p>At bystander position - 1 meter (3.3 ft):</p> <p>Idle: 33 dBA Operating: 37 dBA</p> <p>Declared (upper limit) sound-power levels:</p> <p>Idle: 4.8 bels Operating: 5.1 bels</p> <p>Note: These levels were measured in controlled acoustical environments according to the procedures specified by the American National Standards Institute (ANSI) S12.10 and ISO 7779 and are reported in accordance with ISO 9296. Actual sound-pressure levels in a given location might exceed the average values stated because of room reflections and other nearby noise sources. The declared sound-power levels indicate an upper limit, below which a large number of computers will operate.</p>
---	---

Physical specifications — A20 desktop model

<p>Dimensions</p> <p>Height: 140 mm (5.5 in.) Width: 425 mm (16.7 in.) Depth: 425 mm (16.7 in.)</p> <p>Weight</p> <p>Minimum configuration as shipped: 9.4 kg (20 lb) Maximum configuration: 11.3 kg (25.0 lb)</p> <p>Environment</p> <p>Air temperature:</p> <p>System on: 10° to 35°C (50° to 95° F) System off: 10° to 43° C (50° to 110° F) Maximum altitude: 2134 m (7000 ft)</p> <p>Note: The maximum altitude, 2134 m (7000 ft), is the maximum altitude at which the specified air temperatures apply. At higher altitudes, the maximum air temperatures are lower than those specified.</p> <p>Humidity:</p> <p>System on: 8% to 80% System off: 8% to 80%</p> <p>Electrical input</p> <p>Input voltage:</p> <p>Low range:</p> <p>Minimum: 90 V ac Maximum: 137 V ac Input frequency range: 57–63 Hz Voltage switch setting: 115 V ac</p> <p>High range:</p> <p>Minimum: 180 V ac Maximum: 265 V ac Input frequency range: 47–53 Hz Voltage switch setting: 230 V ac</p> <p>Input kilovolt-amperes (kVA) (approximate):</p> <p>Minimum configuration as shipped: 0.52 kVA Maximum configuration: 1.50 kVA</p> <p>Note: Power consumption and heat output vary depending on the number and type of optional features installed and the power-management optional features in use.</p>	<p>Heat output (approximate in British thermal units (Btu) per hour:</p> <p>Minimum configuration: 240 Btu/hr (75 watts) Maximum configuration: 705 Btu/hr (207 watts)</p> <p>Airflow</p> <p>Approximately 0.5 cubic meters per minute (18 cubic feet per minute) maximum</p> <p>Acoustical noise-emission values</p> <p>Average sound-pressure levels:</p> <p>At operator position:</p> <p>Idle: 38 dBA Operating: 43 dBA</p> <p>At bystander position - 1 meter (3.3 ft):</p> <p>Idle: 33 dBA Operating: 37 dBA</p> <p>Declared (upper limit) sound-power levels:</p> <p>Idle: 4.5 bels Operating: 4.8 bels</p> <p>Note: These levels were measured in controlled acoustical environments according to the procedures specified by the American National Standards Institute (ANSI) S12.10 and ISO 7779 and are reported in accordance with ISO 9296. Actual sound-pressure levels in a given location might exceed the average values stated because of room reflections and other nearby noise sources. The declared sound-power levels indicate an upper limit, below which a large number of computers will operate.</p>
---	--

Chapter 4. Power supply

The NetVista small form factor desktop model computer uses a 110-watt power supply. The NetVista desktop model computer uses a 155-watt power supply. The power supply provides power for the Pentium III microprocessor, core chip set, and PCI adapters. Also included is an auxiliary 5-volt (AUX 5) supply to provide power to power-management circuitry and the Wake on LAN feature. The power supply converts the ac input voltage into five dc output voltages and provides power for the following:

- System board
- Memory card
- Adapters
- Internal drives
- Keyboard and auxiliary devices
- USB devices

A logic signal on the power connector controls the power supply; the front panel switch is not directly connected to the power supply.

The power supply connects to the system board with a 2-pin by 10-pin connector.

Power input

The following tables show the power-input specifications for the 155-watt and 110-watt power supplies.

Table 3. Power input requirements for the 155-watt power supply

Specification	Measurements
Input voltage, low range	90 (min) to 137 (max) V ac
Input voltage, high range	180 (min) to 265 (max) V ac
Input frequency	50 Hz \pm 3 or 60 Hz \pm 3 Hz

Table 4. Power input requirements for the 110-watt power supply

Specification	Measurements
Input voltage	90 (min) to 265 (max) V ac
Input frequency	50 Hz \pm 3 or 60 Hz \pm 3 Hz

Power output

The power supply outputs shown in the following figures include the current-supply capability of all the connectors, including system board, direct access storage drive (DASD), PCI, and auxiliary outputs.

Table 5. Power output for the 155-watt power supply

Output voltage	Regulation	Minimum current	Maximum current
+5 volts	+5% to -4%	0.2 A	15.0 A

Table 5. Power output for the 155-watt power supply

Output voltage	Regulation	Minimum current	Maximum current
+12 volts	+5% to -5%	0.2 A	4.2 A
+3.3 volts	±5%	0.2 A	12.0 A
-12 volts	±10%	0 A	0.4 A
+5 volts (auxiliary)	+5% to -5%	5 mA	2.0 A

Note: The total combined 3.3 V and 5 V power must not exceed 100 watts.

Table 6. Power output for the 110-watt power supply

Output voltage	Regulation	Minimum current	Maximum current
+5 volts	+5% to -4%	0.2 A	10.0 A
+12 volts	+5% to -5%	0.02 A	2.0 A
+3.3 volts	±5%	0.2 A	8.0 A
-12.0 volts	±10%	0 A	0.4 A
+5 volts (auxiliary)	+5 to -5%	5 mA	3.0 A

Note: The total combined 3.3 V and 5 V power must not exceed 65 watts.

Component outputs

The power supply provides separate voltage sources for the system board and internal storage devices. The following figures show the approximate power that is provided for specific system components. Many components draw less current than the maximum shown.

Table 7. Keyboard port power

Supply voltage	Maximum current	Regulation limits
+5.0 V dc	275 mA	+5.0% to -4.0%

Table 8. Mouse port power

Supply voltage	Maximum current	Regulation limits
+5.0 V dc	275 mA	+5.0% to -4.0%

Table 9. USB port power

Supply voltage	Maximum current	Regulation limits
+5.0 V dc	500 mA	+5.0% to -4.0%

Output protection

The power supply protects against output overcurrent, overvoltage, and short circuits. See the power supply specifications in Chapter 4, "Power supply," on page 21 for details.

An overload that is placed on any dc output (between outputs or between an output and dc return) latches all dc outputs into a shutdown state, with no damage to the power supply. If this shutdown state occurs, the power supply returns to normal operation only after the fault has been removed and the power switch has been turned off for at least one second.

If an overvoltage fault occurs (in the power supply), the power supply latches all dc outputs into a shutdown state before any output exceeds 130% of the nominal value of the power supply.

Internal device connectors

The power supply for the NetVista computer has four 4-pin connectors for internal devices. The total power used by the connectors must not exceed the amount shown in “Component outputs” on page 22. For connector pin assignments, see Table 25 on page 41 and Table 26 on page 42.

Chapter 5. System software

This section briefly describes some of the system software included with the computer.

BIOS

The NetVista computer uses the IBM BIOS, which is stored in flash EEPROM). Some of the features of the BIOS are:

- PCI support in accordance with *PCI BIOS Specification 2.2*
- Microsoft PCI IRQ Routing Table
- Plug and Play support in accordance with *Plug and Play Specification 1.1a*
- Wake on LAN support
- Asset ID support (some models)
- RPL and DHCP
- Startable CD-ROM support
- Alternate startup sequence support
- IBM look and feel, such as screen arrangements
- *Advanced Configuration and Power Interface (ACPI) 1.0b*
- IDE logical block addressing (LBA) support
- LS 120 support
- Desktop Management (DM) BIOS 2.0 (DMI compliant)
- PC99 compliance

Plug and Play

Support for Plug and Play conforms to the following:

- *Plug and Play BIOS Specification 1.0a*
- *Plug and Play BIOS Extension Design Guide 1.0*
- *Plug and Play BIOS Specification, Errata, and Clarifications 1.0a*
- *Guide to Integrating the Plug and Play BIOS Extensions with system BIOS 1.2*
- Plug and Play kit for DOS and Windows

POST

IBM POST code is used. Also, initialization code is included for the on-board system devices and controllers.

POST error codes include text messages for determining the cause of an error. For more information, see the *NetVista User Guide* or the *NetVista Hardware Maintenance Manual*.

Configuration/Setup Utility program

The Configuration/Setup Utility program provides menus for selecting options for devices, I/O ports, date and time, system security, start options, advanced setup, and power management.

More information on using the Configuration/Setup Utility program is provided in *NetVista User Guide*.

Advanced Power Management (APM)

The NetVista computer comes with built-in energy-saving capabilities. Advanced Power Management (APM) is a feature that reduces the power consumption of systems when they are not being used. When enabled, APM initiates reduced-power modes for the monitor, microprocessor, and hard disk drive after a specified period of inactivity.

The BIOS supports APM 1.2. This enables the system to enter a power-managed state, which reduces the power drawn from the ac electrical outlet. Advanced Power Management is enabled and controlled through the Configuration/Setup Utility program.

For more information on APM, see *NetVista User Guide* and *Understanding Your Personal Computer*.

Advanced Configuration and Power Interface (ACPI)

Advanced Configuration and Power Interface (ACPI) BIOS mode enables the operating system to control the power-management features of the computer. Not all operating systems support ACPI BIOS mode. See the operating system documentation to determine if ACPI is supported.

Flash update utility program

The flash update utility program is a stand-alone program to support flash updates. This utility program updates the BIOS code and can change the machine readable information (MRI) to different languages.

The flash update utility program is available at <http://www.ibm.com/pc/support> on the World Wide Web. Type the machine type and model number in the **Quick Path** field and look for the **Downloadable Files** link. Use the menu choices to narrow the links to the applicable file for your computer.

Diagnostic program

The diagnostic program that comes with the NetVista computer, IBM Enhanced Diagnostics, is provided on the hidden partition of the hard disk if your computer comes with preinstalled software. It runs independently of the operating system. You can use IBM Enhanced Diagnostics to diagnose and repair problems with the computer. You can download the latest version from <http://www.ibm.com/pc/support> on the World Wide Web. Type the machine type and model number in the **Quick Path** field and look for the **Downloadable Files** link. Use the menu choices to narrow the links to the applicable file for your computer. For more information on this diagnostic program, see *NetVista User Guide*.

Chapter 6. System compatibility

This chapter discusses some of the hardware, software, and BIOS compatibility issues that must be considered when designing application programs for the computer.

Hardware compatibility

The functional interfaces are compatible with the following interfaces:

- Intel 8259 interrupt controllers
- National Semiconductor NS16450 and NS16550A serial communication controllers
- Motorola MC146818 Time of Day Clock command and status (CMOS reorganized)
- Intel 8254 timer, driven from a 1.193 MHz clock (channels 0, 1, and 2)
- Intel 8237 DMA controller, except for the Command and Request registers and the Rotate and Mask functions; the Mode register is partially supported
- Intel 8272 or 82077 diskette drive controllers
- Intel 8042 keyboard controller at addresses hex 0060 and hex 0064
- All video standards using VGA, enhanced graphics adapter (EGA), color graphics adapter (CGA), monochrome graphics adapter (MDA), and Hercules modes
- Parallel printer ports (Parallel 1, Parallel 2, and Parallel 3) in compatibility mode

Use this information to develop application programs. Whenever possible, use the BIOS as an interface to hardware to provide maximum compatibility and portability of applications among systems.

Hardware interrupts

Hardware interrupts are level-sensitive for PCI interrupts. The interrupt controller clears the in-service register bit when the interrupt routine sends an End-of-Interrupt (EOI) command to the controller. The EOI command is sent regardless of whether the incoming interrupt request to the controller is active or inactive.

The interrupt-in-progress latch is readable at an I/O address bit position. This latch is read during the interrupt service routine and might be reset by the read operation or it might require an explicit reset.

Note: For performance and latency considerations, designers might want to limit the number of devices sharing an interrupt level.

With level-sensitive interrupts, the interrupt controller requires that the interrupt request be inactive at the time the EOI command is sent; otherwise, a new interrupt request will be detected. To avoid this, a level-sensitive interrupt handler must clear the interrupt condition (usually by a read or write operation to an I/O port on the device causing the interrupt). After processing the interrupt, the interrupt handler does the following:

1. Clears the interrupt
2. Waits one I/O delay
3. Enables the interrupt through the Set Interrupt Enable Flag command

Hardware interrupt IRQ9 is defined as the replacement interrupt level for the cascade level IRQ2. Program interrupt sharing is implemented on IRQ2, interrupt hex 0A. The

following processing occurs to maintain compatibility with the IRQ2 used by IBM computer products:

1. A device drives the interrupt request active on IRQ2 of the channel.
2. This interrupt request is mapped in hardware to IRQ9 input on the second interrupt controller.
3. When the interrupt occurs, the system microprocessor passes control to IRQ9 (interrupt hex 71) interrupt handler.
4. This interrupt handler performs an EOI command to the second interrupt controller and passes control to the IRQ2 (interrupt hex 0A) interrupt handler.
5. This IRQ2 interrupt handler, when handling the interrupt, causes the device to reset the interrupt request before performing an EOI command to the master interrupt controller that finishes servicing the IRQ2 request.

Hard disk drives and controller

Reading from and writing to the hard disk is initiated in the same way as in other IBM computer products; however, new functions are supported.

Machine-sensitive programs

Programs can select machine-specific features, but they must first identify the machine and model type. IBM has defined methods for uniquely determining the specific machine type. The machine model byte can be found through Interrupt 15H, Return Configuration Parameters function (AH)=(COH).

Appendix A. Connector-pin assignments

The following figures show the pin assignments for various system board connectors.

External connectors

The following information shows the pin assignments for external connectors.

Monitor connector

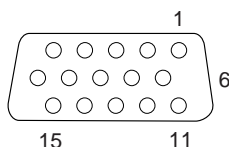

Table 10. Monitor connector-pin assignments

Pin	Signal	I/O	Pin	Signal	I/O
1	Red	O	9	+5 V dc, used by DDC2B	
2	Green	I	10	Ground	
3	Blue	O	11	Monitor ID 0 - not used	
4	Monitor ID 2 - not used	I	12	DDC2B data	I/O
5	Ground		13	Horizontal sync	O
6	Red ground		14	Vertical sync	O
7	Green ground		15	DDC2B clock	I/O
8	Blue ground				

USB port connectors

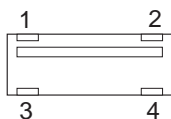

Table 11. USB port connector-pin assignments

Pin	Connector
1	VCC
2	-Data
3	+Data
4	Ground

Keyboard and mouse connectors

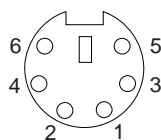

Table 12. Keyboard connector-pin assignments

Pin	Signal	I/O	Pin	Signal	I/O
1	Data	I/O	4	+5 V dc	
2	Reserved	I/O	5	Clock	I/O
3	Ground		6	Reserved	I/O

Table 13. Mouse connector-pin assignments

Pin	Signal	I/O	Pin	Signal	I/O
1	Data	I/O	4	+5 V dc	
2	Reserved	I/O	5	Clock	I/O
3	Ground		6	Reserved	

Serial connector

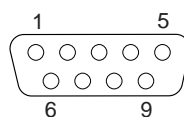

Table 14. Serial connector-pin assignments

Pin	Signal	I/O	Pin	Signal	I/O
1	Data carrier detect	I	6	Data set ready	I
2	Receive data#	I	7	Request to send	O
3	Transmit data#	O	8	Clear to send	I
4	Data terminal read	O	9	Ring indicator	I
5	Ground				

Parallel connector

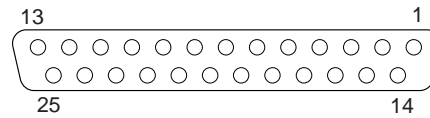

Table 15. Parallel connector-pin assignments

Pin	Signal	I/O	Pin	Signal	I/O
1	STROBE#	I/O	14	AUTO FD XT#	O
2	Data bit 0	I/O	15	ERROR#	I
3	Data bit 1	I/O	16	INIT#	O
4	Data bit 2	I/O	17	SLCT IN#	O
5	Data bit 3	I/O	18	Ground	
6	Data bit 4	I/O	19	Ground	
7	Data bit 5	I/O	20	Ground	
8	Data bit 6	I/O	21	Ground	
9	Data bit 7	I/O	22	Ground	
10	ACK#	I	23	Ground	
11	BUSY	I	24	Ground	
12	PE	I	25	Ground	
13	SLCT	I			

Ethernet connector

Table 16. Ethernet connector-pin assignments

Pin	Signal	I/O	Pin	Signal	I/O
1	TxD+	O	5	Ground	
2	TxD-	O	6	RxD-	I
3	RxD+	I	7	Ground	
4	Ground		8	Ground	

MIDI/joystick connector

The external MIDI/joystick connector attaches to the system board through a signal cable that connects to an internal connector on the system board. The following illustration shows the external connector.

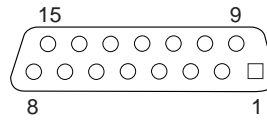

Table 17. MIDI/Joystick external connector-pin assignments

Pin	Signal	Pin	Signal
1	+5 v dc	9	+5 v dc
2	JAB1	10	JBB1
3	JACX	11	JBCX
4	Ground	12	MIDI out
5	Ground	13	JBCY
6	JACY	14	JBB2
7	JAB2	15	MIDI in
8	+5		

Internal connectors

The following figures show the connector-pin assignments for various internal connectors on the system board and memory card.

Diskette drive connector

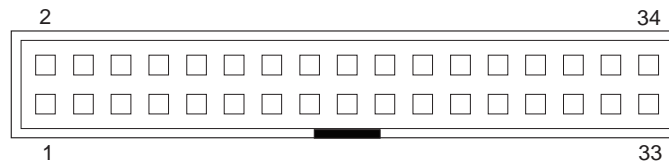

Table 18. Diskette drive connector-pin assignments

Pin	Signal	I/O	Pin	Signal	I/O
1	Ground	I	18	Direction in#	
2	High density select	O	19	Ground	
3	Ground		20	Step#	O
4	Not connected		21	Ground	
5	Ground		22	Write data#	O

Table 18. Diskette drive connector-pin assignments

Pin	Signal	I/O	Pin	Signal	I/O
6	Data rate 0		23	Ground	
7	Ground		24	Write enable#	O
8	Index#		25	Ground	
9	Reserved		26	Track0#	I
10	Motor enable 0#	O	27	Ground	
11	Ground		28	Write protect#	I
12	Drive select 1#	O	29	Ground	I
13	Ground		30	Read data#	I
14	Drive select 0#	O	31	Ground	
15	Ground		32	Head 1 select#	O
16	Motor enable 1#	O	33	Ground	O
17	N/C	I	34	Diskette change#	I

IDE connectors

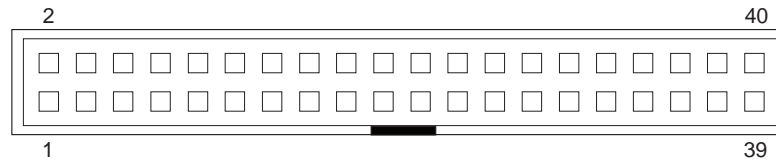

Table 19. IDE connector-pin assignments

Pin	Signal	I/O	Pin	Signal	I/O
1	N/C	O	21	SDDREQ	
2	Ground		22	Ground	
3	Data bus bit 7	I/O	23	I/O write	O
4	Data bus bit 8	I/O	24	Ground	
5	Data bus bit 6	I/O	25	I/O read	O
6	Data bus bit 9	I/O	26	Ground	
7	Data bus bit 5	I/O	27	I/O channel ready	I
8	Data bus bit 10	I/O	28	Ground	O
9	Data bus bit 4	I/O	29	DMAACK	
10	Data bus bit 11	I/O	30	Ground	
11	Data bus bit 3	I/O	31	IRQ	I
12	Data bus bit 12	I/O	32	CS16#	I
13	Data bus bit 2	I/O	33	SA1	O
14	Data bus bit 13	I/O	34	IDE66 detect	I

Table 19. IDE connector-pin assignments

Pin	Signal	I/O	Pin	Signal	I/O
15	Data bus bit 1	I/O	35	SA0	O
16	Data bus bit 14	I/O	36	SA2	O
17	Data bus bit 0	I/O	37	CS0#	O
18	Data bus bit 15	I/O	38	CS1	O
19	Ground		39	Active#	I
20	Key (Reserved)		40	Ground	

Memory connectors

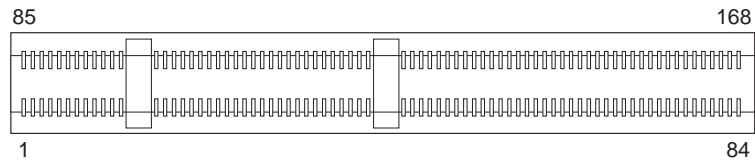

Table 20. System memory connector-pin assignments

Pin	Signal	Pin	Signal	Pin	Signal	Pin	Signal
1	VSS	43	VSS	85	VSS	127	VSS
2	DQ0	44	DU	86	DQ32	128	CKE0
3	DQ1	45	/S2	87	DQ33	129	NC
4	DQ2	46	DQMB2	88	DQ34	130	DQMB6
5	DQ3	47	DQMB3	89	DQ35	131	DQMB7
6	VCC	48	DU	90	VCC	132	A13
7	DQ4	49	VCC	91	DQ36	133	VCC
8	DQ5	50	NC	92	DQ37	134	NC
9	DQ6	51	NC	93	DQ38	135	NC
10	DQ7	52	NC	94	DQ39	136	NC
11	DQ8	53	NC	95	DQ40	137	NC
12	VSS	54	VSS	96	VSS	138	VSS
13	DQ9	55	DQ16	97	DQ41	139	DQ48
14	DQ10	56	DQ17	98	DQ42	140	DQ49
15	DQ11	57	DQ18	99	DQ43	141	DQ50
16	DQ12	58	DQ19	100	DQ44	142	DQ51
17	DQ13	59	VCC	101	DQ45	143	VCC
18	VCC	60	DQ20	102	VCC	144	DQ52
19	DQ14	61	NC	103	DQ46	145	NC
20	DQ15	62	NC	104	DQ47	146	NC
21	NC	63	NC	105	NC	147	NC
22	NC	64	VSS	106	NC	148	VSS

Table 20. System memory connector-pin assignments

Pin	Signal	Pin	Signal	Pin	Signal	Pin	Signal
23	VSS	65	DQ21	107	VSS	149	DQ53
24	NC	66	DQ22	108	NC	150	DQ54
25	NC	67	DQ23	109	NC	151	DQ55
26	VCC	68	VSS	110	VCC	152	VSS
27	/WE	69	DQ24	111	/CAS	153	DQ56
28	DQMB0	70	DQ25	112	DQMB4	154	DQ57
29	DQMB1	71	DQ26	113	DQMB5	155	DQ58
30	/S0	72	DQ27	114	NC	156	DQ59
31	DU	73	VCC	115	/RAS	157	VCC
32	VSS	74	DQ28	116	VSS	158	DQ60
33	A0	75	DQ29	117	A1	159	DQ61
34	A2	76	DQ30	118	A3	160	DQ62
35	A4	77	DQ31	119	A5	161	DQ63
36	A6	78	VSS	120	A7	162	VSS
37	A8	79	CK2	121	A9	163	CK3
38	A10/AP	80	NC	122	BA0	164	NC
39	NC	81	NC	123	NC	165	SA0
40	VCC	82	SDA	124	VCC	166	SA1
41	VCC	83	SCL	125	CK1	167	SA2
42	CK0	84	VCC	126	A12	168	VCC

Table 21. System memory connector pin input/output

Pin	Signal name	I/O	Pin	Signal name	I/O	Pin	Signal name	I/O
1	Ground	N/A	57	MD18	I/O	113	DQMB4#	I
2	MD0	I/O	58	MD19	I/O	114	S1#	I
3	MD1	I/O	59	VDD	N/A	115	RAS#	I
4	MD2	I/O	60	MD20	I/O	116	Ground	N/A
5	MD3	I/O	61	CKE1	N/A	117	A1	I
6	VDD	I/O	62	VREF	N/A	118	A3	I
7	MD4	I/O	63	(CKE1)*	N/A	119	A5	I
8	MD5	I/O	64	Ground	N/A	120	A7	I
9	MD6	I/O	65	MD21	I/O	121	A9	I
10	MD7	I/O	66	MD22	I/O	122	A11	I
11	MD8 (PAR0)	I/O	67	MD23	I/O	123	NC	
12	Ground	N/A	68	Ground	N/A	124	VDD	N/A
13	MD9	I/O	69	MD24	I/O	125	CK1	N/A
14	MD10	I/O	70	MD25	I/O	126	A14	O
15	MD11	I/O	71	MD26	I/O	127	Ground	N/A

Table 21. System memory connector pin input/output

Pin	Signal name	I/O	Pin	Signal name	I/O	Pin	Signal name	I/O
16	MD12	I/O	72	MD27	I/O	128	CKE0	N/A
17	MD13	I/O	73	VDD	N/A	129	S3#	I
18	VDD	N/A	74	MD28	I/O	130	DQMB6#	I
19	MD14	I/O	75	MD29	I/O	131	DQMB7#	I
20	MD15	I/O	76	MD30	I/O	132	A15	I
21	NC	I/O	77	MD31	I/O	133	VDD	N/A
22	NC	I/O	78	Ground	N/A	134	NC	N/A
23	Ground	I/O	79	CK2	O	135	NC	N/A
24	NC	N/A	80	NC	N/A	136	NC	N/A
25	NC	N/A	81	NC	O	137	NC	I/O
26	VDD	N/A	82	SDA	O	138	Ground	N/A
27	WE#	I	83	SCL	O	139	MD48	I/O
28	DQMB0#	I	84	VDD	N/A	140	MD49	I/O
29	DQMB1#	I	85	Ground	N/A	141	MD50	I/O
30	S0#	I	86	MD32	I/O	142	MD51	I/O
31	OE0#	I	87	MD33	I/O	143	VDD	N/A
32	Ground	N/A	88	MD34	I/O	144	MD52	I/O
33	A0	I	89	MD35	I/O	145	NC	N/A
34	A2	I	90	VDD	N/A	146	VREF	N/A
35	A4	I	91	MD36	N/A	147	NC	N/A
36	A6	I	92	MD37	I/O	148	Ground	N/A
37	A8	I	93	MD38	I/O	149	MD53	I/O
38	A10/AP	I	94	MD39	I/O	150	MD54	I/O
39	NC	BA1	95	MD40	I/O	151	MD55	I/O
40	VDD	N/A	96	Ground	N/A	152	Ground	N/A
41	NC	N/A	97	MD41	I/O	153	MD56	I/O
42	CK0	N/A	98	MD42	I/O	154	MD57	I/O
43	Ground	N/A	99	MD43	I/O	155	MD58	I/O
44	OE2#	I	100	MD44	I/O	156	MD59	I/O
45	S2#	I	101	MD45	I/O	157	VDD	N/A
46	DQMB2#	I	102	VDD	N/A	158	MD60	I/O
47	DQMB3#	I	103	MD46	I/O	159	MD61	I/O
48	WE2#	I	104	MD47	I/O	160	MD62	I/O
49	VDD	N/A	105	NC	I/O	161	MD63	I/O
50	NC	N/A	106	NC	I/O	162	Ground	N/A
51	NC	N/A	107	Ground	N/A	163	CK3	O
52	NC	I/O	108	NC	N/A	164	NC	N/A
53	NC	I/O	109	NC	N/A	165	SA0	O

Table 21. System memory connector pin input/output

Pin	Signal name	I/O	Pin	Signal name	I/O	Pin	Signal name	I/O
54	Ground	N/A	110	VDD	N/A	166	SA1	O
55	MD16	I/O	111	CAS#	N/A	167	SA0	O
56	MD17	I/O	112	DQMB4#	I	168	VDD	N/A

32-bit PCI connectors

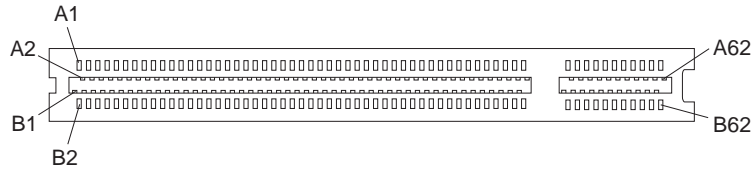

Table 22. PCI connector-pin assignments

Pin	Signal	I/O	Pin	Signal	I/O
A1	TRST#	O	B1	-12 V dc	
A2	+12 V dc		B2	TCK	O
A3	TMS	O	B3	Ground	
A4	TDI	O	B4	TDO	I
A5	+5 V dc		B5	+5 V dc	
A6	INTA#	I	B6	+5 V dc	
A7	INTC#	I	B7	INTB#	I
A8	+5 V dc		B8	INTD#	I
A9	Reserved		B9	PRSNT1#	I
A10	+5 V dc		B10	Reserved	
A11	Reserved		B11	PRSNT2#	I
A12	Ground		B12	Ground	
A13	Ground		B13	Ground	
A14	3.3 V AUX		B14	3.3 V AUX	
A15	RST#	O	B15	Ground	
A16	+5 V dc (I/O)		B16	CLK	O
A17	GNT#	O	B17	Ground	
A18	Ground		B18	REQ#	I
A19	PCI PME		B19	+5 V dc	
A20	Address/data 30	I/O	B20	Address/data 31	I/O
A21	+3.3 V dc		B21	Address/data 29	I/O
A22	Address/data 28	I/O	B22	Ground	
A23	Address/data 26	I/O	B23	Address/data 27	I/O
A24	Ground	I/O	B24	Address/data 25	

Table 22. PCI connector-pin assignments

Pin	Signal	I/O	Pin	Signal	I/O
A25	Address/data 24	I/O	B25	+3.3 V dc	
A26	IDSEL	O	B26	C/BE 3#	I/O
A27	+3.3 V dc		B27	Address/data 23	I/O
A28	Address/data 22	I/O	B28	Ground	
A29	Address/data 20	I/O	B29	Address/data 21	I/O
A30	Ground	I/O	B30	Address/data 19	
A31	Address/data 18	I/O	B31	+3.3 V dc	
A32	Address/data 16	I/O	B32	Address/data 17	I/O
A33	+3.3 V dc		B33	C/BE 2#	I/O
A34	FRAME#	I/O	B34	Ground	
A35	Ground		B35	IRDY#	I/O
A36	TRDY#	I/O	B36	+3.3 V dc	
A37	Ground		B37	DEVSEL#	I/O
A38	STOP#	I/O	B38	Ground	
A39	+3.3 V dc		B39	LOCK#	I/O
A40	SMBCLK1	I/O	B40	PERR#	I/O
A41	SMBDATA1	I/O	B41	+3.3 V dc	
A42	Ground		B42	SERR#	I/O
A43	PAR		B43	+3.3 V dc	
A44	Address/data 15	I/O	B44	C/BE 1#	I/O
A45	+3.3 V dc	I/O	B45	Address/data 14	I/O
A46	Address/data 13		B46	Ground	
A47	Address/data 11	I/O	B47	Address/data 12	I/O
A48	Ground	I/O	B48	Address/data 10	I/O
A49	Address/data 9		B49	Ground	
A50	Key		B50	Key	
A51	Key		B51	Key	
A52	C/BE(0)#	I/O	B52	Address/data 8	I/O
A53	+3.3 V dc	I/O	B53	Address/data 7	I/O
A54	Address/data 6		B54	+3.3 V dc	
A55	Address/data 4	I/O	B55	Address/data 5	I/O
A56	Ground	I/O	B56	Address/data 3	I/O
A57	Address/data 2		B57	Ground	
A58	Address/data 0	I/O	B58	Address/data 1	I/O
A59	+5 V dc		B59	+5 V dc	
A60	ACK64#	I/O	B60	ACK64#	I/O
A61	+5 V dc		B61	+5 V dc	
A62	+5 V dc		B62	+5 V dc	

32-bit PCI connector with integrated Ethernet extension

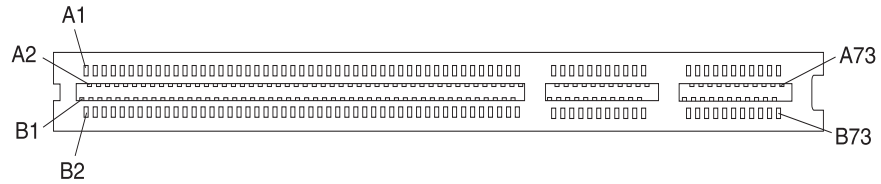

Table 23. 64-bit PCI connector-pin assignments

Pin	Signal	I/O	Pin	Signal	I/O
A1	TRST#	O	B1	-12 V dc	
A2	+12 V dc		B2	TCK	O
A3	TMS	O	B3	Ground	
A4	TDI	O	B4	TDO	I
A5	+5 V dc		B5	+5 V dc	
A6	INTA#	I	B6	+5 V dc	
A7	INTC#	I	B7	INTB#	I
A8	+5 V dc		B8	INTD#	I
A9	Reserved		B9	PRSENT1#	I
A10	+5 V dc		B10	Reserved	
A11	Reserved		B11	PRSENT2#	I
A12	Ground		B12	Ground	
A13	Ground		B13	Ground	
A14	3.3 V AUX		B14	3.3 V AUX	
A15	RST#	O	B15	Ground	
A16	+5 V dc (I/O)		B16	CLK	O
A17	GNT#	O	B17	Ground	
A18	Ground		B18	REQ#	I
A19	PCI		B19	+5 V dc	
A20	Address/data 30	I/O	B20	Address/data 31	I/O
A21	+3.3 V dc		B21	Address/data 29	I/O
A22	Address/data 28	I/O	B22	Ground	
A23	Address/data 26	I/O	B23	Address/data 27	I/O
A24	Ground	I/O	B24	Address/data 25	
A25	Address/data 24	I/O	B25	+3.3 V dc	
A26	IDSEL	O	B26	C/BE 3#	I/O
A27	+3.3 V dc		B27	Address/data 23	I/O
A28	Address/data 22	I/O	B28	Ground	
A29	Address/data 20	I/O	B29	Address/data 21	I/O
A30	Ground	I/O	B30	Address/data 19	

Table 23. 64-bit PCI connector-pin assignments

Pin	Signal	I/O	Pin	Signal	I/O
A31	Address/data 18	I/O	B31	+3.3 V dc	
A32	Address/data 16	I/O	B32	Address/data 17	I/O
A33	+3.3 V dc		B33	C/BE 2#	I/O
A34	FRAME#	I/O	B34	Ground	
A35	Ground		B35	IRDY#	I/O
A36	TRDY#	I/O	B36	+3.3 V dc	
A37	Ground		B37	DEVSEL#	I/O
A38	STOP#	I/O	B38	Ground	
A39	+3.3 V dc		B39	LOCK#	I/O
A40	SMBCLK1	I/O	B40	PERR#	I/O
A41	SMBDATA1	I/O	B41	+3.3 V dc	
A42	Ground		B42	SERR#	I/O
A43	PAR		B43	+3.3 V dc	
A44	Address/data 15	I/O	B44	C/BE 1#	I/O
A45	+3.3 V dc	I/O	B45	Address/data 14	I/O
A46	Address/data 13		B46	Ground	
A47	Address/data 11	I/O	B47	Address/data 12	I/O
A48	Ground	I/O	B48	Address/data 10	I/O
A49	Address/data 9		B49	Ground	
A50	Key		B50	Key	
A51	Key		B51	Key	
A52	C/BE(0)#	I/O	B52	Address/data 8	I/O
A53	+3.3 V dc	I/O	B53	Address/data 7	I/O
A54	Address/data 6		B54	+3.3 V dc	
A55	Address/data 4	I/O	B55	Address/data 5	I/O
A56	Ground	I/O	B56	Address/data 3	I/O
A57	Address/data 2		B57	Ground	
A58	Address/data 0	I/O	B58	Address/data 1	I/O
A59	+5 V dc		B59	+5 V dc	
A60	ACK64#	I/O	B60	ACK64#	I/O
A61	+5 V dc		B61	+5 V dc	
A62	+5 V dc		B62	+5 V dc	
A63	TXD0		B63	RXD0	
A64	TXD1		B64	RXC1	
A65	TXD2		B65	RXD2	
A66	LAN_CLK	I/O	B66	LAN_RSTSYNC	
A67	Ground		B67	Ground	
A68	EE_DOUT		B68	EE_SHCLK	

Table 23. 64-bit PCI connector-pin assignments

Pin	Signal	I/O	Pin	Signal	I/O
A69	EE_DIN		B69	EE_CS	
A70	NC		B70	NC	I/O
A71	NC		B71	NC	
A72	NC		B72	NC	
A73	NC		B73	NC	

Power supply connectors

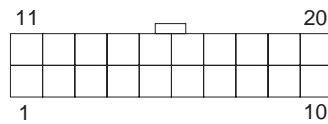

Table 24. Power supply (P1) connector-pin assignments

Pin	Signal name	Pin	Signal name
1	+3.3 V dc	11	+3.3 V dc
2	+3.3 V dc	12	-12 V dc
3	Ground	13	Ground
4	+ 5 V dc	14	On/Off
5	Ground	15	Ground
6	+5 V dc	16	Ground
7	Ground	17	Ground
8	PWR GOOD	18	-5 V dc (not used in A40 and A40p)
9	+5 V dc standby	19	+5 V dc
10	+12 V dc	20	+5 V dc

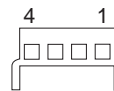

Table 25. Diskette drive power supply (P3) connector-pin assignments

Pin	Signal name	Pin	Signal name
1	+5 v dc	3	Ground
2	Ground	4	+12 v dc

Table 26. IDE device power supply (P5, P6, P7, P8, P9, P10, P11, P12) connector-pin assignments

Pin	Signal name	Pin	Signal name
1	+12 v dc	3	Ground
2	Ground	4	+5 v dc

Wake on LAN connector

Table 27. Wake on LAN connector-pin assignments

Pin	Description
1	+5 V dc standby
2	Ground
3	Wake on LAN

Tamper detection switch

Table 28. Tamper detection switch pin assignments

Pin	Description
1	Tamper switch
2	Ground

RFID

Table 29. RFID pin assignments

Pin	Description
1	RFID Ant 1
2	Key
3	Ground
4	RFID Ant 2

CD audio connector

Table 30. CD audio connector-pin assignments

Pin	Description
1	CD-in Left
2	CD-in Ground
3	CD-in Ground
4	CD-in Right

SCSI LED connectors

Table 31. SCSI LED connector-pin assignments

Pin	Description
1	Not connected
2	to LED
3	to LED
4	Not connected

Appendix B. System address maps

The following charts represent how the hard disk stores different types of information. Address ranges and byte sizes are approximate.

System memory map

The first 640 KB of system board RAM is mapped starting at address hex 00000000. A 256 byte area and a 1 KB area of this RAM are reserved for BIOS data. Memory can be mapped differently if POST detects an error.

Table 32. System memory map

Address range (decimal)	Address range (hex)	Size	Description
0 K – 512 KB	00000 – 7FFFF	512 KB	Conventional
512 K – 639 KB	80000 – 9FBFF	127 KB	Extended conventional
639 K – 640 KB	9FC00 – 9FFFF	1 KB	Extended BIOS data
640 K – 767 KB	A0000 – BFFFF	128 KB	Dynamic video memory display cache
768 K – 800 KB	C0000 – C7FFF	32 KB	Video ROM BIOS (shadowed)
800 K – 896 KB	C8000 – DFFFF	96 KB	PCI space, available to adapter ROMs
896 K – 1 MB	E0000 – FFFFF	128 KB	System ROM BIOS (main memory shadowed)
1 MB – 16 MB	1000000 – FFFFFFF	15 MB	PCI space
16 MB – 4096 MB	10000000 – FFDFFFFFF	4080 MB	PCI space (positive decode)
	FFFE0000 – FFFFFFFF	128 KB	System ROM BIOS

I/O address map

The following figure lists resource assignments for the I/O address map. Any addresses that are not shown are reserved.

Table 33. I/O address map

Address (hex)	Size (bytes)	Description
0000 – 000F	16	DMA 1
0010 – 001F	16	General I/O locations, available to PCI bus
0020 – 0021	2	Interrupt controller 1
0022 – 003F	30	General I/O locations, available to PCI bus
0040 – 0043	4	Counter/timer 1
0044 – 00FF	28	General I/O locations, available to PCI bus
0060	1	Keyboard controller byte, reset IRQ
0061	1	System port B
0064	1	Keyboard controller, CMD/ATAT byte
0070, bit 7	1 bit	Enable NMI

Table 33. I/O address map

Address (hex)	Size (bytes)	Description
0070, bits 6:0	6 bits	Real-time clock, address
0071	1 byte	Real-time clock, data
0072	1 bit	Enable NMI
0072, bits 6:0	6 bits	RTC address
0073	1 byte	RTC data
0080	1	POST checkpoint register during POST only
008F	1	Refresh page register
0080 – 008F	16	DMA page registers
0090 – 0091	15	General I/O locations, available to PCI bus
0092	1	PS/2 keyboard controller registers
0093 – 009F	15	General I/O locations
00A0 – 00A1	2	Interrupt controller 2
00A2 – 00BF	30	APM control
00C0 – 00DF	31	DMA 2
00E0 – 00EF	16	General I/O locations, available to PCI bus
00F0	1	Coprocessor Error register
00F1 – 016F	127	General I/O locations, available to PCI bus
0170 – 0177	8	Secondary IDE channel
01F0 – 01F7	8	Primary IDE channel
0200 – 0207	8	MIDI/joystick port
0220 – 0227	8	Serial port 3 or 4
0228 – 0277	80	General I/O locations, available to PCI bus
0278 – 027F	8	LPT3
0280 – 02E7	102	Available
02E8 – 02EF	8	Serial port 3 or 4
02F8 – 02FF	8	COM2
0338 – 033F	8	Serial port 3 or 4
0340 – 036F	48	Available
0370 – 0371	2	IDE channel 1 command
0378 – 037F	8	LPT2
0380 – 03B3	52	Available
03B4 – 03B7	4	Video
03BA	1	Video
03BC – 03BE	16	LPT1
03C0 – 03CF	52	Video
03D4 – 03D7	16	Video
03DA	1	Video
03D0 – 03DF	11	Available

Table 33. I/O address map

Address (hex)	Size (bytes)	Description
03E0 – 03E7	8	Available
03E8 – 03EF	8	COM3 or COM4
03F0 – 03F5	6	Diskette channel 1
03F6	1	Primary IDE channel command port
03F7 (Write)	1	Diskette channel 1 command
03F7, bit 7	1 bit	Diskette disk change channel
03F7, bits 6:0	7 bits	Primary IDE channel status port
03F8 – 03FF	8	COM1
0400 – 047F	128	Available
0480 – 048F	16	DMA channel high page registers
0490 – 0CF7	1912	Available
0CF8 – 0CFB	4	PCI configuration address register
0CFC – 0CFF	4	PCI configuration data register
LPTn + 400h	8	ECP port, LPTn base address + hex 400
OCF9	1	Turbo and reset control register
0D00 – FFFF	62207	Available

DMA I/O address map

The following figure lists resource assignments for the DMA address map. Any addresses that are not shown are reserved.

Table 34. DMA I/O address map

Address (hex)	Description	Bits	Byte pointer
0000	Channel 0, memory address register	00 – 15	Yes
0001	Channel 0, transfer count register	00 – 15	Yes
0002	Channel 1, memory address register	00 – 15	Yes
0003	Channel 1, transfer count register	00 – 15	Yes
0004	Channel 2, memory address register	00 – 15	Yes
0005	Channel 2, transfer count register	00 – 15	Yes
0006	Channel 3, memory address register	00 – 15	Yes
0007	Channel 3, transfer count register	00 – 15	Yes
0008	Channels 0–3, read status/write command register	00 – 07	
0009	Channels 0–3, write request register	00 – 02	
000A	Channels 0–3, write single mas register bits	00 – 02	
000B	Channels 0–3, mode register (write)	00 – 07	
000C	Channels 0–3, clear byte pointer (write)	A	
000D	Channels 0–3, master clear (write)/temp (read)	00 – 07	

Table 34. DMA I/O address map

Address (hex)	Description	Bits	Byte pointer
000E	Channels 0-3, clear mask register (write)	00 – 03	
000F	Channels 0-3, write all mask register bits	00 – 03	
0081	Channel 2, page table address register	00 – 07	
0082	Channel 3, page table address register	00 – 07	
0083	Channel 1, page table address register	00 – 07	
0087	Channel 0, page table address register	00 – 07	
0089	Channel 6, page table address register	00 – 07	
008A	Channel 7, page table address register	00 – 07	
008B	Channel 5, page table address register	00 – 07	
008F	Channel 4, page table address/refresh register	00 – 07	
00C0	Channel 4, memory address register	00 – 15	Yes
00C2	Channel 4, transfer count register	00 – 15	Yes
00C4	Channel 5, memory address register	00 – 15	Yes
00C6	Channel 5, transfer count register	00 – 15	Yes
00C8	Channel 6, memory address register	00 – 15	Yes
00CA	Channel 6, transfer count register	00 – 15	Yes
00CC	Channel 7, memory address register	00 – 15	Yes
00CE	Channel 7, transfer count register	00 – 15	Yes
00D0	Channels 4–7, read status/write command register	00 – 07	
00D2	Channels 4–7, write request register	00 – 02	
00D4	Channels 4–7, write single mask register bit	00 – 02	
00D6	Channels 4–7, mode register (write)	00 – 07	
00D8	Channels 4–7, clear byte pointer (write)		
00DA	Channels 4–7, master clear (write)/temp (read)	00 – 07	
00DC	Channels 4–7, clear mask register (write)	00 – 03	
00DE	Channels 4–7, write all mask register bits	00 – 03	
00DF	Channels 5–7, 8- or 16-bit mode select	00 – 07	

Appendix C. IRQ and DMA channel assignments

The following figures list the IRQ and DMA channel assignments.

Table 35. IRQ channel assignments

IRQ	System resource
NMI	Critical system error
SMI	System-management interrupt for power management
0	Timer
1	Keyboard
2	Cascade interrupt from slave PIC
3	COM2 (some models only)
4	COM1
5	LPT2/audio (if present)
6	Diskette controller
7	LPT1
8	Real-time clock
9	Video, ACPI
10	MIDI/joystick (A20 models only)
11	Available to user
12	Mouse port
13	Math coprocessor
14	Primary IDE (if present)
15	Secondary IDE (if present)

Note: The default settings for COM 1 (IRQ 4), COM 2 (IRQ 3), and LPT 1 (IRQ 7) can be changed to another IRQ.

Table 36. DMA channel assignments

DMA channel	Data width	System resource
0	8 bits	Open
1	8 bits	Open
2	8 bits	Diskette drive
3	8 bits	Parallel port (for ECP or EPP)
4		Reserved (cascade channel)
5	16 bits	Open
6	16 bits	Open
7	16 bits	Open

Appendix D. Error codes

The *NetVista User Guide* and the *Hardware Maintenance Manual* provide complete lists of error and beep codes.

POST error codes

POST error messages appear when, during startup, POST finds problems with the hardware or a change in the hardware configuration. POST error messages are 3-, 4-, 5-, 8-, or 12-character alphanumeric messages.

Beep codes

Beep codes are a series of tones in sets of two or three that sound when there are POST errors. The beep pattern represents numeric values and provide further information about the location of a potential problem.

Appendix E. Notices and trademarks

This appendix contains legal notices and trademark information.

Notices

This information was developed for products and services offered in the U.S.A.

IBM may not offer the products, services, or features discussed in this document in other countries. Consult your IBM representative for information on the products and services currently available in your area. Any reference to an IBM product, program, or service is not intended to state or imply that only that IBM product, program, or service may be used. Any functionally equivalent product, program, or service that does not infringe any IBM intellectual property right may be used instead. However, it is the user's responsibility to evaluate and verify the operation of any non-IBM product, program, or service.

IBM may have patents or pending patent applications covering subject matter described in this document. The furnishing of this document does not give you any license to these patents. You can send license inquiries, in writing, to:

IBM Director of Licensing
IBM Corporation
North Castle Drive
Armonk, NY10504-1785, U.S.A.

The following paragraph does not apply to the United Kingdom or any country where such provisions are inconsistent with local law: INTERNATIONAL BUSINESS MACHINES CORPORATION PROVIDES THIS PUBLICATION "AS IS" WITHOUT WARRANTY OF ANY KIND, EITHER EXPRESS OR IMPLIED, INCLUDING, BUT NOT LIMITED TO, THE IMPLIED WARRANTIES OF NON-INFRINGEMENT, MERCHANTABILITY OR FITNESS FOR A PARTICULAR PURPOSE. Some states do not allow disclaimer of express or implied warranties in certain transactions, therefore, this statement may not apply to you.

This publication could include technical inaccuracies or typographical errors. Changes are periodically made to the information herein; these changes will be incorporated in new editions of the publication. IBM may make improvements and/or changes in the product(s) and/or the program(s) described in this publication at any time without notice.

Any references in this publication to non-IBM Web sites are provided for convenience only and do not in any manner serve as an endorsement of those Web sites. The materials at those Web sites are not part of the materials for this product and use of those Web sites is at your own risk.

IBM may use or distribute any of the information you supply in any way it believes appropriate without incurring any obligation to you.

Any performance data contained herein was determined in a controlled environment. Therefore, the results obtained in other operating environments may vary significantly. Some measurements may have been made on development-level systems and there is no guarantee that these measurements will be the same on generally available systems. Furthermore, some measurements may have been estimated through extrapolation. Actual results may vary. Users of this document should verify the applicable data for their specific environment.

Trademarks

The following terms are trademarks of the IBM Corporation in the United States or other countries or both:

- IBM
- NetVista
- Wake on LAN

Intel, Pentium, Celeron, and MMX are trademarks of Intel Corporation in the United States, other countries, or both.

Microsoft, Windows, and Windows NT are trademarks of Microsoft Corporation in the United States, other countries, or both.

Other company, product, and service names may be trademarks or service marks of others.

Bibliography

Advanced Power Management (APM) BIOS Interface Specification

Source: Intel Corporation

AT Attachment Interface with Extensions

Source: Intel Corporation

Extended Capabilities Port Specification Kit

Source: Microsoft Corporation

Intel Microprocessor and Peripheral Components Literature

Source: PCI Special Interest Group

Plug and Play BIOS Specification

Source: Microsoft Corporation

available at <http://www.microsoft.com/hwdev>

Universal Serial Bus Specifications

Source: <http://www.usb.org>

Video Electronics Standards Association

Source: <http://www.vesa.org>

AT24RF08A- PCID Specification

Index

A

- accelerated graphics port (AGP) 1, 10, 11
- address map
 - DMA input/output (I/O) 47
 - input/output (I/O) 45
 - system 45
 - system memory 45
- Advanced Power Management (APM) 26
- asset security 1
- audio
 - controller 1, 11
 - device drivers 11
 - subsystem 11

B

- beep codes 51
- BIOS 25
- bus
 - IDE 7
 - low pin-count 9
 - PCI 7

C

- CD audio connector 42
- Celeron 1
- channel assignments
 - DMA 49
 - IRQ 49
- chip set 6, 7
- clock, real-time 12
- CMOS RAM 12
- compatibility
 - hardware 27
 - system 27
- component
 - output 22
- Configuration/Setup Utility program 26
- connector
 - 32-bit PCI pin assignments 37, 39
 - cable 13
 - CD audio pin assignments 42
 - diskette drive pin assignments 32
 - Ethernet pin assignments 31
 - IDE LED pin assignments 43
 - IDE pin assignments 33
 - internal device 23
 - internal drive 32
 - keyboard pin assignments 30
 - memory pin assignments 34
 - MIDI/joystick pin assignments 32
 - monitor pin assignments 29
 - mouse pin assignments 30
 - power supply pin assignments 41

- SCSI LED pin assignments 43
- serial pin assignments 30
- Universal Serial Bus (USB) pin assignments 29
- Wake on LAN pin assignments 42

controller

- audio 11
- hard disk drive 28
- parallel port 9
- serial port 8

D

- diagnostic program 26
- diskette drive
 - connector pin assignments 32
 - interface 8
 - subsystem 8
- DMA channel assignments 49
- DMA I/O address map 47

E

- electrically erasable programmable read-only memory (EEPROM) 26
- Enhanced Diagnostics 26
- environment, operating 17, 18, 19
- error codes, POST 51
- Ethernet
 - connector 13
 - connector pin assignments 31
 - subsystem 1
- expansion adapters 12

F

- fault
 - overvoltage 22
- features
 - general 1
 - microprocessor 5
 - video 10, 11
 - Wake on LAN 2
- flash update utility program 26
- frequency, input power 21

H

- hard disk drive
 - compatibility 28
 - controller 28
- hardware
 - compatibility 27
 - interrupts 27
- Hardware Maintenance Manual vii

I

- IDE
 - bus master 1, 7
 - CD-ROM 1
 - connector pin assignments 33
 - interface 7
- input power
 - frequency 21
 - requirements 21
 - voltage 21
- input/output (I/O)
 - address map 45, 47, 48
 - controller 8
 - diskette drive 8
 - DMA address map 47, 48
 - keyboard 9
 - mouse 9
 - parallel port 9
 - serial port 8
- interrupt request (IRQ) channel assignments 49
- interrupts
 - hardware 27
 - level-sensitive 27

K

- keyboard
 - connector pin assignments 30
 - port 9

L

- layout
 - physical 3
 - system board 3
- LED connectors
 - SCSI pin assignments 43
- low pin-count bus 9

M

- machine-sensitive programs 28
- memory
 - connector pin assignments 34
 - map 45
 - subsystem 6
 - synchronous dynamic random access memory (SDRAM) 6
 - system 1
 - video 10
- messages, POST error 51
- microprocessor
 - Celeron 1, 5
 - Pentium III 1, 5
- MIDI/joystick connector pin assignments 32
- modes, power management 26
- monitor

- connector pin assignments 29
- suppor 11
- mouse
 - connector pin assignments 30
 - port 9

N

- NetVista User Guide vii
- network
 - support 2, 12
- noise level 17, 18, 19

O

- ordering publications vii
- output
 - power supply 21
 - protection 22
- overvoltage fault 22

P

- parallel
 - connector pin assignments 31
 - port 9
 - assignments 9
 - enhanced parallel port (EPP) 9
 - standard parallel port (SPP) 9
- PCI
 - bus 7
 - connector pin assignments
 - 32-bit 37, 39
- Pentium III Xeon 5
- physical layout 3, 4
- pin assignments
 - Ethernet connector 31
 - radio frequency identification (RFID) 42
 - tamper detection switch 42
- Plug and Play 25
- port
 - assignments 9
 - Ethernet 12
 - keyboard 9
 - mouse 9
 - parallel 9
 - serial 8
- POST 51
 - code 25
 - initialization code 25
- power
 - consumption 26
 - for components 22
 - input 21
 - internal device 23
 - load current 21
 - management modes 26
 - output 21
 - output protection 22

- supply 21
- supply connector pin assignments 42

Q

- Quick Reference vii

R

- real-time clock 12
- related publications vii

S

SCSI

- LED connector pin assignments 43
- serial connector pin assignments 30
- short circuit 22
- software
 - BIOS 25
 - Configuration/Setup Utility program 26
 - diagnostic program 26
 - flash update utility program 26
 - system 25
- specifications 17
- super input/output controller 8
- system
 - compatibility 27
 - management 1
 - memory 1, 6
 - memory map 45
 - software 25
- system address maps 45
- system board
 - features 3, 4
 - layout 3, 4

T

- tamper detection switch pin assignments 42
- terminology vii
- trademarks 53

U

- Understanding Your Personal Computer vii
- Universal Serial Bus (USB)
 - connector pin assignments 29

V

- video
 - features 10, 11
 - subsystem 10
- voltage

- input power 21
- output power 21

W

- Wake on LAN
 - connector pin assignments 42
 - features 2



Part Number:



Printed in the United States of America
on recycled paper containing 10%
recovered post-consumer fiber.

