



Compaq Microcom 4000 Cabling & Setup White Paper

This document outlines the cabling required for the Compaq Microcom 4000's individual modem serial DTE interfaces and the management port through different examples and outlines Compaq's recommended Compaq Microcom 4000 modem initialization strings.

Quick Reference Guide

Vendor/Product	Comm Server Connector	Diagram	Compaq	
			Cable Kit	RJ-45 Cable Length
Livingston Portmaster	DB-25f	2A	178697-B21	6'
3Com Access Builder	DB-25f	13A	178697-B21	6'
3Com Access Builder	RJ-45f	14		
Shiva LanRover	DB-9m	3A	178698-B21	6'
Digiboard	DB-25m	5A	178699-B21	6'
Digiboard	RJ-45f	8		
Computone PowerRack	RJ-45f	4	178709-B21	6'
Computone Intelliporte	RJ-45f	4A		6'
Cisco 2511	RJ-45m	6	178706-B21	4'
Cyclades Serial Board	DB-25m	5A		
Cyclades Cyclom-Y	RJ-45/10pin	20		
Cyclades Cyclom-Z	RJ-45f	21		
Cyclades PathRAS	RJ-45f	22		
DECserver 90M	RJ-45f	7	178708-B21	6'
DECserver 700-08	DB-25m	5A	178699-B21	6'
DECserver 700-16, 900TM	RJ-45f	7	178708-B21	6'
DECserver 900GM, 900GMx	RJ-45m	7	178708-B21	6'
Equinox	RJ-45f	19		
PC with a DB-9 male port	DB-9m	3A	178698-B21	6'
PC with a DB-25 male port	DB-25m	5A	178699-B21	6'
Comtrol RocketPort	RJ-45f	10		
Comtrol RocketPort	DB-25m	11A		
Comtrol RocketPort	DB-9m	12A		
Comtrol VS1000/1100	RJ-45f	10		
Bay Networks 5390	RJ-45f	15		
Xyplex	RJ-45f	9	178707-B21	6'
Modem to Mgmt Port *		17A	380017-B21	6'

Note: Each Compaq cable kit contains cables, couplers if applicable, and adapters for four ports (except where marked with *).

Data Set Ready / Ring Indicator

Some applications require Data Set Ready (DSR) while others require the Ring Indicator (RI) signal. Through an AT command, Compaq gives you the flexibility to assign either DSR or RI to pin 1 on the RJ-45 depending

Compaq Microcom 4000 Cabling and Setup White Paper on your application. DSR is useful in some mainframe, minicomputer, and remote access server (RAS) environments.

The AT commands and descriptions are as follows:

- \R0 Ring Indicator signal ON for the duration of the telephone call
- \R1 Ring Indicator signal ON until the telephone call is answered
- \R2 DSR output on pin 1 of the RJ-45 instead of RI

When the \R0 or \R1 is set, and when the modem receives an incoming call, the RI signal tracks the ring signal on the telephone line.

When \R2 is set, the RI signal is used as a DSR (Data Set Ready) signal, based on the &C and \D settings. This option is for systems that require DSR to be present when establishing a connection. The RI signal is seen on pin 1 of the RJ-45 serial adapter. To have the DSR signal seen on pin 1, use the \R2 setting.

Modem Initialization

Compaq recommends the Compaq Microcom 4000 be set to 115200, 8N1, hardware flow control with the following initialization string for dial in applications (answer only) except where otherwise noted:

```
AT&F%U1$B115200Q1E0-O4*W
```

For dial out applications, Compaq recommends you modify the above string by replacing the "Q1" with "Q2".

Windows NT 3.51 RAS

When using the Compaq Microcom 4000 in a Windows NT 3.51 RAS environment, download the following:

```
ftp://ftp.microcom.com/pubs/4000_series/scripts/modem3.exe
```

Rename the existing modem.inf file in the \system directory and replace it with this version.

Windows NT 4.0 RAS

When using the Compaq Microcom 4000 in a Windows NT 4.0 RAS environment, download the following:

```
ftp://ftp.microcom.com/pubs/4000_series/scripts/cm4knt40.exe
```

In the Control Panel select modems. Click on 'Add Modem'. Click on 'Have Disk' and point to cm4knt40.exe.

Connecting to the Serial DTE Interface

The Compaq Microcom 4000 utilizes an RJ-45 female connector on the analog adapter for each of the individual modems. The following are examples of how to cable the Compaq Microcom 4000's DTE interface.

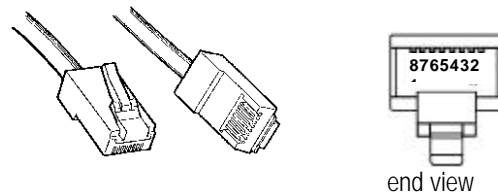

Diagram 1: Standard RJ-45 male connector and pin number location - For RJ-45 male to RJ-45 male cables, refer to Compaq Part # 178709-B21 (Set of 4)

Connecting to a DB-25 Female Port

If your comm server has a DB-25 female connector, use this RJ-45 (female) to DB-25 (male) serial DTE adapter.

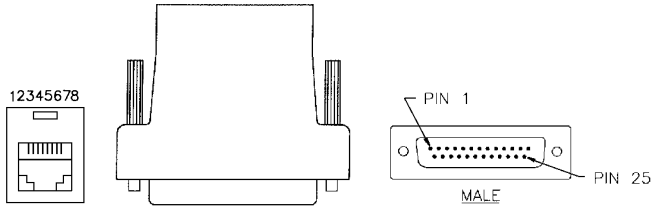

Diagram 2: RJ-45 (female) to DB-25 (male) Adapter - Compaq Part Number 178697-B21 (Set of 4)

RJ-45	DB-25	Function	Abbrev.
—	1	Shield	—
6	2	Transmitted Data	TXD
5	3	Received Data	RXD
8	4	Request To Send	RTS
7	5	Clear To Send	CTS
—	6	Data Set Ready	DSR
4	7	Signal Ground	—
2	8	Carrier Detect	DCD
—	15	Transmit Clock	—
—	17	Receive Clock	—
—	18	Local Loopback	LL
3	20	Data Terminal Ready	DTR
—	21	Remote Loopback	RL
1	22	Ring Indicator	RI
—	24	External Clock	EXCK
—	25	Test Indicator/Mode	—

Table 1: Pinouts for the RJ-45 (female) to DB-25 (male) Adapter

Livingston PortMaster: A Livingston PortMaster 10, PortMaster 2E and PortMaster 25, requires an 8 wire male RJ-45 to RJ-45 straight through cable of the appropriate length.

PortMaster Configuration: Full modem control should be on RTS/CTS flow control (hardware flow control). Compaq recommends using Compaq Microcom 4000 factory settings.

3Com Access Builder: Use this adapter to connect to the back of the Access Builder. Use a straight through RJ-45 male cable from the RJ-45 end of the Compaq adapter to the Compaq Microcom 4000.

Connecting to a DB-9 Male Port

One RJ-45 male to RJ-45 male cable and RJ-45 to DB-9 adapter is required for each modem connection to the Compaq Microcom 4000.

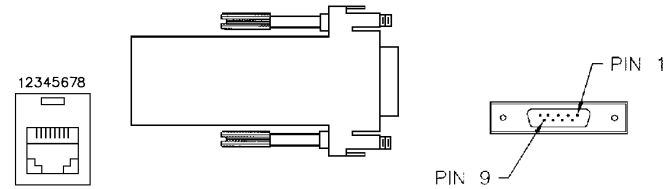

Diagram 3: RJ-45 (female) to DB-9 (female) Adapter - Compaq Part Number 178698-B21 (Set of 4)

RJ-45	DB-9	Function	Abbrev.
2	1	Carrier Detect	DCD
5	2	Received Data	RXD
6	3	Transmitted Data	TXD
3	4	Data Terminal Ready	DTR
4	5	Signal Ground	—
—	6	Data Set Ready	DSR
8	7	Request To Send	RTS
7	8	Clear To Send	CTS
1	9	Ring Indicator	RI

Table 2: Pinouts for the RJ-45 (female) to DB-9 (female) Adapter

A standard PC DB-9 port: Connect to a standard PC by using a standard 8-pin RJ-45 male to RJ-45 male cable to connect to each analog port on the back of the Compaq Microcom 4000 chassis. See Diagram 1.

Connect the other male end of the RJ-45 cable to a DB-9 female adapter, diagram 3A, which is then connected to the back of your PC.

Shiva LanRover: Use Compaq's RJ-45 female to DB-9 female adapter to connect to the DB-9 port on the LanRover. A straight through RJ-45 male to RJ-45 male cable connects the adapter to the Compaq Microcom 4000.

Connecting to a Computone PowerRack

RJ-45 (male) to RJ-45 (male) Cable Pinouts - (See Diagram 1)

Compaq 8-pin RJ-45	Computone 10-pin RJ-45	Function	Abbrev.
—	1	Chassis Ground	CG
1	2	Ring Indicator	RI
2	3	Carrier Detect	DCD
3	4	Data Terminal Ready	DTR
4	5	Signal Ground	—
5	6	Received Data	RXD
6	7	Transmitted Data	TXD
7	8	Clear To Send	CTS
8	9	Request To Send	RTS
—	10	Data Set Ready	DSR

Table 3: Pinouts for a standard 8-pin RJ-45 connector and a Computone 10-pin RJ-45 connector

The following configurations require the use of an RJ-45 male to RJ-45 straight through male cable - Compaq Part Number 178709-B21 (Set of 4):

Computone PowerRack: To connect the 8 pin RJ-45 female on the Compaq Microcom 4000 to the 10 pin RJ-45 female on the PowerRack, an RJ-45 male to male cable is required. One cable is required per PowerRack port connected to the Compaq Microcom 4000. The above pinout assumes an 8 pin RJ-45 connector on one end and a 10 pin RJ-45 on the other end, though an 8 pin straight through cable with 8 pin connectors on both ends will work.

Connecting to a Computone Intelliporte II EX

RJ-45 (male) to RJ-45 (male) Cable Pinouts - (See Diagram 1)

Compaq 8-pin RJ-45	Computone 8-pin RJ-45	Function	Abbrev.
—	8	Chassis Ground	CG
1	—	Ring Indicator	RI
2	5	Carrier Detect	DCD
3	2	Data Terminal Ready	DTR
4	4	Signal Ground	—
5	6	Received Data	RXD
6	3	Transmitted Data	TXD
7	1	Clear To Send	CTS
8	7	Request To Send	RTS

Table 4: Pinouts for a Computone Intelliporte II EX Cable

Computone Intelliporte II EX: To connect the 8 pin RJ-45 female on the Compaq Microcom 4000 to the 8 pin RJ-45 female on the Intelliporte II EX, an RJ-45 male to male cable is required. One cable is required per Intelliporte II EX port connected to the Compaq Microcom 4000.

Connecting to a DB-25 Male Port

If your comm server or PC has a DB-25 male connector, use this RJ-45 (female) to DB-25 (female) serial DTE adapter.

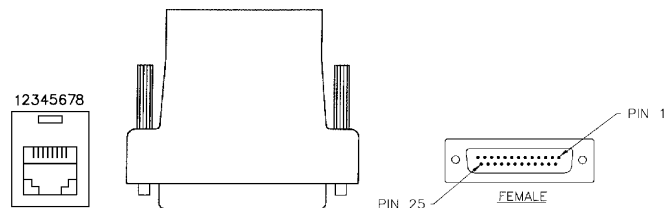

Diagram 4: RJ-45 (female) to DB-25 (female) Adapter- Compaq Part Number 178699-B21 (Set of 4)

RJ-45	DB-25	Function	Abbrev.
—	1	Shield	—
6	2	Transmitted Data	TXD
5	3	Received Data	RXD
8	4	Request To Send	RTS
7	5	Clear To Send	CTS
—	6	Data Set Ready	DSR
4	7	Signal Ground	—
2	8	Carrier Detect	DCD
—	15	Transmit Clock	—
—	17	Receive Clock	—
—	18	Local Loopback	LL
3	20	Data Terminal Ready	DTR
—	21	Remote Loopback	RL
1	22	Ring Indicator	RI
—	24	External Clock	EXCK
—	25	Test Indicator/Mode	—

Table 5: Pinouts for the RJ-45 (female) to DB-25 (female) Adapter

Digiboard: When connecting the Compaq Microcom 4000 female RJ-45 serial DTE connectors with a Digiboard with male DB-25 connectors, a straight through RJ-45 male to RJ-45 male cable of appropriate length is required for use with the adapter.

DECServer 700-08: Once this adapter is connected to the DB-25 male port on this DECServer, a straight through RJ-45 male to RJ-45 male cable will complete the connection to the Compaq Microcom 4000.

A new version of Access Server Manager supporting the Compaq Microcom 4000 may be required. It may be downloaded from:

<http://www.networks.digital.com/dr/hubs/servers/software/servr-mn.html>

DECServer 700-08 initialization string:

AT&FQ2V1&C1&D3%U1\$B115200\Q3\D3S0=1&W

LANexpress: A straight through RJ-45 male to RJ-45 male cable connects the RJ-45 female to DB-25 female adapter to the Compaq Microcom 4000.

A standard PC with a DB-25 male port: Connect to a standard PC by using a standard 8-pin RJ-45 male to RJ-45 male cable to connect to each analog port on the back of the Compaq Microcom 4000 chassis. See Diagram 1

Connect the other male end of the RJ-45 cable to a DB-25 female adapter (see Table 5), which is then connected to the back of your PC.

Connecting to the Cisco 2500 Series

A Cisco specific RJ-45 to RJ-45 twisted cable is required - Compaq Part Number 178706-B21 (Set of 4, includes couplers)

To connect to the RJ-45 male connectors on this model, use the RJ-45 female to RJ-45 female couplers provided with the cable kit. When connecting the RJ-45 twisted cable to the coupler, make sure that the RJ-45 cable end labeled "Cisco 2511" is inserted into the coupler. The other end is then connected to the Compaq Microcom 4000.

Cisco RJ-45	Compaq Microcom 4000 RJ-45 (Pin 1 not used)	Function	Abbrev.
1	7	Clear To Send	CTS
2	2	Carrier Detect	DCD
3	5	Received Data	RXD
4 & 5	4	Signal Ground	—
6	6	Transmitted Data	TXD
7	3	Data Terminal Ready	DTR
8	8	Request To Send	RTS

Table 6: Pinouts for a Cisco 2500 Series RJ-45 Cable

Compaq recommends the following string be used with the Compaq Microcom 4000 when connecting to a Cisco 2500 Series communication server:

AT&F\$B115200%U1-O4S2=0-H1*W

Connecting to the DECServer 90M, 700-16, 900TM, 900GM and the 900GMx

These DECServers require a DIGITAL specific RJ-45 to RJ-45 twisted cable, Compaq Part Number 178708-B21 (Set of 4, includes couplers)

DIGITAL RJ-45	Compaq Microcom 4000 RJ-45 (Pin 1 not used)	Function	Abbrev.
1 & 3	4	Signal Ground	—
2	5	Received Data	RXD
4	7	Clear To Send	CTS
5	8	Request to Send	RTS
6	6	Transmitted Data	TXD
7	3	Data Terminal Ready	DTR
8	2	Carrier Detect	DCD

Table 7: Pinouts for a DIGITAL specific RJ-45 Cable

Access Server Manager: A new version of Access Server Manager supporting the Compaq Microcom 4000 may be required. It may be downloaded from:

<http://www.networks.digital.com/dr/hubs/servers/software/serve-mn.html>

DECServer 90M initialization string:

AT&FQ2V1&C1&D3%U1\$B57600\Q1\D3S0=1&W

DECServer 90M: To connect to the RJ-45 female port, make sure that the RJ-45 cable end labeled "DECServer" is inserted into the DECServer. The unlabeled end connects to the Compaq Microcom 4000. A coupler is not required.

Note: The DECServer 90M does not support Request To Send and Clear To Send. Speed runs at a maximum of 57.6 Kbps XON/XOFF flow control.

DECserver 900TM, 900GM and the 700-16 initialization string:

AT&FQ2V1&C1&D3%U1\$B115200\Q3\D3S0=1&W

DECServer 700-16, 900TM: To connect to the RJ-45 female port on these DECServers, make sure that the RJ-45 cable end labeled "DECServer" is inserted into the DECServer. The unlabeled end connects to the Compaq Microcom 4000. A coupler is not required.

DECServer 900GM, 900GMx: To connect to the RJ-45 male connectors on these models, use the RJ-45 female to RJ-45 female couplers provided with the cable kit. When connecting the RJ-45 twisted cable to the coupler, make sure that the RJ-45 cable end labeled "DECServer" is inserted into the coupler. The other end is then connected to the Compaq Microcom 4000.

Connecting to the Digiboard RJ-45

RJ-45 (male) to RJ-45 (male) Cable Pinouts - (See Diagram 1)

Compaq 8-pin RJ-45	Digiboard 10-pin RJ-45	Function	Abbrev.
1	2	Data Set Ready	DSR
2	10	Carrier Detect	DCD
3	9	Data Terminal Ready	DTR
4	7	Signal Ground	—
5	6	Received Data	RXD
6	5	Transmitted Data	TXD
7	8	Clear To Send	CTS
8	3	Request To Send	RTS
		Ring Indicator	RI

Table 8: Pinouts for a Compaq Microcom 4000 8-pin RJ-45 Connector and a Digiboard 10-pin RJ-45 Connector

Modem Initialization String: Add \R2 to the Compaq Microcom 4000 modem initialization string recommended on page 1 to enable DSR.

Connecting to Xyplex

Connecting to an RJ-45 female Xyplex

If your Xyplex has an RJ-45 female connector, use the following RJ-45 (male) to RJ-45 (male) cable (See Diagram 1).

Compaq 8-pin RJ-45	Xyplex 8-pin RJ-45	Function	Abbrev.
1	—	Ring Indicator	RI
2	7	Carrier Detect	DCD
3	2	Data Terminal Ready	DTR
4	4 & 5	Signal Ground	GND
5	6	Received Data	RXD
6	3	Transmitted Data	TXD
7	1	Clear To Send	CTS
8	8	Request To Send	RTS

Table 9: Pinouts for a Compaq Microcom 4000 8-pin RJ-45 Connector and a Xyplex 8-pin RJ-45 Connector

Xyplex: The Xyplex communication servers require hardware flow control be enabled.

Connecting to Control RocketPort

Modem Initialization String: For all RocketPort installations, add \R2 to the Compaq Microcom 4000 modem initialization string recommended on page 1 to enable DSR instead of RI.

Connecting to an RJ-45 female RocketPort

If your RocketPort has an RJ-45 female connector, use the following RJ-45 (male) to RJ-45 (male) cable (See Diagram 1).

Compaq 8-pin RJ-45	RocketPort 8-pin RJ-45	Function	Abbrev.
1	7	Data Set Ready	DSR
2	6	Carrier Detect	DCD
3	2	Data Terminal Ready	DTR
4	3	Signal Ground	—
5	5	Received Data	RXD
6	4	Transmitted Data	TXD
7	8	Clear To Send	CTS
8	1	Request To Send	RTS

Table 10: Pinouts for a Compaq Microcom 4000 8-pin RJ-45 Connector and a RocketPort 8-pin RJ-45 Connector

Request Part Number RJ-MC-06 from:

Express Systems & Peripherals
150 East Commodore Blvd
Jackson, NJ 08527

800-222-0172

Connecting to DB-25 Male RocketPort

If your RocketPort has a DB-25 male connector, use the following RJ-45 (female) to DB-25 (female) serial DTE adapter.

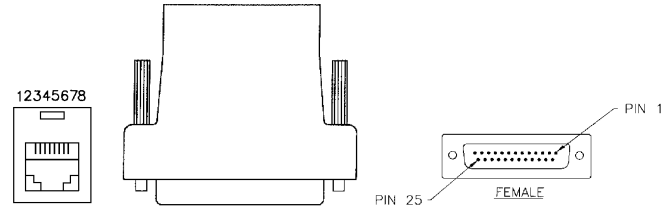

Diagram 5: RJ-45 (female) to DB-25 (female) Adapter

RJ-45	DB-25	Function	Abbrev.
—	1	Shield	—
6	2	Transmitted Data	TXD
5	3	Received Data	RXD
8	4	Request To Send	RTS
7	5	Clear To Send	CTS
1	6	Data Set Ready	DSR
4	7	Signal Ground	—
2	8	Carrier Detect	DCD
—	15	Transmit Clock	—
—	17	Receive Clock	—
—	18	Local Loopback	LL
3	20	Data Terminal Ready	DTR
—	21	Remote Loopback	RL
—	22	Ring Indicator	RI
—	24	External Clock	EXCK
—	25	Test Indicator/Mode	—

Table 11: Pinouts for the RJ-45 (female) to DB-25 (female) Adapter

RocketPort: When connecting the Compaq Microcom 4000 female RJ-45 serial DTE connectors to a RocketPort with male DB-25 connectors, a straight through RJ-45 male to RJ-45 male cable of appropriate length is required for use with the adapter.

Connecting to DB-9 Male RocketPort

If your RocketPort has a DB-9 male connector, use the following RJ-45 (female) to DB-9 (female) serial DTE adapter.

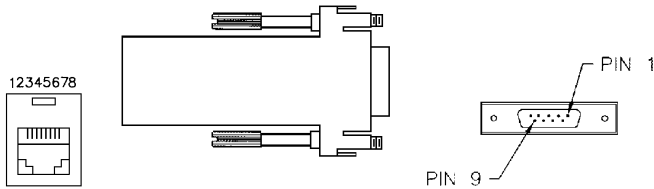

Diagram 6: RJ-45 (female) to DB-9 (female) Adapter

RJ-45	DB-9	Function	Abbrev.
2	1	Carrier Detect	DCD
5	2	Received Data	RXD
6	3	Transmitted Data	TXD
3	4	Data Terminal Ready	DTR
4	5	Signal Ground	—
1	6	Data Set Ready	DSR
8	7	Request To Send	RTS
7	8	Clear To Send	CTS
—	9	Ring Indicator	RI

Table 12: Pinouts for the RJ-45 (female) to DB-9 (female) Adapter

RocketPort: When connecting the Compaq Microcom 4000 female RJ-45 serial DTE connectors to a RocketPort with male DB-9 connectors, a straight through RJ-45 male to RJ-45 male cable of appropriate length is required for use with the adapter.

Connecting to a 3Com Access Builder

Modem Initialization String: Add \R1 to the Compaq Microcom 4000 modem initialization string recommended on page 1 to enable RI for both the DB-25 and RJ-45 versions of the 3Com Access Builder.

RJ-45 (male) to DB-25 (male) Cable Pinouts

Use this RJ-45 (female) to DB-25 (male) serial DTE adapter.

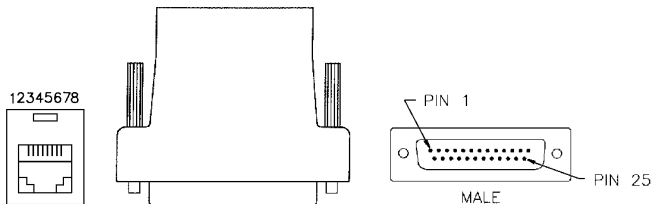

Diagram 7: RJ-45 (female) to DB-25 (male) Adapter - Compaq Part Number 178697-B21 (Set of 4)

RJ-45	DB-25	Function	Abbrev.
—	1	Shield	—
6	2	Transmitted Data	TXD
5	3	Received Data	RXD
8	4	Request To Send	RTS
7	5	Clear To Send	CTS
—	6	Data Set Ready	DSR
4	7	Signal Ground	—
2	8	Carrier Detect	DCD
—	15	Transmit Clock	—
—	17	Receive Clock	—
—	18	Local Loopback	LL
3	20	Data Terminal Ready	DTR
—	21	Remote Loopback	RL
1	22	Ring Indicator	RI
—	24	External Clock	EXCK
—	25	Test Indicator/Mode	—

Table 13: Pinouts for the RJ-45 (female) to DB-25 (male) Adapter
Use this adapter to connect to the back of the Access Builder. Use a straight through RJ-45 male cable from the RJ-45 end of the Compaq adapter to the Compaq Microcom 4000.

RJ-45 (male) to RJ-45 (male) Cable Pinouts - (See Diagram 1)

Compaq 8-pin RJ-45	Access Builder 8-pin RJ-45	Function	Abbrev.
1	5	Ring Indicator	RI
2	8	Carrier Detect	DCD
3	1	Data Terminal Ready	DTR
4	4	Signal Ground	—
5	2	Received Data	RXD
6	3	Transmitted Data	TXD
7	6	Clear To Send	CTS
8	7	Request To Send	RTS

Table 14: Pinouts for a Compaq Microcom 4000 8-pin RJ-45 Connector to a 3Com Access Builder 8-pin RJ-45 Connector

Connecting to a Bay Networks 5390

RJ-45 (male) to RJ-45 (male) Cable Pinouts - (See Diagram 1)

Compaq 8-pin RJ-45	Bay 5390 8-pin RJ-45	Function	Abbrev.
1	7	Data Set Ready	DSR
2	4	Carrier Detect	DCD
3	2	Data Terminal Ready	DTR
4	6	Signal Ground	—
5	5	Received Data	RXD
6	3	Transmitted Data	TXD
7	8	Clear To Send	CTS
8	1	Request To Send	RTS

Table 15: Pinouts for a Compaq Microcom 4000 8-pin RJ-45 Connector to a Bay Networks 5390 8-pin RJ-45 Connector

Modem Initialization String: Add VR2 to the Compaq Microcom 4000 modem initialization string recommended on page 1 to enable DSR.

Cabling to the Management Port

The Compaq Microcom 4000's management port is a DB-9 female and can be connected directly to a serial port on the back of a PC or to a modem for remote access to the management port. Each chassis connected to a PC running Compaq 4000 Manager must be cabled individually to the PC.

Management Port to PC Serial Port

For local management, connect a Compaq Microcom 4000 chassis directly to a serial port on a PC using the following cable:

DB-9 (male) to DB-9 (female)

Mgmt Port DB-9 Male	PC Comm DB-9 Female	Function	Abbrev.
1	1	Carrier Detect	DCD
2	2	Received Data	RXD
3	3	Transmitted Data	TXD
4	4	Data Terminal Ready	DTR
5	5	Signal Ground	—
6	6	Data Set Ready	DSR
7	7	Request To Send	RTS
8	8	Clear To Send	CTS
9	9	Ring Indicator	RI

Table 16: DB-9 Male to DB-9 Female Cable Pinouts

Management Port to Compaq Microcom 4000 Modem

The Compaq Microcom 4000 chassis can be managed remotely by dialing into one of the Compaq Microcom 4000 modems. This modem needs to be dedicated to chassis management. It is necessary to connect the Compaq Microcom 4000 modem to the Compaq Microcom 4000 chassis management port using an RJ-45 male to RJ-45 male cable and a null

DB-9 adapter. The null modem adapter (part number 363955-B21) is included with your *Compaq 4000 Manager* software.

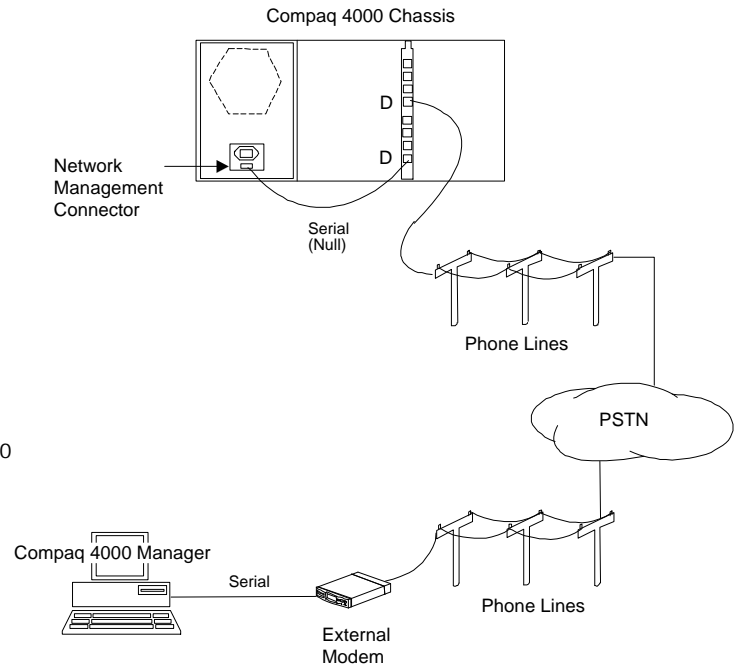

Diagram 8: Remote Management with a Compaq Microcom 4000 Modem DB-9 (male) to RJ-45 (female)

	DB-9 Pin	RJ-45 Pin
TXD	3	5
RXD	2	6
RTS	7	7
CTS	8	8
DSR	6	—
CD	1	3
DTR	4	2
GND	5	4
RI	9	1

Table 17: Serial Null Modem Pinouts

Modem Initialization String:

AT&F\$B9600-O4%U1Q2&D0&C1\Q0S0=1*W

Management Port to External Modem

Connect a Compaq Microcom 4000 chassis to an external modem to remotely manage the chassis with the following cable: 380017-B21

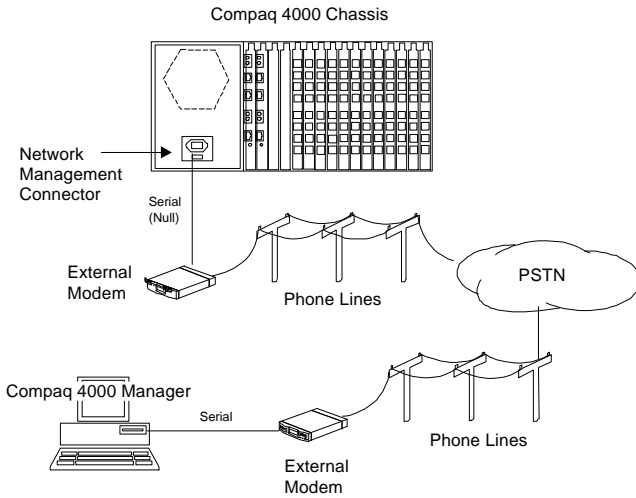

Diagram 9: Remote Management with an External modem

DB-9 (male) to DB-25 (male) (RS-232)

DB-9	Pin	Pin	DB-25
DCD	1	20	DTR
DSR	6	20	—
RXD	2	2	TXD
TXD	3	3	RXD
DTR	4	8	DCD
—	4	6	DSR
GND	5	7	GND
RTS	7	5	CTS
CTS	8	4	RTS

Table 18: DB-9 (male) to DB-25 (male) RS-232 Null Cable

Modem Initialization String:

If the modem connected to the management port on the Compaq Microcom 4000 is a Compaq modem with Compaq MODEMWARE firmware use the following initialization string:

AT&F\$B9600-O4%U1Q2&D0&C1\Q0S0=1*W

For all other modems including Compaq modems with Rockwell firmware do the following :

1. Set the terminal used to setup the modem to 9600, 8 data bits, and no parity.
2. Send the following initialization string to the modem:

AT&F&D0&C1S0=1&K0Q1&W

3. Connect the modem to the management port.

Connecting to an Equinox RJ Port Module

RJ-45 (male) to RJ-45 (male) Cable Pinouts - (See Diagram 1)

Compaq 8-pin RJ-45	Equinox 10-pin RJ-45	Function	Abbrev.
—	1	Ring Indicator	RI
1	10	Data Set Ready	DSR
2	8	Carrier Detect	DCD
3	3	Data Terminal Ready	DTR
4	5	Signal Ground	—
	7	Signal Ground	—
5	4	Received Data	RXD
6	6	Transmitted Data	TXD
7	9	Clear to Send	CTS
8	2	Request To Send	RTS

Table 19: Pinouts for a Standard 8-pin RJ-45 Connector and an Equinox 10-pin RJ-45 Connector

Request Equinox Part Number 690294 from:
Equinox
One Equinox Way
Sunrise, FL 33351
Ph (954) 746-9000

Connecting to a Cyclades Cyclom-Y

RJ-45 (male) to RJ-45 (male) Cable Pinouts - (See Diagram 1)

Compaq 8-pin RJ-45	Cyclades 10-pin RJ-45	Function	Abbrev.
1	9	Data Set Ready	DSR
—	10	Ring Indicator	RI
2	8	Carrier Detect	DCD
3	3	Data Terminal Ready	DTR
4	5	Signal Ground	—
5	7	Received Data	RXD
6	4	Transmitted Data	TXD
7	6	Clear to Send	CTS
8	2	Request To Send	RTS
—	1	—	—

Table 20: Pinouts for a Standard 8-pin RJ-45 Connector and a Cyclades 10-pin RJ-45 Connector

Modem Initialization String: Add "R2" to the modem initialization string to enable DSR, or, if pin 1 of the Compaq Microcom 4000 is connected to pin 10 of the Cyclom-Y add "R0" or "R1".

Connecting to a Cyclades Cyclom-Z

RJ-45 (male) to RJ-45 (male) Cable Pinouts - (See Diagram 1)

Compaq 8-pin RJ-45	Cyclades 8-pin RJ-45	Function	Abbrev.
1	8	Data Set Ready	DSR
2	7	Carrier Detect	DCD
3	2	Data Terminal Ready	DTR
4	4	Signal Ground	—
5	6	Received Data	RXD
6	3	Transmitted Data	TXD
7	5	Clear to Send	CTS
8	1	Request To Send	RTS

Table 21: Pinouts for a standard 8-pin RJ-45 connector and a Cyclades 8-pin RJ-45 connector

Modem Initialization String: Add "R2" to the modem initialization string to enable DSR.

Connecting to a Cyclades PathRAS

RJ-45 (male) to RJ-45 (male) Cable Pinouts - (See Diagram 1)

Compaq 8-pin RJ-45	Cyclades 8-pin RJ-45	Function	Abbrev.
1	8	Data Set Ready	DSR
2	7	Carrier Detect	DCD
3	1	Data Terminal Ready	DTR
4	4	Signal Ground	—
5	6	Received Data	RXD
6	3	Transmitted Data	TXD
7	5	Clear to Send	CTS
8	2	Request To Send	RTS

Table 22: Pinouts for a Standard 8-pin RJ-45 Connector and a Cyclades 8-pin RJ-45 Connector

Modem Initialization String: Add "R2" to the modem initialization string to enable DSR.

Request cables from:
Cyclades Corporation
41934 Christy Street
Fremont, CA 94538
800-882-9252 ext 274
Fax 510-770-0355

<http://www.cyclades.com>

Contacting Compaq

Compaq strives to keep this document up to date and as informative as possible. Please email any suggestions or comments to:

support@Compaq.com

See Internet address <http://www.compaq.com> for overall information on Compaq Computer.

For further information on Compaq networking products, contact Compaq Networking Products Division Sales at 1-800-544-5255 or the Compaq Networking Technical Support Center (post sales) at 1-800-386-2172. For customer support and information about Compaq and its products, call 1-800-OK-COMPAQ.

Compaq, MODEMWARE, and ADAPTive Switching are Compaq trademarks registered with the United States Patent and Trademark Office.

Other product names mentioned herein may be trademarks/registered trademarks of their respective companies.

©1998 Compaq Computer Corporation. All rights reserved. Printed in the U.S.A.