

COMPAQ

ProSignia Configuration Guidelines for NetWare v3.x

Compaq TechNote

Includes information on:

- Installation and configuration
- Performance optimization
- Integrated server management features
- Server management with Compaq Insight Manager and Server Manager/R

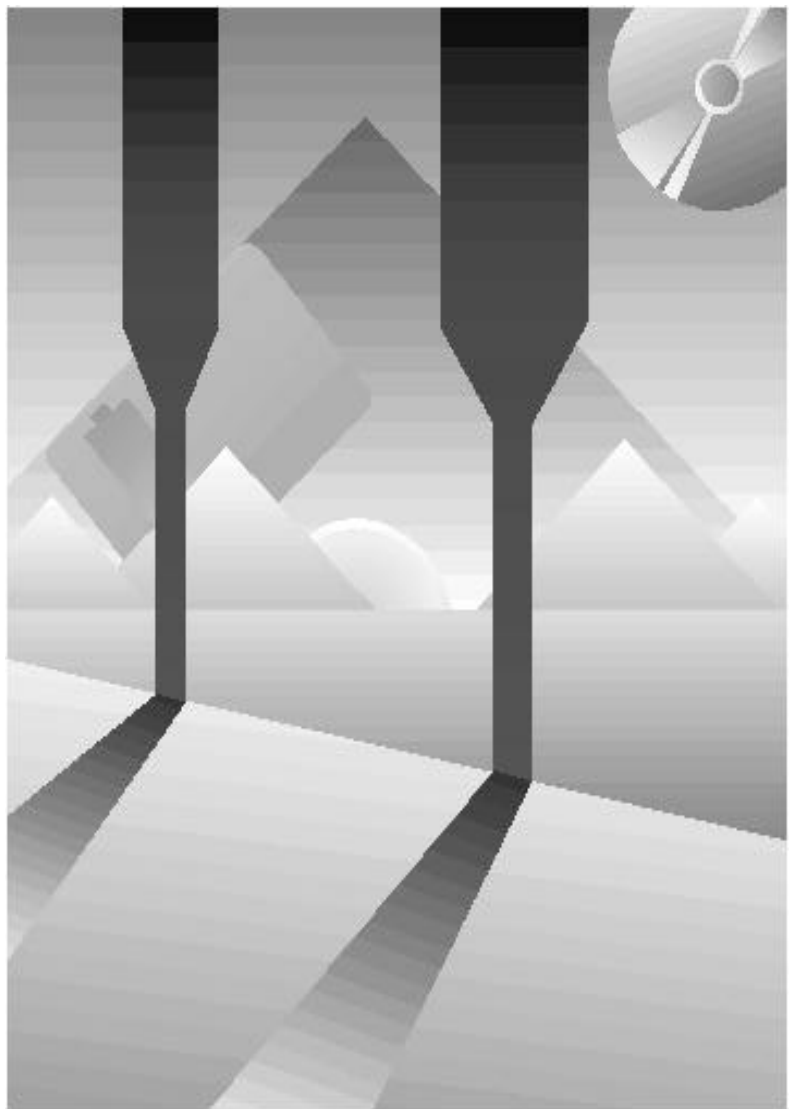

NOTICE

The information in this publication is subject to change without notice.

COMPAQ COMPUTER CORPORATION SHALL NOT BE LIABLE FOR TECHNICAL OR EDITORIAL ERRORS OR OMISSIONS CONTAINED HEREIN, NOR FOR INCIDENTAL OR CONSEQUENTIAL DAMAGES RESULTING FROM THE FURNISHING, PERFORMANCE, OR USE OF THIS MATERIAL.

This publication contains information protected by copyright. No part of this publication may be photocopied or reproduced in any form without prior written consent from Compaq Computer Corporation.

This publication does not constitute an endorsement of the product or products that were tested. The configuration or configurations tested or described may or may not be the only available solution. This test is not a determination of product quality or correctness, nor does it ensure compliance with any federal, state, or local requirements. Compaq does not warrant products other than its own strictly as stated in COMPAQ product warranties.

Product names mentioned herein may be trademarks and/or registered trademarks of their respective companies.

© 1992 Compaq Computer Corporation.
All rights reserved. Printed in the U.S.A.

COMPAQ, DESKPRO, SYSTEMPRO, and FASTART
Registered U.S. Patent and Trademark Office.

SYSTEMPRO/XL, ProSignia, and INSIGHT Manager are trademarks of
Compaq Computer Corporation.

COMPAQ TECHNOTE FOR NETWARE
COMPAQ PROSIGNIA CONFIGURATION GUIDELINES
FOR NETWARE V3.X

First Edition (December 1992)
Part Number 145537-001

Compaq Computer Corporation

CONTENTS

Chapter 1

TECHNOLOGY OVERVIEW

About This COMPAQ TechNote	1-1
COMPAQ ProSignia Features	1-2
System Processor	1-2
Hard Drive Subsystem	1-2
COMPAQ 32-Bit NetFlex Controller	1-6
Tape Backup Options	1-7
INSIGHT Server Management Technology	1-8

Chapter 2

HARDWARE PREPARATION

Configuring the Hard Drive Subsystem	2-3
Fast-SCSI-2 Subsystem	2-3
IDA-2 Subsystem	2-7
Configuring the NetFlex Controller	2-8
Preinstallation Checklist	2-8

Chapter 3

HARD DRIVE SUBSYSTEM CONFIGURATION

Configuring the Fast-SCSI-2 Subsystem	3-1
For No Fault Tolerance	3-4
For NetWare Drive Mirroring	3-5
For NetWare Controller Duplexing	3-7

HARD DRIVE SUBSYSTEM CONFIGURATION *(Continued)*

<u>Configuring the IDA-2 Subsystem</u>	3-11
<u> For NetWare Controller Duplexing</u>	3-11
<u> For COMPAQ Drive Mirroring, Distributed Data Guarding, Data Guarding, and No Fault Tolerance</u>	3-12
<u>Configuring an IDA-2 Subsystem and a Fast-SCSI-2 Subsystem</u>	3-14
<u>Using <i>SYNCPTCH.NLM</i> to Resynchronize Mirrored Partitions</u>	3-16

Chapter 4

32-BIT NETFLEX CONTROLLER

<u>Configuring the NetFlex Controller Board</u>	4-1
<u>Loading the NIC Device Driver</u>	4-3
<u>Viewing NIC Custom Statistics</u>	4-5
<u> Ethernet</u>	4-5
<u> Token Ring</u>	4-6

Chapter 5

CONFIGURATION OF ADDITIONAL SCSI DEVICES

<u>ASPI Support Configuration</u>	5-1
<u>ASPI Support for Multiple SCSI Devices</u>	5-2

Chapter 6

PERFORMANCE CONSIDERATIONS

<u>System Memory</u>	6-1
<u>Hard Drive Subsystem</u>	6-2
<u> Fast-SCSI-2 Subsystem</u>	6-3
<u> IDA-2 Subsystem</u>	6-11

PERFORMANCE CONSIDERATIONS *(Continued)*

Network Communication Subsystem	6-17
<u>SET MAXIMUM PHYSICAL RECEIVE PACKET SIZE</u>	<u>6-17</u>
<u>SET MINIMUM PACKET RECEIVE BUFFERS</u>	<u>6-18</u>
<u>SET MAXIMUM PACKET RECEIVE BUFFERS</u>	<u>6-20</u>

Chapter 7**SERVER MANAGEMENT**

Integrated Server Management Features	7-2
<u>Configuring <i>CPQHLTH.NLM</i></u>	<u>7-4</u>
<u>Configuring Automatic Server Recovery</u>	<u>7-5</u>
<u>Using COMPAQ Server Health Logs</u>	<u>7-10</u>
COMPAQ INSIGHT Manager	7-14
COMPAQ Server Manager/R	7-17
Questions and Answers	7-19

INDEX **I-1****FIGURES**

<u>2-1 Hardware Configuration for the COMPAQ ProSignia</u>	<u>2-2</u>
<u>2-2 JMP1 Jumper Block Setting for NetFlex Controller</u>	<u>2-8</u>
<u>3-1 COMPAQ Fast-SCSI-2 Hard Disk Device Drivers for NetWare</u>	<u>3-3</u>
<u>6-1 WRITE Test Results - Volume Block Size Comparison</u>	<u>6-6</u>
<u>6-2 READ Test Results - Volume Block Size Comparison</u>	<u>6-6</u>
<u>6-3 Effect of Striping Alignment and Misalignment</u>	<u>6-14</u>
<u>7-1 INSIGHT Management Framework</u>	<u>7-1</u>
<u>7-2 Automatic Server Recovery Flowchart</u>	<u>7-6</u>

TABLES

1-1	Supported Methods of Fault Tolerance	1-6
1-2	NetFlex Controller Standard Connectors	1-7
2-1	SCSI ID Jumper Settings	2-6
2-2	Preinstallation Checklist	2-9
3-1	COMPAQ Fast-SCSI-2 Device Drivers for NetWare	3-2
4-1	Interrupt Settings for Multiple NICs	4-2
6-1	Volume Block and Cache Buffer Size Recommendations	6-5
6-2	Hard Drive Performance and Capacity Comparison for 1 Gigabyte of Disk Space	6-9
6-3	Recommended Packet Sizes	6-18
6-4	Minimum Packet Receive Buffers	6-19
7-1	Benefits of Enabling ASR and Loading <i>CPQHLTH.NLM</i>	7-3
7-2	Critical Error Log Messages	7-11
7-3	INSIGHT Manager Options	7-15



Chapter 1

TECHNOLOGY OVERVIEW

The COMPAQ ProSignia represents a new class of Personal Computer (PC) Server for the NetWare environment. The COMPAQ ProSignia offers a variety of options for all server subsystems, including:

- Processor upgradability.
- Choice of COMPAQ 32-Bit Fast-SCSI-2 or COMPAQ Intelligent Drive Array (IDA) hard drive subsystem.
- Choice of Ethernet or Token Ring topology using the same Network Interface Controller (NIC).
- Additional external hard disk storage capacity and tape drive subsystems.

The COMPAQ ProSignia also offers features for advanced server management. These include fault prevention features, rapid recovery services, and fault tolerance options.

ABOUT THIS COMPAQ TECHNOTE

This COMPAQ TechNote is for system integrators with knowledge of COMPAQ server products and NetWare v3.x. It is supplemental to the COMPAQ product and NetWare documentation, providing guidelines for configuration of a COMPAQ ProSignia as a network server in a NetWare environment. Because the COMPAQ ProSignia provides a variety of available subsystem options, this COMPAQ TechNote discusses the configuration of each subsystem separately. It includes the following topics:

- *Chapter 1* - Product description and available options.
- *Chapter 2* - Server hardware preparation and COMPAQ EISA configuration.
- *Chapter 3* - Hard disk configuration for IDA-2 and Fast-SCSI-2 subsystems in various fault tolerant environments.
- *Chapter 4* - Configuration of the COMPAQ 32-Bit NetFlex Controller.

- **Chapter 5** - Configuration of backup support options and other SCSI devices.
- **Chapter 6** - Server performance considerations and optimization.
- **Chapter 7** - Server management using integrated features of the COMPAQ ProSignia and optional server management tools, such as COMPAQ INSIGHT Manager and COMPAQ Server Manager/R.

COMPAQ PROSIGNIA FEATURES

The following sections provide an overview of the COMPAQ ProSignia product features.

SYSTEM PROCESSOR

The COMPAQ ProSignia supports current 32-bit Intel system processors, such as the Intel 486/33 and the Intel 486DX2/66, and is compatible with current and future Intel OverDrive Processors. You can upgrade your COMPAQ ProSignia by adding an Intel OverDrive Processor (P23T or P24T) to the Intel OverDrive Socket on the server system board.

In CPU-intensive environments, such as database services, the speed of the system processor and system memory affect the performance of the server. Both the 486/33 and the 486DX2/66 include a 256-Kbyte second-level two-way set associative write-back cache to store the most recently used data, so that some requests can be read from cache rather than from disk. Using write-back cache can improve server performance in CPU-intensive environments.

NOTE: COMPAQ ProSignia does not support multiple processors.

HARD DRIVE SUBSYSTEM

The COMPAQ ProSignia supports several hard drive subsystem technologies including Fast-SCSI-2 and intelligent drive arrays. The COMPAQ ProSignia includes Fast-SCSI-2 support on the system board, allowing you to configure a hard drive subsystem without requiring a hard drive controller board to occupy an expansion slot. The Intelligent Drive Array Controller-2 (IDA-2) allows you to configure up to three drive array pairs.

The COMPAQ ProSignia also supports various methods of fault tolerance, depending on the hard drive configuration that you select for your server. These include Redundant Array of Inexpensive Disks (RAID) 1, RAID 4, and RAID 5.

Chapter 3 of this COMPAQ TechNote provides configuration guidelines for the IDA-2 and the Fast-SCSI-2 hard drive subsystems.

Subsystem Technology

The COMPAQ ProSignia includes several hard drive subsystem configurations including Fast-SCSI-2 and IDA-2. The following sections describe these subsystems.

FAST-SCSI-2 SUBSYSTEM

The COMPAQ ProSignia integrates the COMPAQ 32-Bit Fast-SCSI-2 Controller on the system board, allowing access for up to seven SCSI devices without using an EISA slot. Optional Fast-SCSI-2 Controller boards are also available for controller duplexing or for expanding storage capacity.

The Fast-SCSI-2 Controller provides 32-bit bus-master operations and 10-megabytes-per-second data transfer rates, allowing high throughput in many network application environments, including resource-sharing and database service.

The Fast-SCSI-2 Controller also supports tagged command queuing, which allows the Fast-SCSI-2 hard drive to queue and sort multiple commands, and then execute multiple commands simultaneously.

The Fast-SCSI-2 Controller device driver provides *scatter/gather*, a capability that reduces the overhead resulting from the negotiation between controller and SCSI device. In most SCSI-based hard drive subsystems, the controller negotiates with the SCSI device to service read or write requests. This negotiation includes location of the data, availability of the SCSI device, access to the SCSI bus, and so on. Using *scatter/gather* reduces the negotiation process by combining several requests, so the controller and SCSI device negotiate once for several requests, rather than once for each request. *Scatter/gather* can provide up to 20 percent performance improvement in overall disk I/O throughput.

The Fast-SCSI-2 Controller also supports interleaved data transfers. Fast-SCSI-2 hard drives logically disconnect from the SCSI bus when no data transfers occur and reconnect to the SCSI bus during data transfers. Commands can be passed to other drives while drives that are given read/write commands disconnect from the SCSI bus to perform disk operations. Interleaved data transfers can substantially increase overall subsystem performance.

For example, when drive 1 receives a read request, drive 1 disconnects from the SCSI bus while it searches for the proper track and sectors. During this time, the controller can send another request to drive 2 while drive 1 is disconnected. Both drives can perform their operations simultaneously. When either drive is ready to fulfill its request, the drive reconnects to the SCSI bus to complete the operation.

Fast-SCSI-2 Controllers comply with ANSI SCSI-2 standards, allowing the COMPAQ ProSignia to support 8-bit SCSI-2 devices. COMPAQ SCSI-2 device drivers for NetWare include Open-Layered Software Architecture (OLSA), based on the common access method (CAM) recommended by the ANSI SCSI CAM committee. OLSA provides software support for multiple hard drives, tape drives, and other SCSI devices on the same controller. Therefore, the COMPAQ ProSignia can support different SCSI devices on a single integrated SCSI controller.

The Advanced SCSI Programming Interface (ASPI) compatibility interface provides support for existing third-party tape backup software, such as Cheyenne ARCserve software. Cheyenne ARCserve provides fully automated backup and restore services for NetWare v3.x networks and COMPAQ tape drives such as the 5.0-Gigabyte Digital Audio Tape (DAT) Drive and the 525-Megabyte Tape Drive. The NetWare Programs from Compaq diskette includes the device drivers and ASPI driver for the COMPAQ ProSignia.

Chapter 2 of this COMPAQ TechNote discusses Fast-SCSI-2 hardware configuration. Chapter 3 discusses NetWare installation specific to the Fast-SCSI-2 subsystem, including fault tolerance configuration. Chapter 5 provides support information for configuring SCSI tape drives with other SCSI devices, such as Fast-SCSI-2 hard drives.

IDA-2 SUBSYSTEM

You can configure the COMPAQ ProSignia with the COMPAQ Intelligent Drive Array Controller-2 (IDA-2 Controller) for total internal hard disk storage of up to 3.06 gigabytes (three 1020-megabyte drive array pairs).

The COMPAQ IDA-2 Controller, like the 32-Bit IDA Controller, provides parallel data transfers and simultaneous request services. It also manages drive array access by queuing and servicing multiple read requests.

The IDA-2 Controller includes the COMPAQ 4-Megabyte Array Accelerator Write Cache, a memory module that caches up to 2 megabytes of data before sending the data to disk. The Array Accelerator includes non-volatile buffer memory for write operations and on-board batteries to preserve the data in the buffer for up to 5 to 8 days in the event of a power loss. The Array Accelerator uses the remaining 2 megabytes of memory to mirror the data, so that if a parity error occurs, the Array Accelerator retains an undamaged copy of the data. This feature is called Array Accelerator Data Integrity.

The IDA-2 Controller supports RAID 5 fault tolerance by providing distributed data guarding. Like COMPAQ drive mirroring and data guarding, distributed data guarding is independent of the operating system, and like data guarding, uses 25 percent of the drive array as a parity "drive" to store encoded data. Instead of storing all encoded data on one drive, however, distributed data guarding stores data on a portion of each drive. If a single drive fails, then the data is rebuilt from the encoded data residing on the remaining drives.

Chapter 2 of this COMPAQ TechNote discusses IDA-2 hardware configuration. Chapter 3 of this COMPAQ TechNote discusses NetWare installation specific to the IDA-2 subsystem, including fault tolerance configuration.

Fault Tolerance

Depending on your selection of hard drive subsystem, the COMPAQ ProSignia supports a variety of fault tolerance choices. Table 1-1 shows the fault tolerance methods supported by Fast-SCSI-2 and IDA-2.

**Table 1-1
Supported Methods of Fault Tolerance**

RAID Level	IDA-2 Controller	Fast-SCSI-2 Controller
COMPAQ Drive Mirroring (RAID 1)	✓	
NetWare Drive Mirroring (RAID 1)	✓	✓
NetWare Controller Duplexing	✓	✓
COMPAQ Data Guarding (RAID 4)	✓	
COMPAQ Distributed Data Guarding (RAID 5)	✓	

NOTE: Controller duplexing requires a minimum of two controllers. These controllers can include IDA-2 Controllers or Fast-SCSI-2 Controllers (both integrated and board versions). For controller duplexing, the NetWare partitions must be the same size.

COMPAQ 32-BIT NETFLEX CONTROLLER

The COMPAQ 32-Bit NetFlex Controller uses the Texas Instruments SuperEagle chip set to provide Ethernet and Token Ring (both 4-Mb/s and 16-Mb/s) support on the same controller. The NetFlex Controller comes "Ethernet-ready," but it also supports a plug-in Token Ring adapter module that provides 16/4 Token Ring support. A jumper block on the NetFlex Controller also defines the topology (that is, whether it is configured for Ethernet or Token Ring).

Standard connectors for both Ethernet and Token Ring support include those listed in Table 1-2.

Table 1-2
NetFlex Controller Standard Connectors

Ethernet	Token Ring 16/4
UTP (uses RJ-45 Connector)	STP (uses DB-9 Connector)
AUI (uses DB-15 Connector)	UTP (uses RJ-45 Connector)

NOTE: You can also implement Ethernet BNC (ThinNet) by using a connector that converts AUI to BNC. This connector is available from Compaq. For more information, contact your Authorized COMPAQ Reseller or Authorized COMPAQ Service Provider.

Chapter 4 of this COMPAQ TechNote provides configuration guidelines for the NetFlex Controller.

TAPE BACKUP OPTIONS

The COMPAQ ProSignia supports two optional tape drives: the 5.0-Gigabyte Digital Audio Tape (DAT) Drive or the 525-Megabyte Tape Drive. Both tape drives can connect to the Integrated Fast-SCSI-2 Controller on the COMPAQ ProSignia system board or to an optional 32-Bit Fast-SCSI-2 Controller board. The 5.0-Gigabyte DAT Drive can back up data at up to 28 megabytes per minute, and the 525-Megabyte Tape Drive can back up data at up to 14 megabytes per minute.

The Advanced SCSI Programming Interface (ASPI) compatibility interface provides support for existing third-party tape backup software, such as Cheyenne ARCserve. Cheyenne ARCserve provides fully automated backup and restore services for NetWare v3.x networks and COMPAQ tape drives such as the 5.0-Gigabyte DAT Drive and the 525-Megabyte Tape Drive.

Chapter 5 of this COMPAQ TechNote provides support information for configuring SCSI tape drives and other SCSI devices.

INSIGHT SERVER MANAGEMENT TECHNOLOGY

COMPAQ INSIGHT Server Management technology provides a framework that encompasses a variety of COMPAQ products and features that monitor server configuration and server activity. INSIGHT Server Management technology includes features that are integrated in the COMPAQ ProSignia and optional server management tools to provide both real-time and historical data from your server. These optional server management tools include the COMPAQ INSIGHT Manager and COMPAQ Server Manager/R.

The COMPAQ ProSignia includes integrated server management features that report server status and log errors in non-volatile RAM, as well as restart the server in the event of a server failure. In addition to these integrated server management features, COMPAQ INSIGHT Manager and COMPAQ Server Manager/R can monitor temperature and voltage variations, NetWare operating system status, and subsystem capacity and performance.

! **IMPORTANT:** When configuring the COMPAQ ProSignia and COMPAQ Server Manager/R, ensure that the revision of the Server Manager/R board is *revision N or greater*. The revision indicator is marked on the board above the battery.

If you configure the Server Manager/R board in the COMPAQ ProSignia and EISA Configuration Utility Version 2.10 displays a message stating that the board is not supported, obtain revision N or greater. Contact your Authorized COMPAQ Reseller or Authorized COMPAQ Service Provider, or call the Compaq Customer Support Center at 1-800-345-1518 in North America. In Canada, call 1-800-263-5868. Outside the United States and Canada, contact the local Compaq Computer Corporation office from which you normally receive support.

Chapter 7 describes each of these integrated server management features and optional server management tools. It also provides guidelines for combining these tools and using them to obtain the information you need to manage your servers more efficiently. To configure the integrated server management features and to use these server management features and tools, refer to Chapter 7 of this COMPAQ TechNote.



Chapter 2

HARDWARE PREPARATION

For this COMPAQ TechNote, Compaq engineers performed integration testing on a COMPAQ ProSignia configured as follows. Figure 2-1 illustrates the recommended hardware configuration. Refer to Figure 2-1 when installing controllers, expansion boards, and mass storage devices to ensure that your configuration is optimal.

- COMPAQ ProSignia Model 486/33 1050
 - Additional 3150 megabytes of hard disk space (for a total of 4.2 gigabytes of hard disk space)
 - 16 megabytes of system memory (8 megabytes of standard system memory with an additional 8 megabytes of system memory)
 - Integrated Fast-SCSI-2 Controller
(Fast-SCSI-2 Controller board needed for controller duplexing)
 - COMPAQ 32-Bit NetFlex Controller

NOTE: The amount of system memory for the server and the Fast-SCSI-2 hard drive subsystem was based on a 8-Kbyte volume block size.

- COMPAQ ProSignia Model 486/33 1020
 - Additional 1020 megabytes of hard disk space (for a total of 2.04 gigabytes of hard disk space)
 - 16 megabytes of system memory (8 megabytes of standard system memory with an additional 8 megabytes of system memory)
 - COMPAQ Intelligent Drive Array Controller-2 (IDA-2)
 - COMPAQ 32-Bit NetFlex Controller

NOTE: The amount of system memory for the server and IDA-2 subsystem was based on an 8-Kbyte volume block size.

! **IMPORTANT:** The minimum recommended version of the COMPAQ EISA Configuration Utility is version 2.10. Earlier versions of the EISA Configuration Utility do not support many of the COMPAQ ProSignia features.

**Figure 2-1
Hardware Configuration
for the COMPAQ ProSignia**

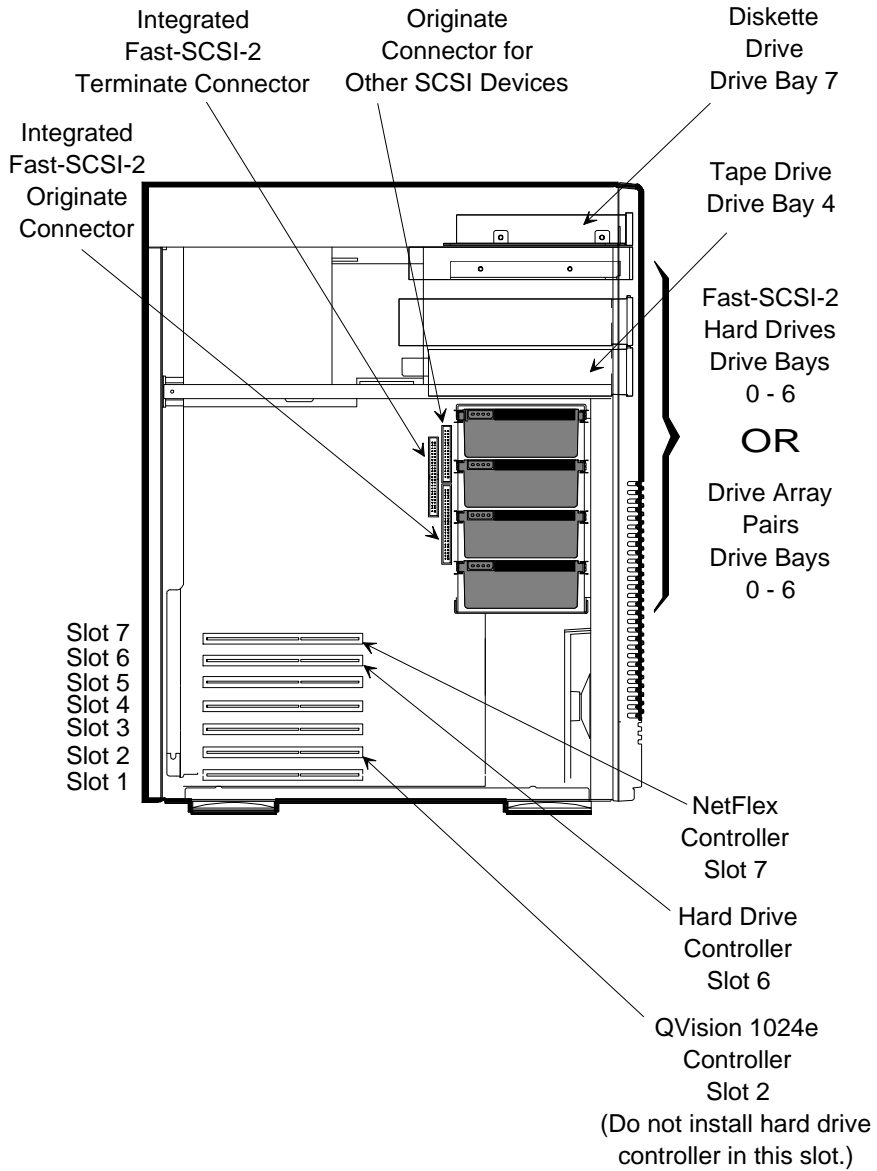

This chapter provides hardware configuration information for each of the components in the COMPAQ ProSignia, including the following:

- Hard drive configuration, including jumper settings, location within the system unit, and cable requirements.
- Hard drive controller configuration for the IDA-2 Controller, the Integrated Fast-SCSI-2 Controller, and the Fast-SCSI-2 Controller board, including recommended location in the system unit and cable options.
- NetFlex Controller configuration, including jumper settings on the board and location in the system unit.

CONFIGURING THE HARD DRIVE SUBSYSTEM

Hard drive subsystem configuration depends on the type of hard drives that are installed in the COMPAQ ProSignia. IDA-2 subsystem configuration requirements differ from those of the Fast-SCSI-2 subsystem. The following sections discuss configuration of the hard drive subsystem hardware in the COMPAQ ProSignia, including location of the drives in the system unit, cabling requirements, and jumper settings for Fast-SCSI-2 configuration.

-
- ! **IMPORTANT:** EISA Configuration Utility version 2.10 does not allow you to configure any hard drive controller with LEDs in slot 2 of the COMPAQ ProSignia. Slot 2 is configured for use with the QVision 1024/E Controller, including the QVision QuickBlank feature. You can, however, install other expansion boards in slot 2.
-

FAST-SCSI-2 SUBSYSTEM

When configuring the Fast-SCSI-2 subsystem, you can use the Integrated Fast-SCSI-2 on the COMPAQ ProSignia system board. However, you can also configure your server for controller duplexing using the Integrated Fast-SCSI-2 Controller for your primary controller and a Fast-SCSI-2 Controller board for your secondary controller.

Fast-SCSI-2 Controller

The COMPAQ EISA Configuration Utility recognizes the Integrated Fast-SCSI-2 Controller as "installed" in a virtual "slot 8" of the COMPAQ ProSignia. To add more expansion boards, such as additional hard drive controllers or NICs, you can use slots 1, 3, 4, 5, 6, or 7.

! **IMPORTANT:** EISA Configuration Utility version 2.10 does not allow you to configure any hard drive controller with LEDs in slot 2 of the COMPAQ ProSignia. Slot 2 is configured for use with the QVision 1024/E Controller, including the QVision QuickBlank feature. You can, however, install other expansion boards in slot 2.

The COMPAQ ProSignia also includes a 50-pin external SCSI-2 connector. The Integrated Fast-SCSI-2 Connector and the external SCSI-2 connector use the same SCSI bus. Because they use the same SCSI bus, you can attach a combined total of seven SCSI devices to it.

Hard Drives

The COMPAQ ProSignia supports the 330-Megabyte Fast-SCSI-2 Hard Drives, the 550-Megabyte Fast-SCSI-2 Hard Drives, and the 1050-Megabyte Fast-SCSI-2 Hard Drives. Each of these hard drives, and other SCSI devices that are attached to a single SCSI bus, must have a unique SCSI ID from 0 to 6. The drive bays are numbered from 0 to 7 from the bottom of the system unit to the top. The drive bay positions for the COMPAQ ProSignia are illustrated in Figure 2-1.

NOTE: Drive bay 7 contains the server diskette drive. EISA Configuration Utility does not assign a SCSI ID to drive bay 7.

ASSIGNING SCSI IDS

The Fast-SCSI-2 drives have jumpers that you set to configure the SCSI ID. When assigning SCSI IDs, use the following rules:

- The SCSI ID determines the priority of the SCSI device. The higher the SCSI ID, the higher the priority on the SCSI bus. The EISA Configuration Utility assigns the Fast-SCSI-2 Controller SCSI ID=7, giving the Fast-SCSI-2 Controller the highest priority.
- Assign each SCSI ID to match the number of the physical drive bay in which the device resides. For example, drive bay 0 should include a Fast-SCSI-2 drive with SCSI ID=0, and drive bay 1 should include a Fast-SCSI-2 drive with SCSI ID=1. This eliminates administrative "nightmares" in the event of a failed drive.

If a drive failure occurs, the failed drive is identified by the SCSI ID. If you do *not* match the SCSI ID to the drive bay number for each device and a drive fails, you cannot identify the failed drive unless you remove each drive from the drive bay and identify the failed drive by the SCSI ID jumper settings.

- For maximum performance, when connecting a variety of SCSI devices to the same SCSI bus, assign the low-throughput devices (such as tape drives) higher SCSI IDs (SCSI ID=4 to SCSI ID=6). This allows low-throughput devices equal access to the SCSI bus when sharing the bus with high-throughput devices and prevents "starvation" of the low-throughput devices.

If you assign SCSI IDs according to the previous "drive bay" rule, low-throughput devices residing in drive bays 4, 5, and 6 (upper drive bays) will have higher SCSI IDs (IDs to match the drive bay numbers) and higher priority.

NOTE: When you configure low-throughput devices, such as tape drives, on the same SCSI bus as high-throughput devices, such as the Fast-SCSI-2 hard drives, the low-throughput devices do *not* affect the performance of the high-throughput devices. Each SCSI device negotiates its own throughput on the SCSI bus.

- Always install the server DOS partition on the device with the lowest SCSI ID. When the server reboots, the system ROM searches for the DOS partition on the device with the lowest SCSI ID.

SETTING SCSI DRIVE JUMPERS

Each factory-shipped Fast-SCSI-2 hard drive is set to SCSI ID=0, and all COMPAQ ProSignia Fast-SCSI-2 models are configured with the Fast-SCSI-2 drive in drive bay 0. If you plan more than one Fast-SCSI-2 hard drive for your server configuration, you must change the jumper settings on each drive to ensure that each drive is configured with a unique SCSI ID (0 through 6) for each SCSI bus on the server.

Table 2-1 provides the SCSI ID jumper settings for all models of COMPAQ Fast-SCSI-2 hard drives. An illustration of the physical locations of the jumpers is provided inside the cover of the COMPAQ ProSignia unit. Use Table 2-1 to set the SCSI IDs for your server hard drives.

Table 2-1
SCSI ID Jumper Settings

Recommended Drive Bay	SCSI ID	ID0	ID1	ID2
6	6	ON	ON	OFF
5	5	ON	OFF	ON
4	4	ON	OFF	OFF
3	3	OFF	ON	ON
2	2	OFF	ON	OFF
1	1	OFF	OFF	ON
0	0	OFF	OFF	OFF

Fast-SCSI-2 Cables

The Fast-SCSI-2 subsystem includes a variety of connector cables for the Fast-SCSI-2 Controller and accompanying SCSI devices. There are two 2-device cables and two 7-device cables. The 7-device cables allow you to configure SCSI devices, such as additional hard drives or tape drives, in the upper drive bays. The 2-device cables allow you to configure SCSI devices in drive bays 0 through 3 *only*. These cables are not long enough to reach the upper drive bays.

The following part numbers represent the available SCSI cables:

- PN 149117-001 - Seven-device cable for the Integrated Fast-SCSI-2 Controller.
- PN 149116-001 - Seven-device cable for the Fast-SCSI-2 Controller board.
- PN 149114-001 - Two-device cable for Models 330 and 550.
- PN 149113-001 - Two-device cable for the Fast-SCSI-2 Controller board.

-
- ! **IMPORTANT:** If you plan to configure *no internal* SCSI devices (hard drives or tape drives), the SCSI bus must be terminated on the COMPAQ ProSignia system board by using the SCSI Zero Device Cable (PN 143715-001). To obtain a SCSI Zero Device Cable, contact your Authorized COMPAQ Service Provider.
-

IDA-2 SUBSYSTEM

Install the COMPAQ IDA-2 Controller in slot 6 of the COMPAQ ProSignia. (The NetFlex Controller is preinstalled in slot 7.) If you install the IDA-2 Controller in any of slots 1 through 5, you must obtain special-length device cables to connect the IDA-2 Controller to drive bays 4 and 5.

-
- ! **IMPORTANT:** When configuring the COMPAQ ProSignia with an IDA-2 subsystem and no internal SCSI devices, in most cases the Integrated Fast-SCSI-2 Controller on the COMPAQ ProSignia system board must be terminated using the COMPAQ SCSI Zero Device Cable (PN 143715-001). You cannot disable the Integrated Fast-SCSI-2 Controller using EISA Configuration Utility. To obtain a SCSI Zero Device Cable, contact your Authorized COMPAQ Service Provider.

However, if are configuring a COMPAQ ProSignia with many expansion boards and you must share interrupts, you can configure the IDA-2 Controller to share an interrupt with the Integrated Fast-SCSI-2 Controller. In this case, the SCSI Zero Device Cable is not used.

IDA-2 subsystem configurations for the COMPAQ ProSignia include one of two connector cables for the IDA-2 Controller:

- PN 149112-001 - Standard cable for connecting up to two drive array pairs to an IDA-2 Controller. To use this cable, you must install the hard drives in drive bays 0 through 3.
- PN 149115-001 - Optional cable for connecting a third drive array pair (residing in drive bays 4 and 5) to an IDA-2 Controller.

CONFIGURING THE NETFLEX CONTROLLER

The COMPAQ 32-Bit NetFlex Controller can be configured for either Ethernet or Token Ring. The NetFlex Controller is preinstalled in slot 7 of the COMPAQ ProSignia and is preconfigured for the Ethernet network topology. You must obtain a COMPAQ DualSpeed Token Ring Module to modify the NetFlex Controller for a Token Ring environment. A jumper block on the NetFlex Controller also determines whether it is configured for Token Ring or for Ethernet operation. When configuring the NetFlex Controller for Token Ring, change the jumper block setting from ENET to TRING as shown in Figure 2-2

Figure 2-2
JMP1 Jumper Block Setting for NetFlex Controller

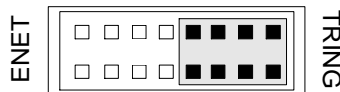

PREINSTALLATION CHECKLIST

Before beginning NetWare installation on the server, use the checklist in Table 2-2 to ensure that your server is ready for NetWare installation. The items in this checklist apply to all COMPAQ ProSignia configurations. For specific configuration information, such as configuring the COMPAQ ProSignia for hardware fault tolerance, Chapter 3, "Hard Drive Subsystem Configuration," provides detailed configuration procedures.



CAUTION: If you have not performed all of the items in this checklist, you may not be able to install NetWare successfully.

Table 2-2
Preinstallation Checklist

Before Beginning NetWare Installation, Did You...?

- ✓ Power on the server with the COMPAQ System Configuration diskette in the diskette drive and execute the EISA Configuration Utility?
- ✓ Select NetWare as the primary operating system in the EISA Configuration Utility?
- ✓ Configure all EISA and ISA boards in the server using EISA Configuration Utility and note slot numbers of all boards?
- ✓ Ensure that the EISA Configuration Utility reflects the desired number of logical drives?
- ✓ Install the COMPAQ Utilities (INSPECT Utility, DIAGNOSTICS software, and EISA Configuration Utility) in the Systems partition of the hard drive using the EISA Configuration Utility?
- ✓ Select the desired method of hardware fault tolerance if using an IDA-2 subsystem or select No Fault Tolerance if using a Fast-SCSI-2 subsystem?
- ✓ Create and activate a 10-megabyte DOS partition using the FDISK or FASTART Utility?
- ✓ Create and activate the partition on the SCSI device with lowest SCSI ID if using the Fast-SCSI-2 subsystem?
- ✓ Format the DOS partition and make it bootable?
- ✓ Install MS-DOS Version 5.0?
- ✓ Ensure that all existing DOS memory managers are disabled or removed from the *CONFIG.SYS* file?
- ✓ Create a NetWare subdirectory in the DOS partition and copy the NetWare files *SERVER.EXE*, *INSTALL.NLM*, *VREPAIR.NLM*, and *MONITOR.NLM* from the NetWare System-1, System-2, and System-3 diskettes?

Refer to the installation chart *Installing NetWare v3.11 on a Compaq Server* that ships with the COMPAQ ProSignia documentation for a more detailed explanation on basic COMPAQ ProSignia configuration and NetWare installation.



Chapter 3

HARD DRIVE SUBSYSTEM CONFIGURATION

-
- ! **IMPORTANT:** Before beginning installation, review the "Preinstallation Checklist" in Chapter 2 to ensure that you have completed the hardware configuration and the preparation for installing NetWare.
-

The COMPAQ ProSignia supports three different hard drive subsystem technologies: Fast-SCSI-2, Intelligent Drive Array-2 (IDA-2), and Integrated Drive Electronics (IDE). The following sections discuss configuration of the Fast-SCSI-2 and IDA-2 subsystems using the EISA Configuration Utility and provide special considerations for installation of NetWare on these hard drive subsystems.

NOTE: The IDE subsystem configuration is not discussed in this COMPAQ TechNote.

-
- ! **IMPORTANT:** EISA Configuration Utility version 2.10 does not allow you to configure any hard drive controller with LEDs in slot 2 of the COMPAQ ProSignia. Slot 2 is configured for use with the QVision 1024/E Controller, including the QVision QuickBlank feature. You can, however, install other expansion boards in slot 2.
-

CONFIGURING THE FAST-SCSI-2 SUBSYSTEM

The COMPAQ device drivers that provide SCSI-2 support for NetWare are implemented in a layered architecture that is based on the ANSI SCSI-2 Common Access Method (CAM) Transport and SCSI Interface Module (SIM) specification.

The device drivers in Table 3-1 support both the Fast-SCSI-2 Controller board and the Integrated Fast-SCSI-2 Controller for NetWare v3.x. These device drivers are included in a self-extracting *SCSI.EXE* file on the NetWare Programs from Compaq (NPFC) diskette. To access these device drivers, copy the *SCSI.EXE* file from the SCSI subdirectory of the NetWare Programs from Compaq diskette to the NetWare subdirectory in your server DOS partition and then execute it.

Table 3-1
COMPAQ Fast-SCSI-2 Device Drivers for NetWare

<i>CPQSDISK.DSK</i>	Device driver for Integrated Fast-SCSI-2 Controller and 32-Bit Fast-SCSI-2 Controller board.
<i>CPQSXPT.DSK</i>	Device driver that transports commands from SCSI device drivers (<i>CPQSDISK.DSK</i> and <i>CPQSASPI.NLM</i>) to low-level SCSI bus interface modules (<i>CPQS710.DSK</i>).
<i>CPQS710.DSK</i>	Low-level SCSI bus device driver for the 32-Bit Fast-SCSI-2 Controller board and for the Integrated Fast-SCSI-2 Controller. If you do not specify the SLOT parameter in the LOAD command line, the device driver finds and activates all Fast-SCSI-2 Controllers that were configured with the EISA Configuration Utility.
<i>CPQSASPI.NLM</i>	Device driver that provides the ASPI interface for tape backup programs, such as Cheyenne ARCserve.

NOTE: The *CPQS94.DSK* device driver, included on the NetWare Programs from Compaq diskette, is not supported on the COMPAQ ProSignia. It operates the Integrated Options Port on the COMPAQ SYSTEMPRO/XL.

Figure 3-1 illustrates the relationships among these device drivers, and the following sections discuss configuration of a COMPAQ ProSignia with a Fast-SCSI-2 hard drive subsystem.

Figure 3-1
COMPAQ Fast-SCSI-2 Hard Disk
Device Drivers for NetWare

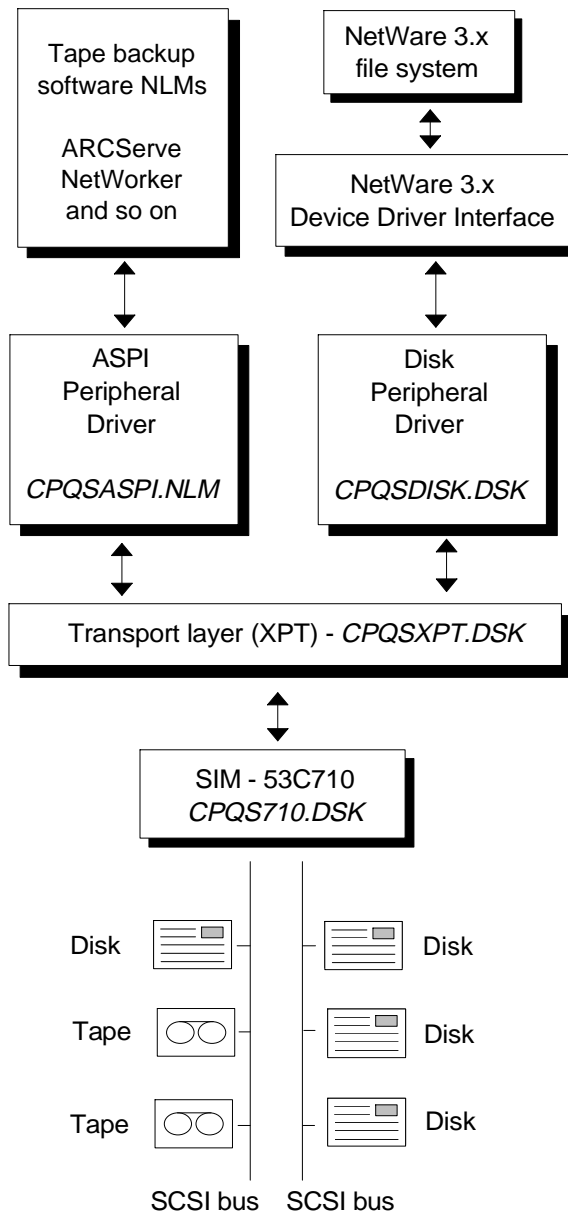

FOR NO FAULT TOLERANCE

-
- ! **IMPORTANT:** Before beginning installation, review the "Preinstallation Checklist" in Chapter 2 to ensure that you have completed the hardware configuration and the preparation for installing NetWare.
-

When configuring the Fast-SCSI-2 subsystem and installing NetWare with no fault tolerance, perform the following procedure:

1. Verify that the EISA Configuration Utility recognizes the Fast-SCSI-2 Controller.
2. From the DOS prompt, copy the *SCSI.EXE* file from the \SCSI subdirectory of the NetWare Programs from Compaq diskette to the \NW311 subdirectory of the server DOS partition.

NOTE: In this configuration procedure, the NetWare subdirectory in the server DOS partition is \NW311.

3. Enter the following from the DOS prompt. The *SCSI.EXE* file provides a series of *.NCF* files for COMPAQ hard drive subsystems.

SCSI

4. Copy the *SU001.NCF* file to a NetWare *STARTUP.NCF* file in the \NW311 subdirectory of the server DOS partition. This loads the appropriate device driver when you start the server. For example:

```
COPY C:\NW311\SU001.NCF C:\NW311\STARTUP.NCF
```

5. From the \NW311 subdirectory, enter the following.

SERVER

6. Name the server and provide it with a unique internal network number.
7. From the NetWare prompt, enter the following to load *INSTALL.NLM*.

LOAD INSTALL

8. Verify that the *STARTUP.NCF* file includes *LOAD* statements similar to the following for your Fast-SCSI-2 subsystem, so the device driver loads when you start the server.

```
LOAD C:\NW311\CPQSXPT  
LOAD C:\NW311\CPQS710  
LOAD C:\NW311\CPQSDISK
```

9. From the Installation Options menu, select *Disk Options*.
10. Select *Available Disk Options*. Each Fast-SCSI-2 hard drive should be displayed as a separate device, with Device #0 being 10 megabytes smaller than the remaining devices. Device #0 includes the 10-megabyte DOS partition.
11. Select *Partition Tables* and create the NetWare partitions for each device.
12. Create and mount NetWare volumes.
13. Continue the NetWare installation by installing the System and Public files.

Your Fast-SCSI-2 subsystem is configured with no fault tolerance, and NetWare System and Public files are installed. Continue your server configuration by installing the NetFlex Controller and loading NetFlex device drivers (see Chapter 4).

FOR NETWARE DRIVE MIRRORING

-
- ! **IMPORTANT:** Before beginning installation, review the "Preinstallation Checklist" in Chapter 2 to ensure that you have completed the hardware configuration and the preparation for installing NetWare.
-

When configuring the Fast-SCSI-2 subsystem and installing NetWare for drive mirroring, perform the following:

1. Verify that the EISA Configuration Utility recognizes the Fast-SCSI-2 Controller.
2. At the DOS prompt, copy the *SCSI.EXE* file from the \SCSI subdirectory NetWare Programs from Compaq diskette to the \NW311 subdirectory of the server DOS partition.

NOTE: In this configuration procedure, the NetWare subdirectory in the server DOS partition is \NW311.

3. Enter the following at the DOS prompt. The *SCSI.EXE* file provides a series of *.NCF* files for COMPAQ hard drive subsystems.

SCSI

4. Copy the *SU001.NCF* file to a NetWare *STARTUP.NCF* file in the \NW311 subdirectory of the server DOS partition. This file loads the appropriate hard disk device driver when you start the server. For example:

```
COPY C:\NW311\SU001.NCF C:\NW311\STARTUP.NCF
```

5. From the \NW311 subdirectory, enter the following:
SERVER
6. Name the server and provide the server with a unique internal network number.
7. From the NetWare prompt, enter the following to load *INSTALL.NLM*:
LOAD INSTALL
8. Verify that the *STARTUP.NCF* file includes LOAD statements similar to the following for your Fast-SCSI-2 subsystem, so the device driver loads when you start the server.

```
LOAD C:\NW311\CPQSXPT  
LOAD C:\NW311\CPQS710  
LOAD C:\NW311\CPQSDISK
```

9. From the Installation Options menu, select *Disk Options*.
10. Select *Available Disk Options*. Each Fast-SCSI-2 hard drive should be displayed as a separate device, with Device #0 being 10 megabytes smaller than the remaining devices. Device #0 includes the 10-megabyte DOS partition.
11. Select *Partition Tables* and create the NetWare partitions for each device.
12. From the Available Disk Options menu, select *Mirroring*.
13. Select the primary partition from the Partition Mirroring Status screen.
14. The Mirrored NetWare Partitions screen should be displayed. Press the **INSERT** key to display the Available Partitions screen.
15. Select the secondary partition that will mirror the primary partition.
16. When you mirror a device that includes a DOS partition to a device that does not include a DOS partition, the device with the DOS partition is 10 megabytes smaller than the device without the DOS partition. NetWare cannot mirror partitions of different sizes and displays a pop-up window that notifies you if the partitions are different sizes. To continue, press the **ESC** key and select *Yes* when NetWare requests permission to change the partition size.

17. If you have NetWare volumes already created on your hard drive subsystem, NetWare displays a pop-up window that notifies you of existing volumes. The volume must be deleted before NetWare can complete the mirroring procedure. If this pop-up window displays, press the **ESC** key to delete the NetWare volume and continue installation.



CAUTION: Deleting existing volumes on the server includes deleting all data in the volume. To save the data, discontinue NetWare installation, perform a complete backup, and restart NetWare installation.

18. When the partitions are mirrored, the Mirrored NetWare Partitions screen should display the primary partition first and the secondary partition second.
19. From the *Disk Options* menu, create and mount NetWare volumes.
20. Complete the NetWare installation by installing the System and Public files.

Your Fast-SCSI-2 subsystem is configured for NetWare drive mirroring, and NetWare System and Public files are installed. Continue your server configuration by installing the NetFlex Controller and loading NetFlex device drivers (see Chapter 4).

FOR NETWARE CONTROLLER DUPLEXING

This configuration requires either of the following hard drive controller combinations:

- Integrated Fast-SCSI-2 Controller and 32-Bit Fast-SCSI-2 Controller board
- Two 32-Bit Fast-SCSI-2 Controller boards



IMPORTANT: Before beginning installation, review the "Preinstallation Checklist" in Chapter 2 to ensure that you have completed the hardware configuration and the preparation for installing NetWare.

When configuring the Fast-SCSI-2 subsystem for controller duplexing under NetWare, perform the following steps.

1. Verify that EISA Configuration Utility recognizes both Fast-SCSI-2 Controllers, that the Controller Order Field for one Fast-SCSI-2 Controller is set to first, and that the Controller Order Field for the other Fast-SCSI-2 Controller is set to second.
2. Copy the *SCSI.EXE* file from the \SCSI subdirectory of the NetWare Programs from Compaq diskette to the \NW311 subdirectory in the server DOS partition.

NOTE: In this configuration procedure, the NetWare subdirectory in the server DOS partition is \NW311.

3. Enter the following from the DOS prompt. The *SCSI.EXE* file provides a series of *.NCF* files for COMPAQ hard drive subsystems.

```
SCSI
```

4. Copy the *SU001.NCF* file to a NetWare *STARTUP.NCF* file in the \NW311 subdirectory of the server DOS partition. This file loads the appropriate hard disk device driver when you start the server. For example:

```
COPY C:\NW311\SU001.NCF C:\NW311\STARTUP.NCF
```

5. From the \NW311 subdirectory, enter the following:

```
SERVER
```

6. Name the server and provide a unique internal network number.
7. From the NetWare prompt, enter the following to load *INSTALL.NLM*:

```
LOAD INSTALL
```

8. Verify that the NetWare *STARTUP.NCF* file includes the following **LOAD** statements for the Fast-SCSI-2 Controllers. This enables NetWare to load device drivers for the controllers when you start the server.

```
LOAD C:\NW311\CPQSXPT
LOAD C:\NW311\CPQS710
LOAD C:\NW311\CPQSDISK
```

9. From the Installation Options menu, select *Disk Options*.
10. Select *Available Disk Options*.
11. Select *Device #0* at the Available Disk Options menu.

12. Select *Create NetWare Partition* at the Partition Options menu.
13. The Partition Information screen displays. Press the **ESC** key to accept the information on the Partition Information screen.
14. At the "Create Partition?" prompt, select *Yes*. When you select *Yes*, NetWare creates a NetWare partition for Device #0.
15. When NetWare finishes creating the partition for Device #0, the Partition Options menu displays. Select *Return to Previous Menu* to repeat the procedure for the remaining SCSI hard drives.
16. Create partitions for each of the devices listed in the Available Disk Options menu.
17. From the Disk Options menu, select *Partition Tables*.
18. At the Available Disk Drives screen, note the slot number for each of the listed devices. You must know these slot numbers to duplex one device from the primary channel with one device from the secondary channel. For example, in the following display, Device #0 is attached to the Integrated Fast-SCSI-2 Controller in slot 8, and Device #2 is attached to the 32-Bit Fast-SCSI-2 Controller board in slot 6.

Device #0	(9B000)	CPQS710	Slot 8	COMPAQ	C2244
Device #1	(9B001)	CPQS710	Slot 8	COMPAQ	C2244
Device #2	(9B112)	CPQS710	Slot 6	COMPAQ	C2244
Device #3	(9B113)	CPQS710	Slot 6	COMPAQ	C2244

! **IMPORTANT:** In the screen display, the alphanumeric characters in parentheses (for example, 9B114) differentiate one hard drive from another. You can identify a particular hard drive by noting the last character (in this example, the character is 4), which represents the SCSI ID. If you set the SCSI IDs to match the drive bays in the COMPAQ ProSignia, you can easily identify and replace the hard drive in the event of a drive failure.

19. Press the **ESC** key to return to the Available Disk Options menu.
20. From the Available Disk Options menu, select *Mirroring*.
21. Select the primary partition from the Partition Mirroring Status screen. For example, you can select *Logical Partition #1*.

22. The Mirrored NetWare Partitions screen should be displayed with the selected partition and device number listed as shown below. Press the **INSERT** key to add a partition to the set and to display the Available Partitions screen.

```
In Sync -      NetWare 386 partition 1 on Device #0 (9B001)
```

23. Select the secondary partition that will duplex the primary partition. This partition must be attached to the other hard drive controller. For example, you can duplex Partition #1 on Device #0 with Partition #3 on Device #2.
24. When you duplex a device that includes a DOS partition to a device that does not include a DOS partition, the device with the DOS partition is 10 megabytes smaller than the device without the DOS partition. NetWare cannot mirror partitions of different sizes and displays a pop-up window that notifies you if the partitions are different sizes. To continue, press the **ESC** key and select *Yes* when NetWare requests permission to change the partition size.
25. If you have NetWare volumes already created on your hard disk, NetWare displays a pop-up window that notifies you of existing volumes. The volumes must be deleted before NetWare can complete the duplexing procedure. If this pop-up window displays, press the **ESC** key to delete the NetWare volume and continue installation.



CAUTION: Deleting existing volumes on the server includes deleting all data in the volume. To save the data, discontinue NetWare installation, perform a complete backup, and restart NetWare installation.

26. When the partitions are duplexed and resynchronized, the Mirrored NetWare Partitions screen displays the primary partition first and the secondary partition second, as shown below. Press the **ESC** key to return to the Partition Mirroring Status screen.

```
In Sync -      NetWare 386 partition 1 on Device #0 (9B000)
In Sync -      NetWare 386 partition 3 on Device #2 (9B113)
```

27. Verify that the two partitions are "mirrored" from the information on the Partition Mirroring Status screen.
28. Duplex any remaining devices as required.
29. From the *Disk Options* menu, create and mount NetWare volumes.

30. Continue the NetWare installation by installing the NetWare System and Public files.

Your Fast-SCSI-2 subsystem is configured for controller duplexing, and NetWare System and Public files is installed. Continue your server configuration by installing the NetFlex Controller and loading NetFlex device drivers (see Chapter 4).

CONFIGURING THE IDA-2 SUBSYSTEM

When configuring the IDA-2 subsystem in the COMPAQ ProSignia, the IDA-2 Controller uses the COMPAQ *CPQDA386.DSK* device driver for maximum performance. The *CPQDA386.DSK* device driver is in the \DRV_ARRAY\NW31X subdirectory of the NetWare Programs from Compaq diskette. Although the IDA-2 Controller also supports the Novell *ISADISK.DSK* device driver, the driver does not take advantage of the IDA-2 Controller's capabilities. Configuring an IDA-2 Controller with *ISADISK.DSK* can greatly reduce IDA-2 performance.



CAUTION: Do not load both the *CPQDA386.DSK* and *ISADISK.DSK* device drivers for a single IDA controller. If the hard drives are set up and volumes are created using *CPQDA386.DSK* and you load *ISADISK.DSK*, all data is lost.

NOTE: The COMPAQ TechNote for NetWare *COMPAQ IDA-2 Configuration for NetWare* provides detailed configuration, performance tuning, and management guidelines for the IDA-2 subsystem.

FOR NETWARE CONTROLLER DUPLEXING

The IDA-2 subsystem and COMPAQ ProSignia support a variety of fault tolerance methods including NetWare controller duplexing; however, NetWare controller duplexing is not recommended for a COMPAQ ProSignia PC Server configured with an IDA-2 subsystem. An IDA-2 controller duplexing configuration on the COMPAQ ProSignia provides a limited upgrade path for the growth of the server, because it supports a maximum of three drive array pairs. Controller duplexing requires two EISA expansion slots for the IDA-2 Controllers, a minimum of two drive array pairs, and a multiple of two drive array pairs. If you require controller duplexing for your COMPAQ ProSignia, use the Fast-SCSI-2 hard drive subsystem.

FOR COMPAQ DRIVE MIRRORING, DISTRIBUTED DATA GUARDING, DATA GUARDING, AND NO FAULT TOLERANCE

-
- ! **IMPORTANT:** Before beginning installation, review the "Preinstallation Checklist" in Chapter 2 to ensure that you have completed hardware configuration and preparation for installing NetWare.
-

When configuring the COMPAQ ProSignia and IDA-2 subsystem using the COMPAQ EISA Configuration Utility, perform the following as part of your server configuration:

1. Under the Drive Characteristics menu of the EISA Configuration Utility, you should see an option for three logical drives, as well as options for one or two logical drives. The IDA-2 Controller supports up to three logical drives. Select the desired number of logical drives and press the **ENTER** key.
2. The Fault Tolerance Selection menu should appear as follows. Select the desired method of fault tolerance.

No Fault Tolerance
 Data Guarding
 Distributed Data Guarding
 Drive Mirroring

NOTE: Distributed data guarding is available only for IDA-2.

3. When viewing and editing details in the EISA Configuration Utility, ensure that the Array Accelerator Status is enabled for each logical drive for the IDA-2 subsystem.
4. Ensure that NetWare is selected as the server operating system in the EISA Configuration Utility.

-
- ! **IMPORTANT:** When viewing and editing details in the EISA Configuration Utility, each logical drive includes information on the Array Striping Factor. When you select NetWare as the server operating system, the options for the Array Striping Factor are automatically configured.
-

5. Note the slot number of the IDA-2 Controller. NetWare requires the slot number in the hard disk device driver LOAD statement of the *STARTUP.NCF* file.
6. When you complete your server configuration, reboot the server.

Once you have completed the EISA configuration, perform the following to install NetWare:

1. At the DOS prompt, copy the IDA-2 Controller device driver *CPQDA386.DSK* from the NetWare Programs from Compaq diskette to the \NW311 subdirectory in the server DOS partition.

NOTE: In this configuration procedure, the NetWare subdirectory in the server DOS partition is \NW311.

2. From the DOS prompt, enter the following:

```
SERVER
```

3. Name the server and provide a unique internal network number.
4. From the NetWare prompt, load the device driver *CPQDA386.DSK* by entering the following:

```
C:\NW311\CPQDA386.DSK SLOT=[slot #]
```

5. From the NetWare prompt, enter the following to load *INSTALL.NLM*:

```
LOAD INSTALL
```

6. Create a NetWare *STARTUP.NCF* file and ensure that a LOAD statement similar to the following for *CPQDA386.DSK* is included in the *STARTUP.NCF* file. This enables NetWare to load the device driver when you start the server.

```
LOAD C:\NW311\CPQDA386.DSK SLOT=[slot # ]
```

7. Select *Disk Options* at the Installation Options menu and create the NetWare partition.
8. Create and mount NetWare volumes.
9. Continue the NetWare installation by installing the System and Public files.

Your IDA-2 subsystem is configured with the desired method of COMPAQ fault tolerance, and NetWare System and Public files are installed. Continue your server configuration by installing the NetFlex Controller and loading NetFlex device drivers (see Chapter 4).

CONFIGURING AN IDA-2 SUBSYSTEM AND A FAST-SCSI-2 SUBSYSTEM

! **IMPORTANT:** Before beginning installation, review the "Preinstallation Checklist" in Chapter 2 to ensure that you have completed the hardware configuration and the preparation for installing NetWare.

You can also configure a COMPAQ ProSignia with both an IDA-2 subsystem and a Fast-SCSI-2 subsystem. Before configuring the server, you must determine which controller will be used for the boot disk, and configure the boot disk controller as the primary controller using the EISA Configuration Utility.

To configure the IDA-2 Controller as the boot disk controller, configure the server as if the Fast-SCSI-2 subsystem did not exist. When you create the NetWare partition and volumes, NetWare recognizes the Fast-SCSI-2 drives and configures them as part of the NetWare partition.

To configure the Fast-SCSI-2 Controller as the boot disk controller, perform the following procedure while in the EISA Configuration Utility.

1. Execute the EISA Configuration Utility and ensure that the Fast-SCSI-2 Controller is configured as the primary controller.
2. Ensure that the Standard Interface for the IDA-2 Controller is configured as *DISABLED*.
3. Save the configuration and exit the EISA Configuration Utility.

When configuring the Fast-SCSI-2 subsystem and IDA-2 subsystem under NetWare, perform the following steps.

1. Copy the *SCSI.EXE* file from the \SCSI subdirectory of the NetWare Programs from Compaq diskette to the \NW311 subdirectory in the server DOS partition.

NOTE: In this configuration procedure, the NetWare subdirectory in the server DOS partition is \NW311.

2. Copy the IDA-2 Controller device driver *CPQDA386.DSK* from the \DRV_ARRAY\NW31X subdirectory of the diskette to the \NW311 subdirectory in the server DOS partition.

3. Enter the following from the DOS prompt. The *SCSI.EXE* file provides a series of *.NCF* files for COMPAQ hard drive subsystems.

```
SCSI
```

4. Copy the *SU002.NCF* file to a NetWare *STARTUP.NCF* file. The *STARTUP.NCF* file loads the appropriate hard disk device drivers for the IDA-2 Controller and for the Fast-SCSI-2 Controller when you start the server. For example:

```
COPY C:\NW311\SU002.NCF C:\NW311\STARTUP.NCF
```

5. From the DOS prompt, enter the following:

```
SERVER
```

6. Name the server and provide a unique internal network number.
7. From the NetWare prompt, enter the following to load *INSTALL.NLM*:

```
LOAD INSTALL
```

8. Verify that the NetWare *STARTUP.NCF* file includes the appropriate *LOAD* statement for the primary controller. This enables NetWare to load device drivers for the primary controller when you start the server. For example, the following *LOAD* statements are for the Fast-SCSI-2 Controller configured as the primary controller.

```
LOAD C:\NW311\CPQSXPT  
LOAD C:\NW311\CPQS710  
LOAD C:\NW311\CPQSDISK
```

9. Include the appropriate *LOAD* statement(s) for the secondary controller. This enables NetWare to load the device driver for the secondary controller when you start the server. For example, the following *LOAD* statement is for the IDA-2 Controller configured as the secondary controller.

```
LOAD CPQDA386.DSK SLOT=[slot # ]
```

11. From the Installation Options menu, select *Disk Options* and create the NetWare partition.
12. Select *Partition Tables* at the Available Disk Options menu.
13. Select *Device #0* at the Available Drives Menu.
14. Select *Create NetWare Partition* at the Partition Options menu.
15. At the "Create Partition?" prompt, select *Yes*. When you select *Yes*, NetWare creates a NetWare partition for the primary channel.

16. When NetWare finishes creating the primary partition, the Partition Options menu displays. Select *Return to Previous Menu* to repeat the procedure for the secondary channel.
17. Select *Device #1 COMPAQ IDA-2 Controller* at the Available Drives menu.
18. Select *Create NetWare Partition* at the Partition Options menu.
19. At the "Create Partition?" prompt, select *Yes*. When you select *Yes*, NetWare creates a NetWare partition for the secondary channel.
20. When NetWare completes the creation of the secondary partition, the Partition Options menu displays.
21. Press the **ESC** key to return to the Installation Options menu.
22. Select *Disk Options* from the Installation Options menu.
23. Create and mount NetWare volumes.
24. Continue the NetWare installation by installing the System and Public files.

Your Fast-SCSI-2 subsystem and IDA-2 subsystem are configured, and NetWare System and Public files are installed. Continue your server configuration by installing the NetFlex Controller and loading NetFlex device drivers (see Chapter 4).

USING *SYNCPTCH.NLM* TO RESYNCHRONIZE MIRRORED PARTITIONS

The *SYNCPTCH.NLM* is an NLM developed by Compaq that reduces the amount of time needed to resynchronize mirrored NetWare partitions. It also reduces CPU utilization during the resynchronization and remirroring process. Reduction in remirroring time and in CPU utilization is most apparent when you remirror large NetWare partitions or COMPAQ drive array subsystems that use the *CPQDA386.DSK* device driver.

The *SYNCPTCH.NLM* is in the `\DRV_ARRAY\NW31X` subdirectory on the NetWare Programs from Compaq diskette. The subdirectory also contains a README file (*SYNCPTCH.RDM* file) on the *SYNCPTCH.NLM*.

You can use the *SYNCPTCH.NLM* when you configure the COMPAQ ProSignia in the following fault tolerance configurations, regardless of the hard drive subsystem used:

- COMPAQ drive mirroring
- NetWare drive mirroring
- NetWare controller duplexing

For the best results, load the *SYNCPTCH.NLM* before any mirrored partition resynchronization begins. Since NetWare begins resynchronization when it detects partitions that are not synchronized, you can add the following LOAD SYNCPTCH statement to the *AUTOEXEC.NCF* file. This ensures that *SYNCPTCH.NLM* loads each time the server initializes.

```
LOAD [path] SYNCPTCH
```

Where *path* represents the partition, volume, and subdirectory of the location of the NLM. If you load the NLM from the DOS partition, include the drive and subdirectory. If you load the NLM from the NetWare partition, include the volume name and path.

You can also load the *SYNCPTCH.NLM* during mirror resynchronization to improve performance. The *SYNCPTCH.NLM* can improve performance of the remainder of the resynchronization process. Perform the following steps:

1. From the NetWare prompt, enter the following to load *INSTALL.NLM*:
LOAD INSTALL
2. At the Installation Options menu, select *Disk Options*.
3. At the Available Disk Options menu, select *Mirroring*.
4. Select each logical partition and press the **ENTER** key to view mirrored partitions. When you press the **ENTER** key, the Mirrored NetWare Partitions screen should display all mirrored devices and indicate whether they are "In Sync" or "Out of Sync."
5. Identify any partitions that are "Out of Sync" and note the associated device numbers.
6. Exit *INSTALL.NLM*.

7. From the NetWare prompt, enter the following to load *MONITOR.NLM*:

```
LOAD MONITOR
```
8. Select *Disk Information* from the main menu.
9. Select the device number that corresponds to the "Out of Sync" partition and deactivate the partition to halt resynchronization of the logical partition.
10. From the NetWare prompt, enter the following to load *SYNCPTCH.NLM*:

```
LOAD [path] SYNCPTCH.NLM
```

Where *path* represents the partition, volume, and subdirectory of the location of the NLM. If loading the NLM from the DOS partition, include the drive and subdirectory. If loading the NLM from the NetWare partition, include the volume name and path.
11. From the Disk Information option of *MONITOR.NLM*, reactivate the device.

With the *SYNCPTCH.NLM* loaded, the resynchronization process automatically continues from where the device was deactivated.

Once you have completed the hard drive subsystem configuration and installed NetWare System and Public files, continue server configuration by installing the NIC and load the NIC device drivers (see Chapter 4).



Chapter 4

COMPAQ 32-BIT NETFLEX CONTROLLER

The COMPAQ 32-Bit NetFlex Controller provides Ethernet and Token Ring (both 4-Mb/s and 16-Mb/s) support on the same controller. The NetFlex Controller comes "Ethernet-ready" with a plug-in COMPAQ DualSpeed Token Ring adapter module for 16/4 Token Ring support.

The Ethernet and Token Ring device drivers for the NetFlex Controller are included in the \NETWORK\NW31X subdirectory on the NetWare Programs from Compaq diskette.

CONFIGURING THE NETFLEX CONTROLLER BOARD

To configure the NetFlex Controller in the COMPAQ ProSignia, perform the following procedure.

1. Ensure that the NetFlex Controller is installed in the server.

NOTE: The NetFlex Controller is generally preinstalled in slot 7 of the COMPAQ ProSignia.

-
- ! **IMPORTANT:** If you are using the COMPAQ AUI to BNC Converter, attach it to the NetFlex Controller after you install the NetFlex Controller in the expansion slot.
-

2. Turn on the server with the COMPAQ System Configuration diskette in the primary diskette drive, and verify that the EISA Configuration Utility has added the NetFlex Controller to the system configuration. The selected topology (Ethernet or Token Ring) determines which settings appear in the system configuration.

For a NetFlex Controller configured for Ethernet, settings similar to the following are displayed:

Network Type...	Ethernet
Interrupt...	IRQ 11, Level Triggered
Interrupt Sharing...	Disabled
Network Speed...	10 Mbps
Network Media...	AUI (DB-15)

For a NetFlex Controller configured for Token Ring, setting similar to the following are displayed:

Network Type...	Token Ring
Interrupt...	IRQ 11, Level Triggered
Interrupt Sharing...	Disabled
Network Speed...	16 Mbps
Network Media...	Shielded Cabling

3. If you are installing multiple NICs, ensure that the NetFlex Controller is set to IRQ 11, Level-Triggered.

The device driver for the NetFlex Controller supports up to four unique interrupts. When you add a fifth NIC to the server configuration, the fifth NIC must share an interrupt with one of the other NICs. The following table shows the interrupts that the EISA Configuration Utility sets for a server with one IDA-2 Controller and five NetFlex Controllers.

NOTE: The interrupts in your configuration may vary, depending on the options installed in your server. In this scenario, an IDA-2 Controller uses IRQ 14.

Table 4-1
Interrupt Settings for Multiple NICs

For 1 to 4 NICs		For 5 NICs	
1st	IRQ 11 Level	1st	IRQ 11 Level
2nd	IRQ 10 Level	2nd	IRQ 11 Level
3rd	IRQ 9 Level	3rd	IRQ 9 Level
4th	IRQ 5 Level	4th	IRQ 5 Level
		5th	IRQ 3 Level

LOADING THE NIC DEVICE DRIVER

You can install the NetFlex Controller in either the DOS partition of your server or the NetWare partition; however, the DOS partition and all its files are not archived when you back up your server. Only the NetWare partition is archived. For this reason, install all NLMs in the NetWare partition of your server.

To load the NetFlex Controller device driver and then install the device driver in the NetWare partition of the server, perform the following procedure:

1. From the DOS prompt, copy *CPQETHNW.LAN* for Ethernet or *CPQTOKNW.LAN* for Token Ring from the \NETWORK\NW31X subdirectory of the NetWare Programs from Compaq diskette to the \NW311 subdirectory of the server DOS partition.

NOTE: In this configuration procedure, the NetWare subdirectory in the server DOS partition is \NW311.

2. From the \NW311 subdirectory, enter the following:

```
SERVER
```

3. Issue one of the following commands from the NetWare prompt.

For Ethernet:

```
LOAD C:\NW311\CPQETHNW SLOT=slot number  
FRAME=frame type
```

Where:

Slot number is the physical slot in which the board is installed.
Frame type is the network frame type. The default frame type for Ethernet is Ethernet_802.3, but the NetFlex Controller also supports Ethernet_802.2, Ethernet_II, and Ethernet_SNAP.

For Token Ring:

```
LOAD C:\NW311\CPQTOKNW SLOT=slot number  
FRAME=frame type
```

Where:

Slot number is the physical slot in which the board is installed.
Frame type is the network frame type. The default frame type for Token Ring is Token_Ring, but the NetFlex Controller also supports Token-Ring_SNAP.

4. Type the NetWare BIND command as follows to bind the IPX protocol to the NetFlex device driver.

For Ethernet:

```
BIND IPX TO CPQETHNW NET=net number
```

Where:

Net number is the number that you designate for that network segment. The net number should be the same number as other servers on the network segment, but it must be different from the server's internal network number that is identified at server startup.

For Token Ring:

```
BIND IPX TO CPQTOKNW NET=net number
```

Where:

Net number is the number that you designate for that network segment. The net number should be the same number as other servers on the network segment, but it must be different from the server's internal network number that is identified at server startup.

5. From a DOS workstation that is capable of logging into the server, login as SUPERVISOR.
6. Insert the NetWare Programs from Compaq diskette in the diskette drive of the DOS workstation.
7. Type the following commands to map the NetFlex Controller device drivers to the SYS volume of the NetWare partition on the server.

```
MAP F:=SYS:SYSTEM  
COPY A:\NETWORK\NW31X\*.LAN F:
```

NOTE: When you copy all *.LAN* files from the NetWare Programs from Compaq diskette, you copy both the Ethernet and Token Ring device drivers.

8. Log out of the workstation and complete the following steps from the server console.
9. From the NetWare prompt at the server console, enter the following to load *INSTALL.NLM*.

```
LOAD INSTALL
```

10. Modify the `LOAD` statement in the `AUTOEXEC.NCF` file to remove the path for the device driver, as shown below, to ensure that the NetFlex Controller loads from the NetWare partition each time the server is restarted.

```
LOAD CPQETHNW SLOT=4 FRAME=Ethernet_802.2
```

For example, the commands for a NetFlex Controller installed in slot 4 of a network server configured for Ethernet_802.2 should resemble the following example. The `LOAD` command indicates that the `CPQETHNW.LAN` device driver resides in the NetWare partition of the NetWare server.

```
LOAD CPQETHNW SLOT=4 FRAME=Ethernet_802.2
BIND IPX TO CPQETHNW NET=1A
```

The device driver installation for the NetFlex Controller is complete. Your server should be able to communicate with other devices on the network.

VIEWING NIC CUSTOM STATISTICS

The NetFlex Controller and device drivers for both Token Ring and Ethernet provide `MONITOR.NLM` and the COMPAQ Server Manager/R with custom statistics that allow you to identify NIC or network problems. These statistics are explained in the following sections.

ETHERNET

`MONITOR.NLM` and COMPAQ Server Manager/R display Ethernet NetFlex custom statistics to help you identify NIC or network problems. `MONITOR.NLM` displays general NIC statistics from NetWare. You can view these from the DOS prompt or from the Remote Console in Server Manager/R. These statistics can help you evaluate the server NIC status. The Ethernet NetFlex custom statistics are as follows:

- **Collisions** - Number of packet collisions that have occurred since server startup. Packet collisions occur regularly during normal operations.
- **FCS Errors** - Number of received frames with frame-check sequence errors.
- **Alignment Errors** - Number of packets that were received with alignment errors. Alignment errors occur when the NIC receives packets that do not have an integral number of bytes in length.

- **Deferred Transmissions** - Number of packets that were delayed during a transmission attempt due to a busy physical network.
- **Excessive Collisions** - Number of packets that were not transmitted because the number of attempts exceeded 16.
- **Late Collisions** - Number of times a collision has been detected.
- **Carrier Sense Errors** - Number of times that the carrier sense signal was not asserted during transmission. This indicates a loss of a connection or a cable problem.
- **Invalid Packets Received** - Number of packets that the NIC device driver received but cannot pass to the protocol stacks. Most invalid packets are broadcast packets intended for other devices. For example, if a NIC device driver is configured to receive an Ethernet_802.3 frame type, then the device driver designates all received Ethernet_802.2 frames invalid.

Most Ethernet NICs have device drivers that provide *MONITOR.NLM* with similar custom statistics. If you install an Ethernet NIC that does not provide custom statistics, you may not be able to gather this information.

TOKEN RING

Use *MONITOR.NLM* or COMPAQ Server Manager/R for identifying potential NIC problems on the server. *MONITOR.NLM* displays general NIC statistics from NetWare. You can view these either from the DOS prompt or from the Remote Console icon in COMPAQ Server Manager Facility/R

MONITOR.NLM and COMPAQ Server Manager/R also display custom statistics for the NetFlex Controller (device driver *CPQTOKNW.LAN*) to identify problems with the Token Ring NetFlex Controller. These custom statistics provide the following information:

- **Broadcast Packets Received** - Number of broadcast packets received since the device driver was loaded. A broadcast packet is a packet that every station on the physical network receives. This statistic is useful in identifying when the server receives a large number of broadcast packets from a workstation, which can indicate a defective workstation NIC.

- ***Multicast Packets Received*** - A diagnostic tool that allows you to ensure that the NIC is configured to receive multicast frames. A multicast packet is a one that a group of stations on the network receives. This counter represents the number of packets received that have a functional destination address. Although Token Ring does not really support "multicast" packets, the custom statistics use the term, because Novell uses this terminology in the device driver specification.
- ***Invalid Packets Received*** - Number of packets that the device driver receives, but does not understand. Most invalid packets are broadcast packets intended for other devices. For example, if a device driver is configured to receive a Token_Ring frame type, then all Token Ring_SNAP frames are considered invalid.
- ***Packets Discarded*** - Number of packets that are discarded at the device driver level, including invalid packets and broadcast packets that the device driver has transmitted. In a NetWare environment, transmitting stations discard their own broadcast packets, because the device driver must not pass its own broadcasts up through the protocol stacks.
- ***Transmit Packets Queued*** - One of the most useful statistics provided for Token Ring. It indicates the number of times that the protocol stack attempts to transmit a packet, and the device driver cannot transmit the packet. This occurs when the system processor processes packets faster than the NIC can send them. The Transmit Requests Queued statistic can provide information as to the location of system bottlenecks. If a large percentage of packets is queued and not transmitted, this may indicate a bottleneck at the server NIC or on the physical network.
- ***Line Errors, Burst Errors, ARI/FCI Errors, Lost Frame Errors, Frame Copied Errors, Token Errors*** - Called "soft errors." Soft errors do not usually affect the operation of the ring, but a large number of soft errors can affect network performance. If any of these statistics equals more than 2 percent of the total frames received or transmitted, this usually indicates a problem with the NIC or the physical network.
- ***Receive Congestion Errors*** - Represents a condition that occurs when the NIC receives a packet, but cannot buffer it. The packet is then dropped. This condition can occur if more packets are received than the system processor can process.

- ***DMA Bus Errors*** and ***DMA Parity Errors*** - Diagnostic counters that indicate the number of errors that occur when the NIC attempts to bus master data to the system processor. Under normal conditions, these counters should never rise; therefore, an increase in these counters can indicate a defective NIC. If this happens, replace the NIC.

Most Token Ring NICs have device drivers that provide *MONITOR.NLM* with similar custom statistics. If you install a Token Ring NIC that does not provide custom statistics, you may not be able to gather this information.

Chapter 5

CONFIGURATION OF ADDITIONAL SCSI DEVICES

When you configure a server with hard drives and tape drives on multiple SCSI buses, some applications require a method for identifying the SCSI bus that should be used to transmit commands. Most programs, such as tape backup utilities, use the Advanced SCSI Programming Interface (ASPI). These programs use an ASPI host number to identify the SCSI bus that should be used to send the command. The *CPQSASPI.NLM* device driver from Compaq provides ASPI support by assigning ASPI host numbers to all configured SCSI buses.

Cheyenne ARCserve v4.0, a client-server tape backup utility, provides automated backup and restore services for NetWare v3.x networks and COMPAQ tape drives. It requires the ASPI programming interface for servers with multiple SCSI buses.

This chapter provides guidelines for configuring your server for ASPI support. It discusses ASPI support for multiple SCSI buses, including how to change the default order for initialization of multiple SCSI buses. It also describes circumstances that may require you to change the default order for initialization of multiple SCSI buses.

NOTE: When you configure low-throughput devices, such as tape drives, on the same SCSI bus as high-throughput devices, such as the Fast-SCSI-2 hard drives, the low-throughput devices do *not* affect the performance of the high-throughput devices. Each SCSI device negotiates its own throughput on the SCSI bus.

ASPI SUPPORT CONFIGURATION

To install the COMPAQ ASPI programming interface, perform the following steps.

1. Enter the following command at the NetWare prompt to enable the ASPI device driver:

```
LOAD C:\CPQSASPI.NLM
```

2. Enter the following to load *INSTALL.NLM*.

```
LOAD INSTALL
```

3. Verify that the *AUTOEXEC.NCF* file includes the following command line. This command line loads the ASPI driver each time the server is started.

```
LOAD C:\CPQSASPI.NLM
```

! **IMPORTANT:** If you are loading Cheyenne ARCserver, ensure that *CPQSASPI.NLM* loads before *ARCserve.NLM*.

You can verify that the NLM loads properly by bringing down the server and restarting it. The ASPI driver should automatically load when you restart the server.

ASPI SUPPORT FOR MULTIPLE SCSI DEVICES

Applications that use the ASPI driver to send commands to a SCSI device, such as a tape drive, use the ASPI host number to specify the appropriate SCSI bus for sending the command. If a server is configured for one SCSI bus, the ASPI host number for that SCSI bus is "0." If a server is configured for multiple SCSI buses, *CPQSASPI.NLM* assigns an ASPI host number as each SCSI bus is initialized.

CPQSASPI.NLM assigns ASPI host numbers in the order in which the SCSI-2 interface module initializes the SCSI buses in the server. By default, *CPQS710.DSK* device driver begins with slot 1 and ends with slot 8, which contains the Integrated Fast-SCSI-2 Controller. (EISA Configuration Utility configures it as residing in slot 8.) If the server includes multiple SCSI buses, the Integrated Fast-SCSI-2 Controller loads last, with a "non-0" ASPI host number.

Some devices, such as tape drives, support only ASPI host number "0," and if the device is attached to a SCSI bus with an unsupported ASPI host number, the device does not function. For example, if you configure a COMPAQ ProSignia with the Integrated Fast-SCSI-2 Controller, Fast-SCSI-2 Controller board, and a tape drive that only supports ASPI host number 0, the tape drive must use the Fast-SCSI-2 Controller board, because it initializes first with ASPI host number 0. Otherwise, to configure the tape drive to use the Integrated Fast-SCSI-2 Controller, you must ensure that the Integrated Fast-SCSI-2 Controller initializes first.

NOTE: When you configure low-throughput devices, such as tape drives, on the same SCSI bus as high-throughput devices, such as the Fast-SCSI-2 hard drives, the low-throughput devices do *not* affect the performance of the high-throughput devices. Each SCSI device negotiates its own throughput on the SCSI bus.

You can change the default order in which the Fast-SCSI-2 Controllers initialize by specifying the slot number in the LOAD command in the *STARTUP.NCF* file for each controller. For example:

```
LOAD CPQS710.DSK SLOT=8  
LOAD CPQS710.DSK SLOT=3
```

In this example, an Integrated Fast-SCSI-2 Controller resides in slot 8, and a Fast-SCSI-2 Controller board resides in slot 3. To ensure that the Integrated Fast-SCSI-2 Controller initializes first, place the LOAD statement for the Integrated Fast-SCSI-2 Controller before the LOAD statement for the Fast-SCSI-2 Controller board in the *STARTUP.NCF* file. You can then add a tape drive that supports ASPI host number 0 to the Integrated Fast-SCSI-2 Controller bus.

Chapter 6

PERFORMANCE CONSIDERATIONS

This chapter discusses analyzing and tuning your COMPAQ ProSignia for optimum performance in the NetWare environment. Tuning your server may only require changing the value of a NetWare SET parameter, or it may require adding hardware components and rebalancing the server workload.

NOTE: The COMPAQ TechNote for NetWare *Performance Management in a NetWare v3.11 Environment* provides in-depth information on server performance tuning. It includes performance tuning checklists and troubleshooting quick reference charts.

SYSTEM MEMORY

NetWare dynamically allocates system memory to "memory pools" in the server for specific tasks, such as running NLMs. How NetWare uses these memory pools can impact server performance.

NetWare allocates system memory to a large memory pool called the Cache Buffers pool. The Cache Buffers pool is the main memory pool from which other memory pools receive memory. It dynamically, or manually through SET parameters, allocates system memory to these other memory pools for specific functions. Depending on the type of request, NetWare allocates the minimum amount of system memory to the appropriate memory pool, allowing these pools to grow upon demand.

The remaining system memory in the Cache Buffers pool is used for disk caching, an important part of the disk I/O process. When NetWare caches the written data, the cache, rather than the physical drives, can then satisfy I/O requests without having to access the disk.

The size of the Cache Buffers pool depends on the following:

- Total amount of system memory.
- Amount of system memory allocated to other memory pools.
- Amount of system memory needed for disk caching.

Too little system memory can significantly impact server performance. Novell provides the following system memory formula for estimating the minimum memory requirements for a NetWare server, based on total NetWare volume space. Use this formula to determine the minimum amount of system memory needed for your server.

$$\frac{(0.023 * \text{total MB of volume})}{\text{volume block size in KB}} = \text{system memory} + 4 \text{ MB} = \text{Total}$$

NOTE: Use 0.032 as the constant for this formula when configuring volumes for Name Space support. For more information, refer to the NetWare documentation.

This calculation provides the minimum starting point for your server memory requirements; however, the number of users and the types of applications that run on the server also affect your server's performance.

Once your server is configured and operating, monitor performance using COMPAQ INSIGHT Manager, COMPAQ Server Manager/R, or *MONITOR.NLM*. Ensure that the Cache Buffers statistic in the *MONITOR.NLM* Information menu remains above 70 percent of the Total Cache Buffers value. If the Cache Buffers statistic falls below 70 percent of the Total Cache Buffers value, add system memory to the server to maintain optimum performance.

NOTE: Because the server system memory is closely tied to the hard drive subsystem in the NetWare environment, analyze the system memory and hard drive subsystem together when tuning server performance.

HARD DRIVE SUBSYSTEM

Since disk I/O comprises a major part of daily network operations, the hard drive subsystem is one of most important performance factors in the NetWare environment. In a typical NetWare environment, a large part of the server activity is hard drive access, including data retrieval and storage.

The following sections discuss optimizing the following hard drive subsystems for the COMPAQ ProSignia:

- Fast-SCSI-2
- IDA-2

FAST-SCSI-2 SUBSYSTEM

Four factors affect the disk I/O performance of the Fast-SCSI-2 subsystem.

- Device driver efficiency
- Volume block size and cache buffer size
- Using multiple drives
- Read-after-write verification

The following sections discuss how the Fast-SCSI-2 subsystem addresses these factors and how you can optimize your server to take full advantage of the Fast-SCSI-2 subsystem performance.

Device Driver Efficiency

To ensure the best possible performance, always use the latest version of the hard disk device driver for your hard drive subsystem. Most hard drive subsystems are shipped with device drivers written specifically for the subsystem technology. The Fast-SCSI-2 device driver includes performance enhancement features that take advantage of the Fast-SCSI-2 subsystem, such as tagged command queuing and scatter/gather.

The Fast-SCSI-2 device driver is in the \SCSI subdirectory of the NetWare Programs from Compaq diskette. To access the appropriate device driver, you must copy the *SCSI.EXE* file to your hard drive and execute it. The self-extracting *SCSI.EXE* file contains a set of sample *STARTUP.NCF* files. Each of these files is a multilayered Fast-SCSI-2 device driver that includes the following NLMs:

- *CPQS710.DSK*
- *CPQSXPT.DSK*
- *CPQSDISK.DSK*

NOTE: For Fast-SCSI-2 configuration information, refer to Chapter 3 of this COMPAQ TechNote.

Fast-SCSI-2 Volume Block Size and Cache Buffer Size

When configuring COMPAQ PC servers, setting the NetWare volume block size is one of the few exceptions to the rule that NetWare default settings provide adequate performance. The NetWare default volume block size is 4 Kbytes. When configuring the Fast-SCSI-2 subsystem, increasing the volume block size to 8 Kbytes can substantially increase disk I/O performance.

As you increase the volume block size, however, you increase the potential for wasted disk space if your environment primarily consists of files that are smaller than the volume block size. For example, if you set the volume block size to 8 Kbytes, a 4-Kbyte file uses only half of the volume block, wasting the remaining space.

When analyzing your server, note the size of the data files for the applications that your server runs. Typical office productivity software stores files that include formatting, graphics, and fonts, as well as text. These files generally exceed 8 Kbytes. If your server runs in a resource-sharing environment and you do not have access to file-size information, use an 8-Kbyte volume block size as a starting point. This gives you a higher level of performance without wasting disk space when running today's common applications.



CAUTION: You set the volume block size when you create each volume. Changing it can result in loss of all data in that volume. Before changing the volume block size, perform a complete backup of the volume.

Once you define the volume block size, set the cache buffer size to be equal to or less than the volume block size. Matching the volume block size and the cache buffer size is optimal. For example, if you select an 8-Kbyte volume block size, set the cache buffer size to 8192 (8 Kbytes). If you set the volume block size to 8 Kbytes and the cache buffer size to 4096 (4 Kbytes), each I/O request requires two cache operations.



IMPORTANT: If the cache buffer size is larger than the volume block size, NetWare cannot mount the volume.

Use the following table to set both the volume block size using *INSTALL.NLM* and the appropriate cache buffer size using the NetWare SET parameter SET CACHE BUFFER SIZE.

Table 6-1
Volume Block and Cache Buffer Size Recommendations

Volume Block Size (Kbytes)	Cache Buffer Size
4	4096 (Provides best use of storage)
8	8192 (Provides best balance between performance storage in most environments)
16	16384 (Provides best performance)
32	16384 (Provides best performance)
64	16384 (Provides best performance)

NOTE: Highlighted row shows recommended size.

Include the SET CACHE BUFFER SIZE parameter in the *STARTUP.NCF* file as follows, so it loads automatically when the server initializes:

```
SET CACHE BUFFER SIZE = 8192
```

- IMPORTANT:** If you configure multiple volumes with different volume block sizes, set the cache buffer size *no larger than the smallest* volume block size. If the volume block size is smaller than the cache buffer size, NetWare cannot mount the volume.

Figure 6-1 shows results of a performance comparison between the different volume block sizes during *write* operations. Figure 6-2 shows performance results during *read* operations. Although the performance returns are significant when increasing the volume block size from 4 Kbytes to 8 Kbytes, the performance returns diminish as the volume block size exceeds 8 Kbytes.

NOTE: The actual performance gains for your server will depend on your particular environment.

Figure 6-1
WRITE Test Results - Volume Block Size Comparison

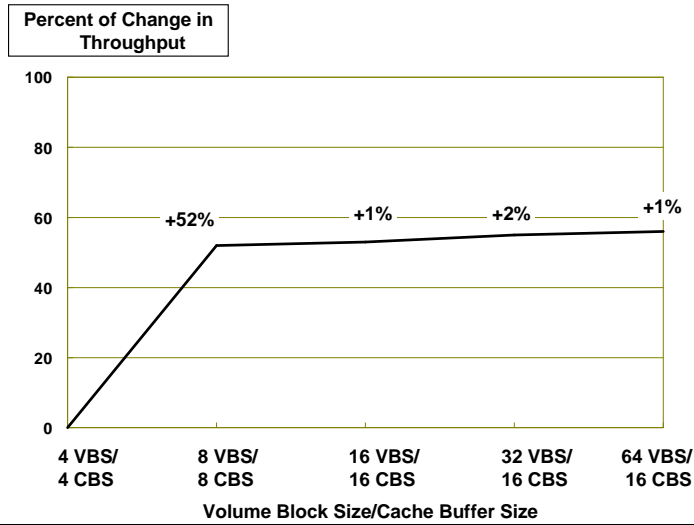
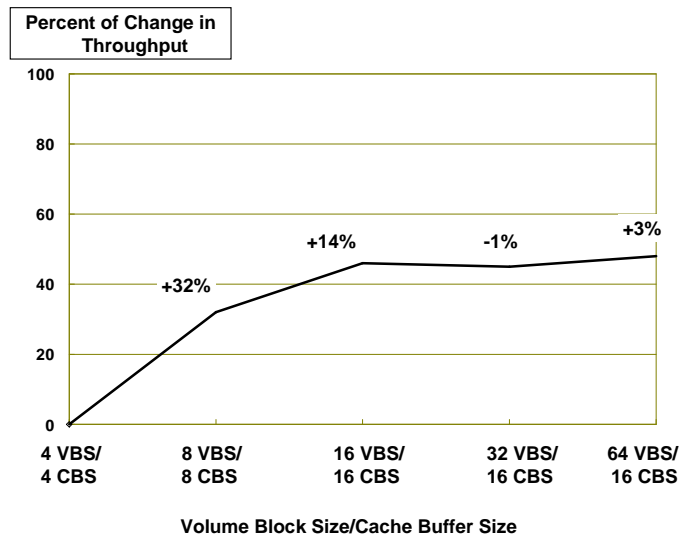

Figure 6-2
READ Test Results - Volume Block Size Comparison



Using Multiple Drives

Compaq integration testing indicates that there is some performance improvement as you add drives to the server. This performance improvement is due to the following Fast-SCSI-2 subsystem features:

- High-performance hardware
- Fast-SCSI-2 device driver
- Tag command queuing
- Interleaved data transfers

As the PC hardware industry develops, COMPAQ server hardware becomes more efficient and powerful. Current Fast-SCSI-2 hard drives show improved average access times (11 milliseconds for the 550-megabyte and 1050-megabyte drives and 14 milliseconds for the 330-megabyte drive) as well as disk rotation speeds (5,400 rotations per minute for 550-megabyte and 1050-megabyte drives and 4,400 rotations per minute for 330-megabyte drive). The Fast-SCSI-2 Controller (both Integrated and Controller board) provides 32-bit bus-master operations and includes a data transfer rate of up to 10 megabytes per second. The mechanical efficiency of the hard drive and the intelligent design of the controller provide a high-performance subsystem.

! **IMPORTANT:** When you configure low-throughput devices, such as tape drives, on the same SCSI bus as high-throughput devices, such as Fast-SCSI-2 hard drives, the low-throughput devices do *not* affect the performance of the high-throughput devices. Each SCSI device negotiates its own throughput on the SCSI bus for optimum throughput.

The COMPAQ device driver for the Fast-SCSI-2 subsystem provides an efficient interface between hard drive and operating system, including scatter/gather. Scatter/gather combines multiple requests and reduces the overhead that results from negotiation (such as location of data, availability of the device, and access to the SCSI bus) between controller and SCSI device, so the controller and SCSI device negotiate once for several requests, rather than once for each request. Scatter/gather can provide up to 20 percent performance improvement in disk I/O throughput.

Tagged command queuing allows the hard drive to queue and sort multiple commands, and then execute multiple commands simultaneously. This ensures that at least one request is queued at all times, so when the hard drive completes one request, it immediately processes the next request.

The benefits of configuring multiple drives are most apparent when multiple Fast-SCSI-2 hard drives are used in configurations that support interleaved data transfers (also called command overlapping). The hard drives receive requests for data and disconnect from the SCSI bus while they retrieve the data. As the drive processes one request, the device driver can issue other requests to other hard drives.

SERVER PLANNING CONSIDERATIONS

When planning your server configuration, you can increase your server performance by configuring multiple hard drives to obtain the same amount of disk space. Using smaller, multiple drives, however, limits the total amount of internal disk capacity. You must consider the trade-off between throughput performance and total internal disk capacity.

Compaq integration testing, using a COMPAQ ProSignia with an 8-Kbyte volume block size, 8-Kbyte cache buffer size, and a single NetWare volume with multiple drives, indicated that adding hard drives to the server increased the throughput performance. The most dramatic increase occurred when the second hard drive was added to the server, with additional drives affecting the performance less dramatically.

Configuring multiple hard drives, however, to improve server performance and acquire the same amount of disk space limits the total internal disk capacity. For example, if you are planning a server with a minimum of 1 gigabyte of hard disk space, to achieve better performance you can plan your server for two 550-megabyte hard drives, rather than a single 1050-megabyte hard drive. Using seven 550-megabyte hard drives (the maximum number of hard drives supported in the COMPAQ ProSignia) provides only 3.85 gigabytes of available internal disk space. You can obtain approximately the same amount of disk space (4.2 gigabytes) by configuring four 1050-megabyte hard drives, with available hard drive bays for future hard disk expansion.

Table 6-2 illustrates the trade-off between performance and capacity.

Table 6-2
Hard Drive Performance and Capacity Comparison
for 1 Gigabyte of Disk Space

Hard Drive Configuration	Relative Performance	Total Internal Expansion (Maximum 7 Devices)
One 1050-MB	Good	7.35 GB (Provides maximum potential expandability)
Two 550-MB	Better	3.85 GB (Provides better performance, but with limited potential expandability)

Additional testing compared the performance of a single volume for each physical drive to the performance of a single volume spanning multiple drives. The test results indicated that there is little performance advantage to configuring multiple volumes for your subsystem versus configuring a single volume to span multiple drives. Your decision on the number of volumes should depend on your environment and user needs.

SERVER UPGRADE CONSIDERATIONS

When upgrading your server from a single-drive configuration, you can add a second hard drive to increase throughput performance substantially. For example, when upgrading a COMPAQ ProSignia Model 486DX2/66-330, you can add a second 330-megabyte hard drive for better throughput performance. Since you can configure hard drives of different types and sizes on the same SCSI bus, you can use drives with higher RPMs and faster access times to provide even better performance.

When adding hard drives to your server, ensure that your server has enough system memory to support the total amount of disk space. For example, 660 megabytes of disk space requires a minimum of 6 megabytes of system memory, and 1 gigabyte of disk space requires a minimum of 8 megabytes of system memory.

NOTE: The "System Memory" section of this chapter includes the formula for calculating the minimum amount of required system memory.

Read-After-Write Verification

In the Fast-SCSI-2 subsystem, read-after-write verification is supported at the hardware level only. The COMPAQ Fast-SCSI-2 device driver disregards the NetWare SET ENABLE DISK READ AFTER WRITE VERIFY parameter in favor of performing this task at the hard drive subsystem level.

-
- **IMPORTANT:** Read-after-write verification, whether it is hardware-based or software-based, is independent of the Hot Fix Redirection feature of NetWare. If read-after-write verification is disabled, the NetWare Hot Fix feature remains enabled.
-

The performance impact of read-after-write verification is significant. The default setting for read-after-write verification is *disabled*. Enabling read-after-write verification yields about a 50 percent decrease in throughput. Leaving it disabled is recommended for the following reasons:

- Performance impact
- Built-in Fast-SCSI-2 intelligence
- Existing NetWare Hot Fix Redirection feature

Most available hard drive subsystems, including the Fast-SCSI-2 subsystem and the IDA-2 subsystem, have "built-in" intelligence to determine if a write operation completes successfully. If the operation does not complete successfully, the device driver and NetWare flag the sector on the disk as faulty and remap the sector to an available sector in the Hot Fix Redirection Area. Since these hard drive subsystems include this "built-in" intelligence, and since NetWare provides the Hot Fix Redirection feature, the read-after-write verification process becomes unnecessary.

The *hardware* read-after-write verification capability is included in the Fast-SCSI-2 subsystem to support NetWare compatibility. You can enable read-after-write verification by using either of the following methods.

- Using the `-V` parameter when you load the *CPQSDISK.DSK*
- Using *MONITOR.NLM*

The text file *PRO_SIG.RDM* on the NetWare Programs from Compaq diskette provides information for enabling hardware read-after-write verification.

-
- ! **IMPORTANT:** Both of these methods enable *hardware* read-after-write verification via the hard disk device driver. They do not enable the NetWare SET ENABLE DISK READ AFTER WRITE VERIFY parameter.
-

IDA-2 SUBSYSTEM

The IDA-2 subsystem includes many features that allow high-throughput performance in heavily loaded networks. A multithreaded device driver, Array Accelerator caching, and built-in fault tolerance allow the IDA-2 subsystem to provide reliable, efficient I/O service to network users.

Several factors affect the disk I/O performance of the IDA-2 subsystem.

- Volume block size and cache buffer size
- Striping alignment
- Method of fault tolerance
- Device driver efficiency
- Read-after-write verification

The following sections discuss how the IDA-2 subsystem addresses these factors and how you can optimize your server to take full advantage of the IDA-2 subsystem performance.

NOTE: Refer to the COMPAQ TechNote for NetWare *COMPAQ IDA-2 Configuration for NetWare* for detailed configuration, performance, and server management information for the IDA-2 subsystem.

IDA-2 Volume Block Size and Cache Buffer Size

When configuring your COMPAQ ProSignia, setting the NetWare volume block size is one of the few exceptions to the rule that the NetWare default settings provide adequate performance. The NetWare default volume block size is 4 Kbytes; however, when implementing an IDA or an IDA-2 subsystem, you can improve disk I/O performance by modifying the NetWare volume block size to match the drive array striping factor.

In the NetWare environment, the striping factor for the IDA-2 subsystem is 16 sectors (8 Kbytes). For optimal performance, set the volume block size for the IDA-2 subsystem to 8 Kbytes. Increasing the volume block size to 8 Kbytes can increase hard drive subsystem performance.

As you increase the volume block size, however, you increase the potential for wasted disk space if your environment primarily consists of files that are considerably smaller than your volume block size. For example, some environments generate many small text files (less than 8 Kbytes). If you set the volume block size to 8 Kbytes, a 2-Kbyte file uses only a small portion of the volume block, wasting the remaining 6 Kbytes.

When analyzing your server, note the directories containing data files for the application types that your server runs. Typical office productivity software stores information on formatting, graphics, and fonts, as well as text, in a single file that generally exceeds 8 Kbytes. If your server runs in a resource-sharing environment and you do not have access to file-size information, use an 8-Kbyte volume block size as a starting point. The 8-Kbyte volume block size gives you a higher level of performance without wasting disk space when running today's common applications.

Refer to Table 6-1 when setting the volume block size from *INSTALL.NLM* and when setting the cache buffer size using the *SET CACHE BUFFER SIZE* parameter.



CAUTION: You set the volume block size when you create each volume. Once you set the volume block size, changing it may result in loss of all data in that volume. Perform a complete backup of the volume, delete the volume, create a new volume with a new volume block size, then restore the data to the new volume.

Striping Alignment

When configuring your IDA-2 subsystem, you can modify the size of the Hot Fix Redirection Area to improve performance of your drive array subsystem by ensuring that the NetWare volume blocks align with the drive array striping factor. If you accept the system default and do not align them, the NetWare volume blocks, which immediately follow the Hot Fix Redirection Area on the drive, may cross the stripe boundaries. A significant number of write requests crossing the stripe boundaries results in decreased performance.

Figure 6-3 illustrates the effect of aligned volume blocks and array striping factor and the effect of volume blocks that cross the stripe boundaries.

Align the volume blocks and striping factor during NetWare installation. Select *Create NetWare Partition* from the Partition Options menu in *INSTALL.NLM* and specify an *even* number of Hot Fix Redirection Area blocks.

NOTE: For detailed information on the IDA-2 subsystem, refer to the COMPAQ TechNote for NetWare *COMPAQ IDA-2 Configuration for NetWare*.



CAUTION: Before making any changes to the size of the Hot Fix Redirection Area, always perform a complete backup. Changing the size may destroy existing data on the volume.

Figure 6-3
Effect of Striping Alignment and Misalignment

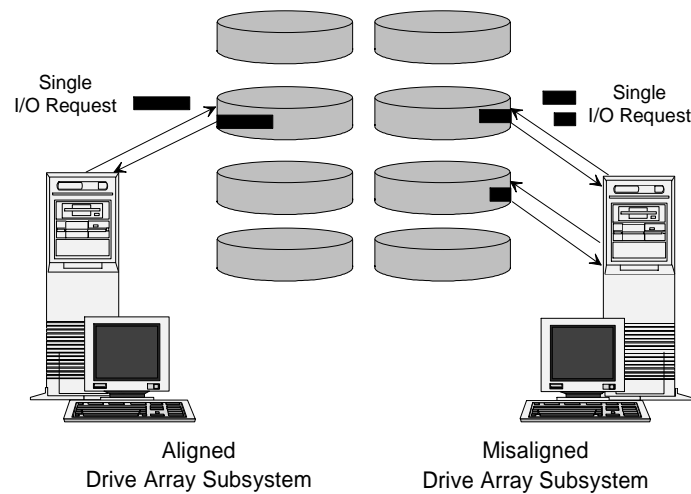

With large-volume hard drive subsystems (more than 2 gigabytes of disk space), the Hot Fix Redirection Area can become larger than necessary. For example, 2 percent of 7.35 gigabytes of disk space equals approximately 147 megabytes of Hot Fix Redirection Area. For many implementations, 147 megabytes of Hot Fix Redirection Area may be excessive. You can resize the Hot Fix Redirection Area to accommodate a more practical amount of disk space.

The IDA-2 subsystem also includes Dynamic Sector Repairing, a hardware feature that checks the disk for faulty sectors and remaps them. Considering Dynamic Sector Repairing and the number of large-volume hard drive subsystems that are currently available, resizing the Hot Fix Redirection Area can save disk space.



CAUTION: Before changing the size of the Hot Fix Redirection Area, always perform a complete backup. Changing the size may destroy any existing data on the volume.

Method of Fault Tolerance

The method of fault tolerance that you configure for your network server (drive mirroring, controller duplexing, distributed data guarding, or data guarding) can affect your network server performance.

If your network server performance is unacceptable after you have tried other server performance corrective measures, review the method of fault tolerance while considering the following points:

- In a read-intensive environment, data guarding and distributed data guarding are cost-effective choices, because they require less disk space to duplicate the data on the drive array.
- Although NetWare controller duplexing and COMPAQ drive mirroring use more disk space, they also provide enhanced performance by using split seek operations during read operations. Split seeks allow the IDA-2 Controller to alternate read operations between the primary drive array and the secondary drive array. The IDA-2 Controller can service read requests using the drive array that is available to provide the service, rather than using a single drive array to service all requests.

Device Driver Efficiency

Since all I/O requests pass through the hard disk device driver, the device driver plays an important role in server performance. COMPAQ provides a multithreaded device driver for the IDA-2 subsystem (*CPQDA386.DSK*) to take advantage of COMPAQ drive array technology.

The multithreaded capabilities of the *CPQDA386.DSK* device driver allow it to service concurrent requests. To support the *CPQDA386.DSK* device driver, the IDA-2 Controller uses a memory structure that allows the device driver to send requests to the hard drives and receive data from the hard drives simultaneously. The IDA-2 Controller can also post multiple requests to system memory. Handling multiple requests provides additional performance in network environments with heavy I/O activity.

-
- ! **IMPORTANT:** To ensure maximum I/O performance, always use *CPQDA386.DSK* when configuring your IDA-2 subsystem. NetWare provides a generic device driver (*ISADISK.DSK*) as part of the operating system for most non-array, non-SCSI subsystems; however, the *ISADISK.DSK* device driver provides only minimal disk I/O performance for drive array subsystems. Do not use *ISADISK.DSK* with the IDA-2 subsystem.
-

Read-After-Write Verification

The COMPAQ ProSignia supports read-after-write verification at the hardware level only, using a COMPAQ hardware feature called Dynamic Sector Repairing. The IDA-2 device driver disregards the NetWare SET ENABLE DISK READ AFTER WRITE VERIFY parameter in favor of performing Dynamic Sector Repairing at the IDA-2 subsystem level. This offloads the verification task from the operating system to the hardware.

When you configure the IDA-2 Controller for a *hardware* method of fault tolerance (such as COMPAQ drive mirroring, distributed data guarding, or data guarding), the system automatically enables Dynamic Sector Repairing as a background task. While the IDA-2 Controller waits for I/O requests, it performs read and write operations to disk sectors and remaps the faulty sectors. Dynamic Sector Repairing works much like the NetWare Hot Fix Redirection feature, but it is transparent to NetWare. Although the Hot Fix Redirection feature is still enabled under NetWare, the Hot Fix Redirection Area is used only when the hard drive runs out of spare sectors for Dynamic Sector Repairing.

When you configure the IDA-2 Controller for a *software* method of fault tolerance (such as NetWare drive mirroring or controller duplexing), the system *does not enable* Dynamic Sector Repairing. However, the hard drive subsystem and the Hot Fix Redirection feature provide sector remapping. The IDA-2 subsystem includes "built-in" intelligence to determine if a write operation completes successfully. If the operation does not complete successfully, the device driver and NetWare flag the sector on the disk as faulty and remap the sector to an available sector in the Hot Fix Redirection Area. Since these hard drive subsystems include this "built-in" intelligence that works with the Hot Fix Redirection feature, the read-after-write verification process becomes unnecessary.

-
- ! **IMPORTANT:** Read-after-write verification, whether it is hardware-based or software-based, is independent of the Hot Fix Redirection feature of NetWare. If read-after-write verification is disabled, the NetWare Hot Fix feature remains enabled.
-

NETWORK COMMUNICATION SUBSYSTEM

In most resource-sharing environments, the network communication subsystem (NIC and physical network) is key to network performance. NetWare includes SET parameters for the network communication subsystem that allow you to adjust the amount of server system memory that NetWare can dedicate to network communication. By allocating enough server system memory (communication buffers) to the network communication subsystem, you can reduce the risk of NIC bottlenecks in the server. The following sections discuss three NetWare SET parameters that are specific to the network communication subsystem:

- SET MAXIMUM PHYSICAL RECEIVE PACKET SIZE
- SET MINIMUM PACKET RECEIVE BUFFERS
- SET MAXIMUM PACKET RECEIVE BUFFERS

SET MAXIMUM PHYSICAL RECEIVE PACKET SIZE

When installing any NIC, ensure that it is configured according to the manufacturer's specification, and configure the SET MAXIMUM PHYSICAL RECEIVE PACKET SIZE parameter to the largest supported packet size as stated by the NIC manufacturer. This allows NetWare to transmit and receive larger packets on the network, which can substantially improve network performance.



CAUTION: Ensure that both the workstation and the server are configured to use the same packet size. If you configure the workstation device driver with a larger packet size than the size defined for the server in the SET parameter, you may lose data during file-copy operations.

Use the following values as a guideline for the SET MAXIMUM PHYSICAL RECEIVE PACKET SIZE parameter.

Table 6-3
Recommended Packet Sizes

Type of NIC	Packet Size
Token Ring (16-Mbps)	4202
Token Ring (4-Mbps)	4202 (client hardware permitting)
Ethernet	1130

NOTE: Many NICs and device drivers, such as the COMPAQ 32-Bit NetFlex Controller, support larger packet sizes. When configuring network servers and workstations, ensure that you are using the largest supported packet size.

SET MINIMUM PACKET RECEIVE BUFFERS

The SET MINIMUM PACKET RECEIVE BUFFERS parameter allows you to adjust the minimum number of communication buffers that the server can allocate at startup, rather than waiting for the server to reallocate communication buffers automatically. NetWare dynamically increases this value if you set it too low, but you can expect delays when processing packets until NetWare increases this value to allow for enough buffers. An indication that this number is too low is if "No ECB Available Count" errors are generated. To view these errors, use *MONITOR.NLM*.

The minimum supported value for this parameter is 10, the maximum supported value is 1000, and the default value is 10. However, several factors can influence the use of these buffers, such as the type of NICs used and the number of users on the network. If EISA bus-master NICs are used, increase the value of the SET MINIMUM PACKET RECEIVE BUFFERS parameter to allow an additional 10 buffers for each EISA bus-master NIC. Ensure that one packet receive buffer is allocated for each network user.

For example, if you configure a COMPAQ ProSignia with 2 NetFlex Controllers and 40 users, set the parameter value to 60. This allows for 10 buffers per NetFlex Controller and an additional 40 buffers to match the number of users.

The following table provides values for the minimum packet receive buffers for this example.

Table 6-4
Minimum Packet Receive Buffers

EISA NICs		ISA NICs	
EISA NIC	10	ISA NIC	5
EISA NIC	10	ISA NIC	5
40 Users	+ 40	40 Users	+ 40
Total	60	Total	50

Since the SET MINIMUM PACKET RECEIVE BUFFERS parameter value is dynamic, monitor this value to ensure that the value of the SET **MAXIMUM** PACKET RECEIVE BUFFERS parameter is always greater than the value of the SET **MINIMUM** PACKET RECEIVE BUFFERS parameter. If the SET MINIMUM PACKET RECEIVE BUFFERS value increases to the point where it is equal to the SET MAXIMUM PACKET RECEIVE BUFFERS VALUE and server activity remains high, server performance may degrade.

Once you have configured your server, monitor it for several days to establish baseline server performance and values, and then record the value of the Packet Receive Buffers statistic in *MONITOR.NLM* or in the Server Manager/R. Change the SET MINIMUM PACKET RECEIVE BUFFERS parameter in the *STARTUP.NCF* file to your recorded value, bring down the server, and then restart the server to implement the changes. Whenever you must restart the server, the minimum packet receive buffers are allocated automatically, so the server does not spend time going through the dynamic allocation process.

-
- ! **IMPORTANT:** If you increase the value of the SET MINIMUM PACKET RECEIVE BUFFERS parameter, always ensure that the value of the SET MAXIMUM PACKET RECEIVE BUFFERS parameter exceeds the value of the SET MINIMUM PACKET RECEIVE BUFFERS parameter by at least 100.
-

NOTE: You can set the SET MINIMUM PACKET RECEIVE BUFFERS parameter only in the *STARTUP.NCF* file.

SET MAXIMUM PACKET RECEIVE BUFFERS

The SET MAXIMUM PACKET RECEIVE BUFFERS parameter establishes the maximum number of communication buffers that the server can allocate. The minimum supported value is 50, the maximum supported value is 2000, and the NetWare default value is 100.

Always ensure that the value of the SET MAXIMUM RECEIVE BUFFERS parameter is greater than the value of the SET MINIMUM PACKET RECEIVE BUFFERS parameter. Since the SET MINIMUM PACKET RECEIVE BUFFERS parameter value is dynamic, monitor these values periodically.

For most configurations, set this parameter according to the following:

$$\begin{array}{r} \text{MINIMUM PACKET RECEIVE BUFFERS Value} \\ + \quad 100 \\ \hline \text{MAXIMUM PACKET RECEIVE BUFFERS Value} \end{array}$$

-
- ! **IMPORTANT:** Increasing the SET MAXIMUM PACKET RECEIVE BUFFERS parameter takes buffers from the Cache Buffers Pool. If you increase this value, check the Resource Utilization option in *MONITOR.NLM* to ensure that there are enough buffers for other processes.
-

Chapter 7

SERVER MANAGEMENT

COMPAQ INSIGHT Server Management is a framework that includes integrated server management features and optional server management tools to provide complete server management for the network administrator. These integrated management features and optional server management tools can be used individually or together to provide comprehensive server management and server reliability.

The COMPAQ ProSignia integrated server management features are enabled using EISA Configuration Utility v2.10 or later. The optional server management tools (COMPAQ INSIGHT Manager and COMPAQ Server Manager/R) provide additional management services.

This chapter provides information on the configuration and use of the integrated server management features and optional server management tools for the COMPAQ ProSignia. Figure 7-1 illustrates the COMPAQ INSIGHT Server Management framework.

Figure 7-1
INSIGHT Server Management Framework

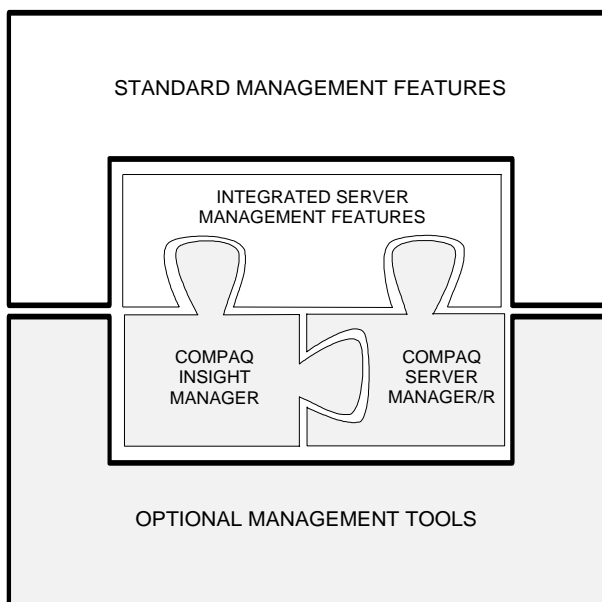

INTEGRATED SERVER MANAGEMENT FEATURES

The COMPAQ ProSignia includes integrated server management features that can be used independently of other server management products or can be used with the optional COMPAQ server management tools. Integrated server management features include the following:

- Automatic Server Recovery (ASR)
- Server Health Logs

If a critical error or failure occurs in the COMPAQ ProSignia, the ASR feature can speed server recovery by rebooting the server and notifying you that a failure has occurred. The COMPAQ ProSignia ASR feature is composed of the following:

- ASR timer, which counts down the time for a predefined period and initiates the reboot process when the timer reaches 0.
- *CPQHLTH.NLM*, which provides information in the Server Health Logs and periodically resets the ASR timer before the timer reaches 0.
- System ROM, which boots the server into the operating system or into COMPAQ Utilities when the ASR timer initiates the reboot process and notifies a designated administrator of the server failure via modem.

Server Health Logs store error and configuration information in nonvolatile memory for subsequent retrieval and analysis. You can view the Server Health Log contents using the COMPAQ INSPECT Utility (version 8.11 or later) or COMPAQ INSIGHT Manager (version 1.1 or later). By analyzing the data from the Server Health Logs, you can increase your efficiency in resolving current server problems, as well as prevent future server errors. The COMPAQ DIAGNOSTICS software also uses the data from the Server Health Logs to streamline its testing and quickly pinpoint problems.

The Server Health Logs include the Critical Error Log and the Revision History Table.

The **Critical Error Log** records catastrophic errors, such as non-correctable memory, expansion board, and expansion bus arbitration errors. After a critical error occurs, the system ROM indicates on bootup that an error has occurred and prompts you to run COMPAQ Utilities. The Critical Error Log contains the time, date, and frequency of errors logged. When a critical error is logged, the server can notify you when it reboots.

The **Revision History Table** stores board revision information in nonvolatile memory. It logs the system board revision first and then logs other boards that support the Revision History Table, such as the Fast-SCSI-2 Controller, IDA-2 Controller, and NetFlex Controller. When you upgrade your server or when you add new expansion boards, the Revision History Table logs this information. As you troubleshoot server problems, you can use this information to determine if a change to the server configuration has caused the server problem.

When a critical error occurs, the server displays a message instructing you to run DIAGNOSTICS software upon bootup. DIAGNOSTICS software shows the suspected cause of the error and offers possible resolutions. It also updates the Critical Error Log by acknowledging corrective actions.

CPQHLTH.NLM is actually independent of the ASR timer. You can load *CPQHLTH.NLM* without enabling the ASR timer. This allows *CPQHLTH.NLM* to log information in the Server Health Logs without rebooting the server in the event of a critical error. However, you cannot enable the ASR timer without loading *CPQHLTH.NLM*. The following table lists the benefits of enabling the ASR timer, of loading *CPQHLTH.NLM*, and of enabling and loading *CPQHLTH.NLM* and ASR.

Table 7-1
Benefits of Enabling ASR and Loading *CPQHLTH.NLM*

		CPQHLTH.NLM	
		Loaded	Not Loaded
A S R	Enabled	<ul style="list-style-type: none"> ■ Reboot and pager capabilities ■ Critical Error Log ■ Revision History Table 	Logs and ASR are disabled.
	Disabled	<ul style="list-style-type: none"> ■ Critical Error Log ■ Revision History Table 	Logs and ASR are disabled.

CONFIGURING *CPQHLTH.NLM*

NOTE: *CPQHLTH.NLM* is in the \HEALTH\NW31X subdirectory of the NetWare Programs from Compaq diskette v2.0.

When you enable ASR and load *CPQHLTH.NLM*, *CPQHLTH.NLM* interfaces with ASR timer hardware integrated on the system board. During normal server operation, *CPQHLTH.NLM* periodically resets the ASR timer.

If *CPQHLTH.NLM* cannot reset the ASR timer and the ASR timer reaches 0, then the server reboots, and *CPQHLTH.NLM* records the server failure information in the Critical Error Log. You can retrieve and analyze this failure information later to assist you in diagnosing the system malfunction.

! **IMPORTANT:** You can install the *CPQHLTH.NLM* in either the DOS partition of your server or in the NetWare partition. All NLMs installed in the NetWare partition are archived when you back up your server; the DOS partition is not archived. Furthermore, if you install NLMs in the NetWare partition, you can update them without having to bring down the server. Install all NLMs in the NetWare partition of your server.

To install the *CPQHLTH.NLM* in the NetWare partition of your server, perform the following procedure from a client workstation logged into the network:

1. Insert the NetWare Programs from Compaq diskette v2.0 into the workstation diskette drive.
2. From the workstation, log into the server as SUPERVISOR.
3. Execute the following MAP command to ensure that you have a path to the server:

```
MAP F:=SYS:SYSTEM
```

4. Copy the *CPQHLTH.NLM* as follows to the server:

```
COPY A:\HEALTH\NW31X\*. * F:
```

5. From the server console, load *CPQHLTH.NLM* from the NetWare prompt as follows:
LOAD CPQHLTH
6. Load NetWare *INSTALL.NLM* and add the LOAD command to the *AUTOEXEC.NCF* file as follows, so that *CPQHLTH.NLM* will load each time the server restarts:
LOAD CPQHLTH

-
- ! **IMPORTANT:** You can also load *CPQHLTH.NLM* without enabling ASR. This allows *CPQHLTH.NLM* to provide Critical Error Log and Revision History Table information without configuring the server to reboot automatically.
-

CONFIGURING AUTOMATIC SERVER RECOVERY

The Automatic Server Recovery (ASR) feature restarts the server automatically and can page a designated administrator in the event of a critical system failure. You enable and configure ASR using COMPAQ EISA Configuration Utility v2.10 or later.

CPQHLTH.NLM periodically notifies the system ROM that NetWare is operating normally and resets the ASR timer. If a critical error occurs, *CPQHLTH.NLM* records the error in the Critical Error Log, and the ASR feature reboots the server. You can also configure the server to contact the designated administrator via pager or PC communication (Figure 7-2).

-
- ! **IMPORTANT:** If you enable ASR in the EISA Configuration Utility and you do not load *CPQHLTH.NLM*, the server does not automatically reboot in the event of a critical error, nor does it provide Critical Error Log or Revision History Table information.
-

Figure 7-2
Automatic Server Recovery Flowchart

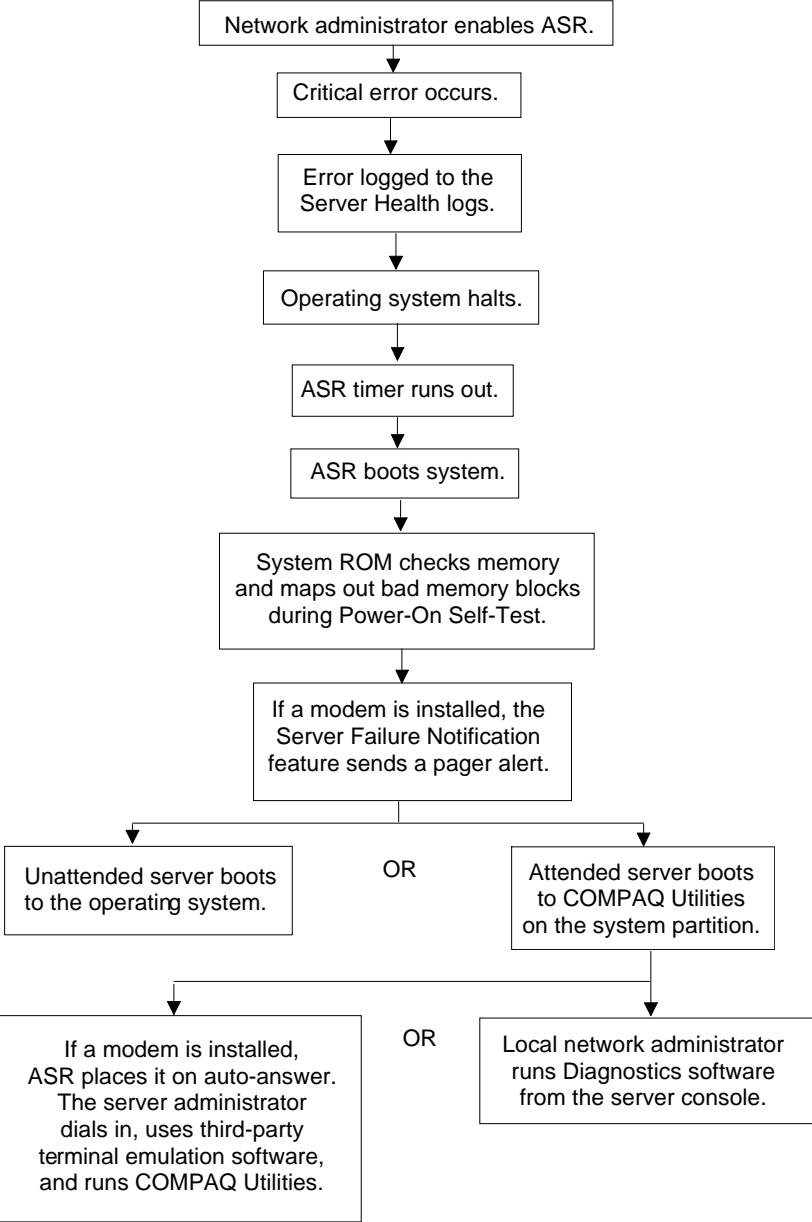

Configuring ASR on the COMPAQ ProSignia server requires the following:

- EISA Configuration Utility (v2.10 or later) to enable ASR timer
- COMPAQ DIAGNOSTICS software
- COMPAQ INSPECT Utility (v8.11 or later)
- *CPQHLTH.NLM*
- Hayes-compatible modem (optional) with dial-out features for pager notification and dial-in/dial-out features for remote access.

NOTE: Uninterruptible Power Supply (UPS) is optional for power backup.

To configure ASR, execute the COMPAQ EISA Configuration Utility, select *View and Edit Details*, and perform the following:

1. Set the ASR timer.

When you set the time for the ASR timer, the ASR feature reboots the server when the designated amount of time (for example, 10 minutes) has elapsed and there has been no notification from *CPQHLTH.NLM* that NetWare is operating normally.

The default value is 10 minutes. The options are 5 minutes, 10 minutes, 20 minutes, and 30 minutes. Use the default value for most configurations.

For remote and off-site (unattended) servers, setting the ASR timer for 5 minutes reduces the server downtime and allows the server to recover quickly. For local (attended) servers that may be located elsewhere on site, setting the ASR timer for 20 or 30 minutes allows you to arrive at the server and diagnose the problem.

2. Enter the pager number.
3. Specify the Reset Boot Option. You can choose to boot into the COMPAQ Utilities or into the operating system. The following sections discuss the circumstances under which you can boot into the COMPAQ Utilities or into NetWare.

Booting into the COMPAQ Utilities

When you enable ASR to boot into the COMPAQ Utilities and a critical error occurs, *CPQHLTH.NLM* logs the error information in the Critical Error Log, and the ASR feature restarts the server. When the system reinitializes, the system ROM tests the memory and deallocates faulty memory blocks, pages the designated administrator, boots the COMPAQ Utilities from the hard drive, and places the modem into auto-answer mode.

NOTE: The COMPAQ Utilities are loaded from a specially created Systems partition on the hard drive that was configured during server configuration. Refer to Table 2-2, "Preinstallation Checklist." The COMPAQ TechNote for NetWare *COMPAQ IDA-2 Configuration for NetWare* provides more detailed information.

You can access the server and view the Server Health Logs either remotely or from the NetWare server console. For remote access, you must have a communication software package that is capable of terminal emulation to a local terminal with VT100 or ANSI terminal support. If your remote site does not include this configuration, you can still access the server remotely if you have a software package that includes an ANSI terminal or a VT100 terminal emulator set for 8 data bits, 1 stop bit, and no parity.

You can also enable ASR to dial out to a configured remote PC workstation. When a critical error occurs, ASR not only pages you, but also connects to the remote PC workstation.

Your EISA Configuration Utility setting should resemble the following when you enable ASR to boot into the COMPAQ Utilities:

Serial Interface	COM1
Pager Status	Enabled
Pager Dial String	ATDT555-5555
Message	1234567
Dial In Status	Enabled
Dial Out Status	Enabled
Dial Out String	555-1234



The *Pager Status* option enables and disables the modem. The *Message* option represents a unique number (maximum seven digits, *numeric only*) that you must designate to identify the server on your pager display. The *Dial In Status* option allows you to dial in from a remote PC workstation. This is also referred to as "auto-answer mode." The *Dial In Status* option must be enabled to access DIAGNOSTICS software from a remote PC. The *Dial Out Status* option allows ASR to dial out to a remote PC workstation.

If you configure the server to reboot into the COMPAQ Utilities, the server prepares for remote communications, so you can remotely run DIAGNOSTICS software, INSPECT Utility, or EISA Configuration Utility using a PC running terminal emulation software.

When you finish with the COMPAQ Utilities, the server reboots into the *AUTOEXEC.BAT* file and resumes operation. Include command lines similar to the following lines at the end of the server *AUTOEXEC.BAT* file to restart NetWare when the server reboots.

```
CD C:\NW311
SERVER
```

Booting into NetWare

When you enable ASR to boot into the operating system and a critical error occurs, *CPQHLTH.NLM* logs the error information in the Critical Error Log, and the ASR feature restarts the server. The system ROM tests the server memory and deallocates faulty memory blocks, pages the designated administrator, and executes an *AUTOEXEC.BAT* file that includes the NetWare *SERVER.EXE* file.

-
- ! **IMPORTANT:** When you enable ASR to boot into the operating system, Dial In Status and Dial Out Status are automatically disabled. In this mode, ASR can page you in the event of a critical error, but you cannot access the server, and the server cannot dial out to a remote PC workstation.
-

During the recovery process, the ASR feature will attempt to reboot the server up to 10 times. If the ASR feature cannot reboot the server within the 10 retries, *CPQHLTH.NLM* logs a critical error in the Critical Error Log, boots the server into the COMPAQ Utilities, and places the modem in auto-answer mode. If the server cannot boot into the COMPAQ Utilities, then the firmware generates the standard boot failure routine.

Your EISA Configuration Utility setting should resemble the following when you enable ASR to boot into NetWare:

Serial Interface	COM1
Pager Status	Enabled
Pager Dial String	ATDT555-5555
Message	1234567
Dial In Status	Disabled
Dial Out Status	Disabled
Dial Out String	

The *Pager Status* option enables and disables the modem. The *Message* option represents a unique number (maximum seven digits, *numeric only*) that you must designate to identify the server on your pager display. The *Dial In Status* option is automatically disabled when you configure ASR to boot into NetWare. When ASR pages you, you cannot dial in unless ASR exceeds the threshold number of server restart retries (10). When this happens, ASR boots the server into the COMPAQ Utilities and places the modem in auto-answer mode. The *Dial Out Status* option is also disabled when you configure ASR to boot into NetWare.

If you configure the system to reboot into NetWare, all commands in the *AUTOEXEC.BAT* file are executed; therefore, include the following lines at the end of the server *AUTOEXEC.BAT* file to restart NetWare when the server reboots.

```
CD C:\NW311
SERVER
```

USING COMPAQ SERVER HEALTH LOGS

You can use the Server Health Logs to track changes to your server configuration and to troubleshoot server problems in the event of a critical error. The following sections discuss how to acknowledge and view the information in these logs and how to interpret the data that they provide.

Using the Critical Error Log

The Critical Error Log contains non-correctable memory errors and catastrophic hardware and software errors that can cause server failure. When you load *CPQHLTH.NLM*, you can view the Critical Error Log from the INSPECT Utility or from INSIGHT Manager by clicking on the HEALTH button. When you do not load *CPQHLTH.NLM*, the Critical Error Log receives no data, and INSIGHT Manager does not show the HEALTH button. Table 7-2 lists Critical Error Log messages.

Table 7-2
Critical Error Log Messages

Error Message	Description
Automatic Server Recovery Base Memory Parity Error	Data error in base memory following server reboot due to ASR timer expiration.
Automatic Server Recovery Extended Memory Parity Error	Data error in extended memory following server reboot due to ASR timer expiration.
Automatic Server Recovery Memory Parity Error	Inability of system ROM to allocate memory to create a stack. ROM fails to display a message or reboot the server.
Automatic Server Recovery Reset Limit Reached	Server reaches threshold number of restart retries (10). Server boots into COMPAQ Utilities or executes standard boot failure routine.
Error Detected on Boot Up	Error detected during POST.
NMI- Expansion Board Error	Error condition on expansion board.
NMI - Expansion Bus Master Time-out	Bus-master expansion board fails to release the bus after maximum time.
NMI - Expansion Bus Slave Time-out	Expansion board delays the bus cycle and causes a time-out.
NMI - Fail-safe Timer Expiration	NetWare fails to reset the fail-safe timer.
Processor Exception	Processor exception occurs.
NMI - Processor Parity Error	Processor detects a data error.
Server Manager Failure	Server interface error in Server Manager/R.
NMI - Software Generated Interrupt Detected Error	Software-generated system error in the operating system or an application.

Acknowledging Critical Error Log Entries

When you reboot the server, the Power-On Self-Test (POST) displays a message at server startup indicating the existence of an error condition and suggesting that you run DIAGNOSTICS software. When you run DIAGNOSTICS software, it updates the log by marking the error as having received corrective action. DIAGNOSTICS software then displays the suspected cause of the error and provides possible resolutions to the problem.

If DIAGNOSTICS software recognizes a similarity between a new entry and an entry that is marked for corrective action taken, it concludes that the action taken did not resolve the problem. DIAGNOSTICS software then refers you to additional documentation, but does not attempt to re-diagnose the problem. Use the documentation to isolate the cause of the failure.

If the Critical Error Log includes multiple errors that are logged *more than one hour apart*, DIAGNOSTICS software treats each error separately. It treats critical errors that occur within the same hour as a group of related errors, addresses only the *most severe* error, and marks all other errors in the group as "Corrective Action Taken (CAT)."

The following errors are listed in priority order beginning with the most severe:

1. Non-correctable memory error
2. Cache parity error
3. Processor parity error
4. IOCHK
5. Bus master time-out
6. Command time-out
7. Refresh queue overflow

Using the Revision History Table

Some errors can be caused by changes made to the server configuration. The COMPAQ ProSignia includes the Automatic Revision Tracking (ART) feature that allows you to review the changes that have been made to the COMPAQ ProSignia configuration.

The Revision History Table includes the hardware revision number of the system board and any other EISA expansion boards that can provide ART-compatible version information. The Revision History Table, like the Critical Error Log, is stored in non-volatile memory and can be viewed via the INSPECT Utility or INSIGHT Manager.

The Revision History Table enters the revision of the system board first, and then logs all entries beyond the system board in random order. All hardware that supports the Revision History Table must include an available board revision byte at a port that is specified in the board configuration files. This board revision byte provides ART compatibility.

You can view the following information from the Revision History Table:

- Type of board (system or EISA)
- Slot number
- EISA ID
- Version

When you change your server hardware configuration by adding expansion boards, changing other hardware, or upgrading ROM revisions, the EISA Configuration Utility updates the Revision History Table, but retains the previous configuration information in the EISA Configuration History Files. This set of EISA Configuration History Files is also an ART feature that allows you to review modifications to the server configuration. The EISA Configuration History Files retain a history of the system configuration, based on the *three most recent* configurations from the EISA Configuration Utility. This allows you to correlate hardware changes with server failures.

You can view and print any of the last three server configurations in the EISA Configuration History Files using the INSPECT Utility. You can also reinstall any of these three configurations using the Maintain Configuration Utility option in EISA Configuration Utility.

COMPAQ INSIGHT MANAGER









COMPAQ INSIGHT Manager, a proactive server management tool, complements and enhances the integrated server management features (ASR and Server Health Logs) of the COMPAQ ProSignia by providing the following features:

- Online access to ASR configuration and Critical Error Log information.
- Access to server status and hardware configuration with real-time monitoring or historical report generation.
- Alerting for Fast-SCSI-2, IDA, and IDA-2 subsystems, ASR, and Critical Error Log status.

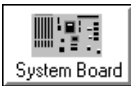
COMPAQ INSIGHT Manager is a Microsoft Windows-based application that operates on the network using the Simple Network Management Protocol (SNMP) over IPX. This allows you to monitor and receive alerts from multiple NetWare servers at a single location. It runs on a workstation (called a *management PC*) that is attached to the network and provides server-specific data. The Automatic Data Collection feature and a built-in report generator provide historical information, so you can track performance trends and troubleshoot server problems. You can print periodic reports to spot trends or to isolate a suspected problem. You can also use the information from Automatic Data Collection to monitor performance for component degradation and wear and to schedule preventive maintenance.

INSIGHT Manager works with the COMPAQ ProSignia integrated server management features by showing hard drive and Server Manager/R subsystem information, the status of ASR, and the contents of the Critical Error Log on line (and on the network). You can access the information in the Critical Error Log by clicking the HEALTH button. Using INSIGHT Manager with the integrated server management features allows you to access desired information over the network while NetWare is still running. For example, without INSIGHT Manager, accessing information on the server hardware configuration, ASR status, and Critical Error Log would require taking the server off line and running the INSPECT Utility. The following table lists and describes the information and alerting functions that INSIGHT Manager provides.

Table 7-3
INSIGHT Manager Options

Category	Type	Monitored Items
 Configuration	Information	Bus and processor type, serial and parallel port addresses, pointing device status, video, keyboard type, ROM version/type/family, security status, base and total memory, system resources used. Similar to online INSPECT Utility.
 Security Config	Information	Network Server Mode, Power-on Password, Prevent Diskette Boot, QuickLock, port and drive control, and QuickBlank.
 Disk Storage	Alerting & Information	Fast-SCSI-2 and IDA-2 function tests, error statistics, hours of operation, firmware and driver versions, and drive description. Alerting indicates drive subsystem errors and degraded performance conditions that allow you to take measures prior to drive failure.
 System Board	Alerting & Information	ASR status, pager and modem settings, Critical Error Log, system ROM version, ROM family and type, processor type, bus type, I/O check, base and total memory, memory parity.
 Auto Recovery	INCLUDES INTEGRATED SERVER MANAGEMENT FEATURES	Alerting indicates critical errors. You can view integrated server management features while the server is on line. Use INSPECT Utility when server is off line.
 Critical Errors		
 Expansion Bds	Information	Installed options, board name and ID, slots, and resources used.
 Server Mgr /R	Alerting & Information	Board name and ID, board status, ROM version, alert destination list, and modem settings. Provides on-the-network Server Manager/R alerting, indicating the condition of the Server Manager board, battery, and driver status.
 I/O Ports	Information	Parallel port status and address, serial port statistics and address, pointing device status, keyboard type, and video.
 Environment	Information	Current voltage and temperature, as well as voltage and temperature change.

A proactive management tool such as INSIGHT Manager alerts you of conditions that may indicate a potential hard drive failure, a problem with the Server Manager board, or the need for server maintenance. In a multiserver environment, configuration management, reporting, and trend analysis become even more important when tracking problems and allocating administrative resources.

INSIGHT Manager can monitor the condition of Fast-SCSI-2 and IDA-2 subsystems and alert you of hard drive degradation before an actual failure occurs. When monitoring hard drive problems, DIAGNOSTICS software plays a key role in determining when a drive should be considered for replacement. If you receive the Physical Drive Threshold Exceeded alert, the hard drive is still operational, but has degraded beyond one or more of the factory-preset thresholds. The thresholds are set to provide warning of degraded performance before failures occur. In some cases, you can continue to monitor the drive for further problems and schedule maintenance.

-
- ! **IMPORTANT:** When using INSIGHT Manager to monitor system component wear, DIAGNOSTICS software must report a failure before you can consider the drives or other assemblies for replacement. For more information and assistance with drive replacement, contact your Authorized COMPAQ Computer Reseller or Service Provider or call the Compaq Customer Support Center at 1-800-345-1518 in North America. In Canada, call 1-800-263-5868. Outside the United States and Canada, contact the local Compaq Computer Corporation office from which you normally receive support.
-

Using INSIGHT Manager with the integrated server management features allows you to move from a reactive mode of management to a proactive mode of management. Server uptime is increased, because you are aware of problems as they develop, rather than after they have caused a system failure. This allows you to schedule maintenance during off-peak hours. Furthermore, when the server is unattended, ASR and the Critical Error Log enable the server to recover automatically, notify you of the failure, and save the record of occurrences that led to the failure.

NOTE: For more information, refer to the COMPAQ TechNotes *NetWare Server Management* and *COMPAQ IDA-2 Configuration for NetWare*.

COMPAQ SERVER MANAGER/R

COMPAQ Server Manager/R is a hardware and software solution that includes the COMPAQ 32-Bit Server Manager/R board, Server Manager Support software, and COMPAQ Server Manager Facility/R. It provides the following:

- Remote Console emulation.
- NetWare information on CPU utilization, current and peak connections, locked-out users, and space available on volumes.
- NIC statistics.
- IDA and IDA-2 subsystem information.
- Server hardware and environment information.

-
- ! **IMPORTANT:** When configuring the COMPAQ ProSignia and Server Manager/R, ensure that the revision of the Server Manager/R board is *revision N or greater*. The revision is marked on the board above the battery. If you configure the Server Manager/R board with the COMPAQ ProSignia and EISA Configuration Utility Version 2.10 displays a message stating that the board is not supported, obtain revision N or later.

Contact your Authorized COMPAQ Reseller or Authorized COMPAQ Service Provider, or call the Compaq Customer Support Center at 1-800-345-1518 in North America. In Canada, call 1-800-263-5868. Outside the United States and Canada, contact the local Compaq Computer Corporation office from which you normally receive support.

Server Manager/R monitors the server hardware, its environment, and selected items in the operating system software. Server Manager/R provides configuration management, alerting, and remote server management via an asynchronous connection (off the network), so you can monitor server subsystems and receive alerts.

Server Manager/R also allows you to control the server using the Remote Console feature and to make changes to the server from a remote location. These changes include modifying NetWare SET parameters, loading and unloading NLMs, bringing down the server, and rebooting the server to identify POST errors.

Server Manager/R supplements the COMPAQ ProSignia integrated server management features by providing additional alerting capabilities and remote console functions, as well as enhanced flexibility in alerting. Server Manager/R allows you to build alert destination lists with multiple destination phone numbers for pager and voice alerting. It also provides scheduling, so you can control when alerts should be sent.

Server Manager/R can monitor the condition of the IDA-2 subsystem and alert you to degraded conditions before you experience a drive failure. It monitors IDA-2 parameters, displays IDA-2 status, and sends alerts when significant changes in these parameters occur.



CAUTION: If you install a Server Manager/R board and an IDA-2 Controller, use the Drive Array Instrumentation NLM, *CPQDAIA.NLM* version 1.11 or later from the Server Manager Support Software diskette. Versions prior to 1.11 may cause your server to abnormally end (ABEND) in the distributed data guarding fault tolerance mode (RAID 5).

DIAGNOSTICS software must report a failure before you can consider drives or other assemblies for replacement. If you receive the Physical Drive Threshold Exceeded alert in INSIGHT Manager, the drive is still operational, but has degraded beyond one or more of the factory-preset thresholds. These thresholds are set to provide warnings of degraded performance before actual failures occur. In some cases, you can monitor the drive for additional problems and schedule system maintenance.



IMPORTANT: For more information, contact your Authorized COMPAQ Computer Reseller or Service Provider or call the Compaq Customer Support Center at 1-800-345-1518 in North America. In Canada, call 1-800-263-5868. Outside the United States and Canada, contact the local Compaq Computer Corporation office from which you normally receive support.

QUESTIONS AND ANSWERS

The following represent common questions concerning server management and the COMPAQ ProSignia.

Q: What are the integrated server management features in the COMPAQ ProSignia?

A: The integrated server management features are built into the COMPAQ ProSignia. These features require no optional hardware or software to configure. They include:

- Automatic Server Recovery (ASR)
- Critical Error Log
- Revision History Table

Q: What is ASR and what does ASR do?

A: Automatic Server Recovery (ASR) is a COMPAQ ProSignia integrated feature that provides automatic reboot capabilities in the event of a server failure. The ASR feature includes the following:

- ASR timer, which counts down from a predefined period and initiates the reboot process when it reaches 0.
- *CPQHLTH.NLM*, which provides information in the Server Health Logs and periodically resets the ASR timer before the timer reaches 0.
- System ROM, which boots the server into the operating system or into COMPAQ Utilities and notifies a designated administrator of the server failure via modem.

When the server experiences a critical error, the ASR feature can log the critical error, alert you via pager, and either reboot into the operating system or reboot into COMPAQ Utilities. Booting into COMPAQ Utilities allows you to run EISA Configuration Utility, DIAGNOSTICS software, or INSPECT Utility remotely before restarting the operating system.

Q: Are INSIGHT Server Management and INSIGHT Manager synonymous?

A: INSIGHT Server Management is a *framework* that defines hardware, software, and management tool elements to make COMPAQ servers easier to manage and use in a network environment. Hardware and software elements include the integrated server management features in the COMPAQ ProSignia. INSIGHT Server Management tools include COMPAQ INSIGHT Manager and COMPAQ Server Manager/R.

COMPAQ INSIGHT Manager is a Windows *application* that provides information for managing your server. INSIGHT Manager is also based on the INSIGHT Server Management framework to make COMPAQ servers easier to manage and use.

Q: Can I configure a COMPAQ ProSignia to notify me if it crashes? If so, do I need special hardware or software to configure the COMPAQ ProSignia to notify me?

A: To configure a COMPAQ ProSignia server to notify you via pager, configure a Hayes-compatible modem for your server, enable ASR using the EISA Configuration Utility, and load the *CPQHLTH.NLM* for NetWare. When enabling ASR, enable the pager and supply the appropriate pager telephone number as well as a server identification number (shown as *Message* in the EISA Configuration Utility). The identification number identifies which server has experienced a critical error.

Q: My internal network includes 10 COMPAQ ProSignia servers. How can I track the configuration of each server and monitor each server for potential problems, so that I can schedule preventive maintenance before a critical error occurs?

A: The integrated server management features in the COMPAQ ProSignia can provide information on configuration *changes* and can notify you in the event of a critical error; however, these features cannot provide complete configuration information, nor can they indicate the potential for subsystem problems.

INSIGHT Manager can provide complete configuration information on your servers by generating status reports. INSIGHT Manager can also alert you when server component degradation occurs, indicating the need for maintenance. It provides complete hardware information for both Fast-SCSI-2 and IDA-2 subsystems. It also displays the server Critical Error Log on the network, eliminating the need to bring down the server to check configuration information or server health.

When the server is unattended (for example, after office hours), you can enable the ASR pager option to notify you of a critical error and configure the server to reboot automatically into the operating system when the critical error occurs.

Q: My network includes multiple COMPAQ ProSignia servers. Some of these servers are attached to the internal network, and some of them are attached to remote independent networks. How can I track all of these servers and be aware of any problems that may occur?

A: Use a combination of INSIGHT Manager and Server Manager/R for environments that include both internal and remote servers. Configure the internal servers with INSIGHT Manager, which allows you to monitor these servers on the network. Configure the remote servers with Server Manager/R, so you can monitor these remote servers off the network and manage them in the event of a server problem.

Q: What happens if I enable the ASR feature in the EISA Configuration Utility and I do not load *CPQHLTH.NLM*?

A: You must load *CPQHLTH.NLM* in order for the ASR reboot capability to work. If you enable ASR and do not load *CPQHLTH.NLM*, you receive no notification of a server failure and no information in the Server Health Logs.

Q: What happens if I do *not* enable the ASR feature in the EISA Configuration Utility, but load *CPQHLTH.NLM*?

A: If you load *CPQHLTH.NLM* without enabling the ASR feature, you receive no notification (via pager or remote PC) of a server failure; however, *CPQHLTH.NLM* logs all information in the Server Health Logs.

Q: Can I dial into the server if I have configured the ASR feature to boot into NetWare?

A: The Dial In Status is automatically disabled when you configure your server to boot into the operating system. You cannot access the server remotely unless the server reboots into the COMPAQ Utilities.

Q: What happens if the server cannot boot into NetWare?

A: The server makes 10 attempts to boot into the operating system. When it cannot boot into the operating system within 10 attempts, it automatically boots into the COMPAQ Utilities if the COMPAQ Utilities have been installed in the Systems partition of the hard drive. If the server cannot boot into the COMPAQ Utilities, it generates a standard boot failure routine.

INDEX

A

Acknowledging Critical Error Log entries	7-12
Alerting	
using ASR	7-14, 7-20, 7-21
using INSIGHT Manager	7-14, 7-15, 7-21
using Server Manager/R	7-18
Alignment Errors, Ethernet custom statistics	4-5
ARI/FCI Errors, Token Ring custom statistics	4-7
Array Accelerator	1-5, 3-12
Array Striping Factor, EISA Configuration Utility	3-12
ASPI host number, described	5-1
ASPI support	
Cheyenne ARCserve	1-4, 1-7
configuration	5-1
Fast-SCSI-2	1-4, 1-7, 3-2, 5-1
multiple SCSI devices	5-2
ASR	
alerting	7-14, 7-20, 7-21
auto-answer mode, described	7-9
benefits illustrated	7-3
configuration requirements	7-7
<i>CPQHLTH.NLM</i> and	7-2, 7-7, 7-8, 7-10, 7-19, 7-21, 7-22
described	7-2, 7-19

ASR *Continued*

Dial In Status option	7-9, 7-10, 7-22
Dial Out Status option	7-9, 7-10
disabled	7-3
EISA Configuration Utility	7-7, 7-8
enabled	7-3
enabling without loading <i>CPQHLTH.NLM</i>	7-5, 7-21
Hayes-compatible modem	7-7, 7-8
illustrated	7-6
INSIGHT Manager and	7-14, 7-15
INSPECT Utility	7-19
loading <i>CPQHLTH.NLM</i> without enabling ASR	7-22
memory parity errors	7-11
Message option, described	7-9, 7-10, 7-20
modem settings	7-15
pager	7-7, 7-15
Pager Status option	7-9, 7-10
processor exception	7-11
rebooting the server	7-10, 7-19, 7-21
Reset Boot option	
booting into COMPAQ Utilities	7-8
booting into NetWare	7-9, 7-22
reset limit reached	7-11, 7-22
timer	
default value	7-7

ASR

timer <i>Continued</i>	
expiration	7-11
options	7-7
UPS and	7-7
AUI to BNC, NetFlex Controller	1-8, 4-1
<i>AUTOEXEC.BAT</i> file	7-9, 7-10
<i>AUTOEXEC.NCF</i> file	
<i>CPQHLTH.NLM</i> and	7-5
<i>CPQSASPI.NLM</i>	5-2
NIC device drivers	4-5
<i>SYNCPTCH.NLM</i>	3-17
Automatic Data Collection, INSIGHT Manager	7-14
Automatic Revision Tracking (ART)	7-12
Automatic Server Recovery	<i>See ASR</i>

B

BNC connection for NetFlex Controller	1-7, 4-1
Board revision for Server Manager/R	1-8, 7-17
Boot disk, IDA-2 and Fast-SCSI-2 configuration	3-14
Broadcast Packets Received, Token Ring custom statistics	4-6
Burst Errors, Token Ring custom statistics	4-7

C

Cables	<i>See Device cables</i>
Cache buffer size	
Fast-SCSI-2	6-4
IDA-2	6-12
multiple volumes	6-5
setting to match volume block size	6-4
volume does not mount	6-4, 6-5
Cache Buffers pool	6-1, 6-2, 6-20
Carrier Sense Errors, Ethernet custom statistics	4-6
Checklist, NetWare preinstallation	2-8
Cheyenne ARCserve	1-4, 1-7, 5-1
Collisions, Ethernet custom statistics	4-5
Communication buffers	<i>See Packet receive buffers</i>
COMPAQ 1050-Megabyte Fast-SCSI-2 Hard Drive	2-4, 6-7
COMPAQ 32-Bit NetFlex Controller	<i>See NetFlex Controller</i>
COMPAQ 330-Megabyte Fast-SCSI-2 Hard Drive	2-4, 2-7, 6-7, 6-9
COMPAQ 4-Megabyte Array Accelerator Write Cache	<i>See Array Accelerator</i>

COMPAQ 550-Megabyte Fast-SCSI-2 Hard Drive	2-4, 2-7, 6-7, 6-8
COMPAQ AUI to BNC Converter	1-7, 4-1
COMPAQ DIAGNOSTICS Utility <i>See DIAGNOSTICS software</i>	
COMPAQ drive mirroring	
described	1-6
Dynamic Sector Repairing and	6-16
IDA-2 configuration	3-12, 6-15
resynchronizing mirrored partitions	3-17
split seeks	6-15
<i>SYNCPTCH.NLM</i>	3-17
COMPAQ EISA Configuration Utility <i>See EISA Configuration Utility</i>	
COMPAQ INSIGHT Manager <i>See INSIGHT Manager</i>	
COMPAQ INSIGHT Server Management Technology <i>See INSIGHT Server Management</i>	
COMPAQ INSPECT Utility <i>See INSPECT Utility</i>	
COMPAQ Intelligent Drive Array Controller-2 <i>See IDA-2</i>	
COMPAQ ProSignia	
diskette drive location	2-4
drive bays and SCSI IDs	2-4
hardware configuration, illustrated	2-2
INSIGHT Manager and	7-20

COMPAQ ProSignia *Continued*

integrated server management features	1-8, 7-2, 7-19
multiple NICs	4-2
NetFlex Controller configuration	4-1
performance considerations	6-1
preinstallation checklist	2-8
server failure notification	7-20
Server Manager/R revision	1-8, 7-17
COMPAQ Server Manager/R <i>See Server Manager/R</i>	
COMPAQ Utilities	2-9, 7-8, 7-22
<i>CONFIG.SYS</i> file	2-9
Configuring Fast-SCSI-2	
controller duplexing	3-7
NetWare drive mirroring	3-5
with IDA-2	3-14
Control Order Field, EISA Configuration Utility	3-8
Controller duplexing	
described	1-6
Dynamic Sector Repairing and	6-16
Fast-SCSI-2	2-1
IDA-2	3-11
NetWare configuration	3-7
recommendations	3-11
split seeks	6-15

Controller duplexing *Continued*

<i>SYNCPTCH.NLM</i>	3-17
Corrective Action Taken (CAT)	7-12
<i>CPQDA386.DSK</i>	3-13, 3-15, 6-15
<i>CPQETHNW.LAN</i>	4-1, 4-3, 4-5
<i>CPQHLTH.NLM</i>	
ASR and	7-5, 7-7, 7-21
benefits illustrated	7-3
configuration	7-4
Critical Error Log and	7-4, 7-11
enabling ASR without loading <i>CPQHLTH.NLM</i>	7-5, 7-21
installing in NetWare partition	7-4
loaded	7-3
loading without enabling ASR	7-5, 7-22
not loaded	7-3
<i>CPQS710.DSK</i>	3-2, 3-15, 5-2, 6-3
<i>CPQS94.DSK</i>	3-2
<i>CPQSASPI.NLM</i>	3-2, 3-15, 5-1, 5-2
<i>CPQSDISK.DSK</i>	3-2, 3-15, 6-3, 6-11
<i>CPQSXPT.DSK</i>	3-2, 3-15, 6-3
<i>CPQTOKNW.LAN</i>	4-1, 4-3, 4-6
Creating a DOS partition	2-9
Critical Error Log	
acknowledging log entries	7-12
alerting	7-14

Critical Error Log *Continued*

Corrective Action Taken (CAT)	7-12
<i>CPQHLTH.NLM</i>	7-4, 7-11
described	7-3
entries in order of priority	7-12
INSIGHT Manager and	7-14, 7-15
messages	7-11
multiple errors	7-12

Custom statistics

<i>MONITOR.NLM</i> and	4-5, 4-6
NetFlex Controller	4-5
other Token Ring NICs and	4-8
Server Manager/R and	4-5, 7-17

D

Data guarding

described	1-6
Dynamic Sector Repairing and	6-16
IDA-2 configuration	3-12

Deferred Transmissions, Ethernet custom statistics	4-6
--	-----

Degraded hard drives	7-16, 7-18
----------------------	------------

Destination lists for Server Manager/R	7-18
--	------

Device cables

Fast-SCSI-2	2-6
IDA-2	2-7, 2-8
part numbers	2-7, 2-8
SCSI Zero Device Cable	2-7

Device drivers		Disk caching, system memory and	6-1
<i>CPQDA386.DSK</i>	3-13, 3-15, 6-15	Diskette drive, location	2-4
<i>CPQETHNW.LAN</i>	4-1, 4-3, 4-5	Distributed data guarding	
<i>CPQTOKNW.LAN</i>	4-1, 4-3, 4-6	described	1-5
Fast-SCSI-2		Dynamic Sector Repairing and	6-16
<i>CPQS710.DSK</i>	3-2, 3-15, 5-2, 6-3	IDA-2 configuration	3-12
<i>CPQSASPI.NLM</i>	3-2, 3-15, 5-1, 5-2	performance considerations	6-15
<i>CPQSDISK.DSK</i>	3-2, 3-15, 6-3, 6-11	DMA Bus Errors, Token Ring custom statistics	4-8
<i>CPQSXPT.DSK</i>	6-3	DMA Parity Errors, Token Ring custom statistics	4-8
device driver efficiency and performance	6-3	DOS memory manager	2-9
illustrated	3-3	DOS partition	2-5, 2-9
<i>SU001.NCF</i> file	3-4, 3-6, 3-8	Drive	
<i>SU002.NCF</i> file	3-15		<i>See Hard drive subsystem</i>
network frame type	4-4	Drive array	
using <i>CPQDA386.DSK</i> and <i>ISADISK.DSK</i>	3-11		<i>See IDA-2</i>
DIAGNOSTICS software		Drive bays	
acknowledging Critical Error Log entries	7-12	locations	2-2
ASR and	7-7	matching SCSI ID	2-4, 3-9
degradation of hard drive condition	7-16	Drive cables	
running from a remote workstation	7-9		<i>See Device cables</i>
Server Health Logs and	7-2	Drive mirroring	
Systems partition on the hard drive	2-9	described	1-6
Dial In Status option, ASR	7-8, 7-9, 7-22	IDA-2 configuration	3-12
Dial Out Status option, ASR	7-8, 7-9, 7-10	NetWare	
Disabling the Integrated Fast-SCSI-2 Controller	2-7	configuration	3-5
Disk		<i>SYNCPATCH.NLM</i>	3-17
	<i>See Hard drive subsystem</i>		

Drive mirroring <i>Continued</i>	
resynchronizing mirrored partitions	3-17
<i>SYNCPTCH.NLM</i>	3-16
Drive spanning, performance effects	
6-9	
Drive Threshold Exceeded alert	
INSIGHT Manager	7-16
Server Manager/R and INSIGHT Manager	7-18
Dynamic Sector Repairing	
6-14, 6-16	

E

EISA Configuration Utility	
Array Striping Factor	3-12
ASR	7-7, 7-19
Control Order Field	3-8
enabling integrated server management features	7-1
hard drive controller configuration	2-3, 2-4, 3-1
history of revisions	7-13
Maintain Configuration Utility option	7-13
NetFlex Controller configuration	4-1, 4-2
recommended version	2-1
Revision History Table and	7-13
running	2-9
running from a remote workstation	7-9
SCSI ID and	2-4
Server Manager/R and	1-8, 7-17
settings for enabling ASR	7-8, 7-10

Enabling ASR and loading <i>CPQHLTH.NLM</i>	7-3, 7-21
Environment, INSIGHT Manager	7-15
Ethernet	
configuring multiple controllers	4-2
<i>CPQETHNW.LAN</i> device driver	4-1, 4-3, 4-5
custom statistics	4-5
NetFlex Controller configuration	4-1, 4-2
recommended packet size	6-18

Excessive Collisions, Ethernet custom statistics	4-6
Expansion board error, NMI	7-11
Expansion bus master time-out, NMI	7-11
Expansion bus slave time-out, NMI	7-11

F

Fail-safe timer expiration, NMI	7-11
Fast-SCSI-2	
ASPI support	1-4, 1-7, 3-2, 5-1
boot disk and IDA-2	3-14
cache buffer size	6-4
configuration	
controller duplexing	3-7
NetWare drive mirroring	3-5
no fault tolerance	3-4
with IDA-2	3-14
configuring as boot disk	3-14

Fast-SCSI-2 *Continued*

Controller board	
controller duplexing	2-3
described	1-3
device cables	2-7
slot location	2-3, 2-4, 3-1
controller duplexing	2-1
<i>CPQSASPI.NLM</i>	3-2, 3-4, 3-8, 3-15, 5-2
critical error alerting with INSIGHT Manager	7-14
defined	1-3
degradation of hard drive condition	7-16, 7-18
device cable requirements for	2-6
device drivers	
<i>CPQS710.DSK</i>	3-2, 3-15, 5-2, 6-3
<i>CPQSASPI.NLM</i>	3-2, 3-15, 5-1
<i>CPQSDISK.DSK</i>	3-2, 3-15, 6-3
<i>CPQSXPT.DSK</i>	6-3
efficiency and performance	6-3
illustrated	3-3
location	6-3
<i>SU001.NCF</i> file	3-4
<i>SU002.NCF</i> file	3-15
disk storage, INSIGHT Manager	7-15
drive spanning performance	6-9
hard drives	2-4
hardware configuration	2-3
Hot Fix Redirection Area	6-14
Integrated	
50-pin external SCSI-2 connector and	2-4

Fast-SCSI-2

Integrated <i>Continued</i>	
controller duplexing	2-3
described	1-3
device cables	2-7
IDA-2 Controller and	2-7
originate connector	2-2
slot location	2-4
terminate connector	2-2
terminating the SCSI bus	2-7
interleaved data transfers	1-4, 6-8
maximum number of supported devices	2-4
monitoring with INSIGHT Manager	7-16
multiple drives	6-7
NetWare installation	3-1
performance tuning	6-3
read-after-write verification	6-10
scatter/gather	1-3, 6-3, 6-7
SCSI bus	2-4, 5-1, 5-2
SCSI ID	2-4, 3-9
SCSI Zero Device Cable	2-7
<i>SCSI.EXE</i> file	3-14
setting the Control Order Field	3-8
sharing interrupts with IDA-2	2-7
<i>SU001.NCF</i> file	3-4, 3-6, 3-8
<i>SU002.NCF</i> file	3-15
support for 8-bit SCSI devices	1-4
tagged command queuing	1-3, 6-3, 6-8

Fast-SCSI-2 <i>Continued</i>	
tape drive and	1-7
volume block size	2-1, 6-4
FASTART Utility	2-9
Fault tolerance	
controller duplexing	1-6, 3-11, 3-17, 6-15, 6-16
data guarding	1-6, 3-12, 6-15, 6-16
distributed data guarding	1-6, 3-12, 6-15, 6-16
drive mirroring, COMPAQ	1-6, 3-12, 6-15, 6-16
drive mirroring, NetWare	1-6, 6-16
Dynamic Sector Repairing and	6-16
Fast-SCSI-2	
controller duplexing	1-6, 3-7, 6-15, 6-16
NetWare drive mirroring	1-6, 3-5, 6-15, 6-16
IDA-2	
COMPAQ drive mirroring	1-6, 3-12, 6-15, 6-16
controller duplexing	3-11, 6-15, 6-16
data guarding	1-6, 3-12, 6-15, 6-16
distributed data guarding	1-6, 3-12, 6-15, 6-16
NetWare drive mirroring	1-6, 6-15, 6-16
performance considerations	6-14
read-after-write verification and	6-16
resynchronizing mirrored partitions	3-17
<i>SYNCPATCH.NLM</i>	3-17
FCS Errors, Ethernet custom statistics	4-5
FDISK Utility	2-9
Fixed disk drive	<i>See Hard Drive Subsystem</i>

Formula, calculating system memory	6-2
Frame Copied Errors, Token Ring custom statistics	4-7
Frame types supported by NetFlex Controller	4-4

H

Hard drive subsystem	
configuring IDA-2	3-12
configuring IDA-2 and Fast-SCSI-2	3-14
controller slot location	2-3, 2-4, 3-1
degradation of hard drive condition	7-16, 7-18
disk storage, INSIGHT Manager	7-15
drive spanning performance	6-9
Fast-SCSI-2	1-3, 2-3, 3-1
fault tolerance	1-6
IDA-2	1-5, 2-7, 3-1
multiple hard drives, using	6-8
options	1-2
performance	
Fast-SCSI-2	6-3
IDA-2	6-11
QVision 1024/E QuickBlank feature and	2-3, 2-4, 3-1
system memory and	6-2
Hardware configuration	
checklist	2-8
illustrated	2-2
Hardware maintenance, scheduling	7-16

Hardware revisions	7-13
Hayes-compatible modem, ASR and	7-7, 7-8
HEALTH button	7-11, 7-14
Health, server	<i>See INSIGHT Server Management</i>
<i>HIMEM.EXE</i>	<i>See DOS memory manager</i>
Host number, ASPI support	5-1
Hot Fix Redirection Area	
changing the size	6-13, 6-14
configuring for large-volume hard drive subsystems	6-14
Dynamic Sector Repairing and	6-16
read-after-write verification	6-10, 6-16
striping alignment and	6-13

I

I/O ports, INSIGHT Manager	7-15
IDA-2	
alerting using Server Manager/R	7-18
Array Accelerator Status	3-12
boot disk and Fast-SCSI-2	3-14
cache buffer size and	6-12
configuration	
as boot disk	3-14
hardware	2-7
with Fast-SCSI-2	3-14
controller duplexing	1-6, 3-11

IDA-2 *Continued*

controller slot location	2-2, 2-3, 3-1
<i>CPQDA386.DSK</i>	3-13, 3-15, 6-15
critical error alerting with INSIGHT Manager	7-14
data guarding	3-12
degradation of hard drive condition	7-16, 7-18
described	1-5
device cables	2-7
disk storage, INSIGHT Manager	7-15
distributed data guarding	1-6, 3-12
COMPAQ drive mirroring	1-6, 3-12
Dynamic Sector Repairing	6-14, 6-16
fault tolerance	1-6, 6-14
Hot Fix Redirection Area	6-14
Integrated Fast-SCSI-2 and	2-7
monitoring	
with INSIGHT Manager	7-16
with Server Manager/R and INSIGHT Manager	7-18
NetWare installation	3-1, 3-11
performance tuning	6-11
read-after-write verification	6-16
Server Manager/R and	7-18
sharing interrupts with Fast-SCSI-2	2-7
slot location	2-7
split seeks	6-15
striping alignment	6-13

IDA-2 Continued

terminating the integrated SCSI bus	2-7
three logical drives	3-12
volume block size and	2-1, 6-12

IDA-2 Controller

See IDA-2

INSIGHT Manager

alerting	7-14, 7-15, 7-21
ASR	7-14, 7-15
Automatic Data Collection	7-14
available information	7-15
Critical Error Log and	7-14, 7-15
described	7-14, 7-20
Drive Threshold Exceeded alert	7-16
HEALTH button	7-11, 7-14
integrated server management features	7-14
monitoring hard drive subsystems	7-16, 7-18
monitoring server performance	6-2
Revision History Table and	7-13
scheduling hardware maintenance	7-16
Server Manager/R and	7-14, 7-15, 7-21

INSIGHT Server Management

described	1-8, 7-1, 7-20
illustrated	7-1
INSIGHT Manager	1-8
Server Manager/R	1-8

INSPECT Utility

ASR	7-7, 7-19
installation	2-9
Revision History Table and	7-13
running from a remote workstation	7-9
viewing the Critical Error Log	7-11

INSTALL.NLM

cache buffer size	6-5
installing	2-9
loading <i>CPQHLTH.NLM</i>	7-5
resynchronizing mirrored partitions	3-17
striping alignment and	6-13
<i>SYNCPTCH.NLM</i>	3-17

Installing MS-DOS Version 5.0	2-9
-------------------------------	-----

Integrated Fast-SCSI-2

See Fast-SCSI-2

Integrated server management features

ASR

configuration	7-5
<i>CPQHLTH.NLM</i> and	7-5, 7-19
described	7-2, 7-19
illustrated	7-6
<i>CPQHLTH.NLM</i> and	7-3, 7-19
described	7-1, 7-2, 7-19
enabling with EISA Configuration Utility	7-1
INSIGHT Manager and	7-14, 7-15, 7-21

<hr/>			
			I-11
<hr/>			
Integrated server management features <i>Continued</i>			
<hr/>			
Server Health Logs			
<hr/>			
Critical Error Log	7-3, 7-4, 7-11		
described	7-2		
<hr/>			
Revision History Table	7-3, 7-12		
using	7-10		
viewing remotely	7-8		
<hr/>			
Interleaved data transfers, described	1-4, 6-8		
<hr/>			
Interrupts, sharing	4-2		
<hr/>			
Invalid Packets Received, Ethernet custom statistics	4-6		
<hr/>			
Invalid Packets Received, Token Ring custom statistics	4-7		
<hr/>			
<i>ISADISK.DSK, CPQDA386.DSK</i> and	6-15		
<hr/>			
J			
<hr/>			
JMP1 Jumper		<i>See NetFlex Controller</i>	
<hr/>			
Jumpers			
<hr/>			
Fast-SCSI-2 hard drives	2-5		
NetFlex Controller	2-8		
SCSI	2-6		
<hr/>			
L			
<hr/>			
Late Collisions, Ethernet custom statistics	4-6		
<hr/>			
Line Errors, Token Ring custom statistics	4-7		
<hr/>			
Loading <i>CPQHLTH.NLM</i> and enabling ASR	7-3		
<hr/>			
Loading NIC device drivers	4-3		
<hr/>			
Loading NLMs from Server Manager/R	7-18		
<hr/>			
Lost Frame Errors, Token Ring custom statistics	4-7		
<hr/>			
M			
<hr/>			
Management PC for INSIGHT Manager	7-14		
<hr/>			
Memory manager		<i>See DOS memory manager</i>	
<hr/>			
Memory parity errors	7-11		
<hr/>			
Memory pools, performance considerations	6-1		
<hr/>			
Modem, Hayes-compatible	7-7, 7-8		
<hr/>			
<i>MONITOR.NLM</i>			
<hr/>			
Cache Buffers pool	6-20		
installing	2-9		
NIC custom statistics and	4-5		
packet receive buffers	6-20		
read-after-write verification	6-11		
resynchronizing mirrored partitions	3-18		
server performance	6-2		
<hr/>			
Monitored items, INSIGHT Manager	7-15		
<hr/>			
Monitoring server performance	6-2		
<hr/>			
MS-DOS Version 5.0, installing	2-9		
<hr/>			
Multicast Packets Received, Token Ring custom statistics	4-7		
<hr/>			
Multiple NICs, sharing interrupts	4-2		
<hr/>			
Multiple system processors	1-2		
<hr/>			
Multiple volumes	6-5		
<hr/>			

Multithreaded device drivers 6-15

N

Name Space, system memory formula 6-2

NetFlex Controller

configuration 2-8, 4-1

custom statistics 4-5, 4-6

device drivers 4-1

Ethernet 2-8, 4-5

installation 4-1

jumper settings, illustrated 2-8

loading the device driver 4-3

multiple NICs, interrupt settings 4-2

packet receive buffers

maximum 6-20

minimum 6-18

performance considerations 6-17

recommended packet sizes 6-18

slot location 2-2, 2-7, 2-8

supported frame types 4-4

Token Ring 2-8, 4-6

NetWare

booting from ASR 7-9

cache buffer size 6-4

DOS partition 2-9

drive mirroring,
Dynamic Sector Repairing and 6-16

NetWare *Continued*

installation

Fast-SCSI-2 3-1

IDA-2 3-11

monitoring with Server Manager/R 7-17

removing existing volumes 3-10

System diskettes 2-9

volume block size 6-4, 6-12

volume space available 7-17

NetWare Programs from Compaq 3-2, 3-4,
3-13, 4-1,
6-3, 6-11, 7-4

Network frame type 4-4

NIC

configuration 4-1

custom statistics 4-5, 7-17

installation 2-8

maximum packet size 6-17

minimum packet receive buffers 6-18

performance considerations 6-17

NLMs

CPQDAIA.NLM 7-18

CPQHLTH.NLM 7-2

CPQSASPI.NLM 3-2, 3-4, 3-15

INSTALL.NLM 2-9, 3-4, 3-13,
4-4, 6-5, 6-13, 7-5

loading from Server Manager/R 7-18

<hr/>		<hr/>	
NLMs <i>Continued</i>		Pools, system memory	6-1
<i>MONITOR.NLM</i>	2-9, 3-18, 4-5, 6-2, 6-11, 6-18, 6-20	Power On Self Test (POST) errors	7-18
<i>SYNCPTCH.NLM</i>	3-16, 3-17	Processor exception, ASR	7-11
<i>VREPAIR.NLM</i>	2-9		
NMIs	7-11	Q	
Non-Maskable Interrupt (NMI)	<i>See NMIs</i>	QVision 1024/E QuickBlank feature, hard drive controllers and	2-3, 2-4, 3-1
O		R	
Originate connector	2-2	RAID	1-6
		RAWV	<i>See Read-after-write verification</i>
P		Read-after-write verification	
Packet receive buffers	6-18	<i>CPQSDISK.DSK</i> device driver and	6-11
Packet size	6-17	enabling with <i>CPQSDISK.DSK</i>	6-11
Packets Discarded, Token Ring custom statistics	4-7	enabling with <i>MONITOR.NLM</i>	6-11
Pager		Fast-SCSI-2	6-10
alerting using Server Manager/R	7-18	fault tolerance and	6-16
ASR and	7-7	Hot Fix Redirection Area and	6-10, 6-16
Parity errors	<i>See Memory parity errors</i>	IDA-2	6-16
Performance considerations		NetWare compatibility and	6-11
discussed	6-1	performance impact	6-10
network communication subsystem	6-17	SET ENABLE DISK READ AFTER WRITE VERIFY parameter and	6-16
NIC	6-17	Receive Congestion Errors, Token Ring custom statistics	4-7
read-after-write verification	6-10	Recommended hardware configuration	2-1
system memory	6-1	Recommended volume block and cache buffer sizes	6-5

Redundant Array of Inexpensive Disks (RAID)
See RAID

Remote console emulation,
 Server Manager/R 7-17

Reset Boot option, ASR

booting into COMPAQ Utilities 7-8

booting into NetWare 7-9, 7-22

Resynchronizing mirrored partitions 3-17

Revision History Table

Automatic Revision Tracking (ART) 7-12

available information 7-13

described 7-3

EISA Configuration Utility 7-13

INSIGHT Manager and 7-13

INSPECT Utility and 7-13

system board and 7-3

using 7-12

S

Scatter/gather

described 1-3, 6-7

effect on performance 6-3

Scheduling hardware maintenance 7-16

SCSI devices

sharing the SCSI bus 2-5

support

8-bit 1-4

ASPI 5-1

SCSI ID

defined 2-4

drive bay numbers and 2-4, 3-9

identifying 3-9

jumper settings 2-5, 2-6

low-throughput device and 2-5

matching ID to drive bay 2-5, 3-9

prioritization 2-5

rules for assigning IDs 2-5

tape drives and 2-5

SCSI Zero Device Cable 2-7

SCSI.EXE file 3-2, 3-4, 3-14, 6-3

Security configuration, INSIGHT Manager 7-15

Server configuration, INSIGHT Manager 7-15

Server Health Logs

CPQHLTH.NLM and ASR 7-21

Critical Error Log 7-3, 7-4, 7-11

described 7-2

HEALTH button 7-11, 7-14

Revision History Table 7-3, 7-12

using 7-10

viewing remotely 7-8

Server management features
See Integrated server management features

Server management, described 7-1

Server Manager/R

Critical Error Log message 7-11

Server Manager/R *Continued*

custom statistics for NetFlex Controller	4-5
described	7-17
destination lists	7-18
IDA-2	7-17
INSIGHT Manager and loading NLMs	7-14, 7-15, 7-21 7-18
monitoring server performance	6-2
NetWare SET parameters and	7-18
NIC custom statistics	4-5
off-the-network connection	7-17
pager use	7-18
required revision for COMPAQ ProSignia	1-9, 7-17
server management	7-1
<i>SERVER.EXE</i> file	2-9, 7-9, 7-10
<u>SET parameters</u>	
Server Manager/R and	7-18
SET CACHE BUFFER SIZE	6-5
SET ENABLE DISK READ AFTER WRITE VERIFY	6-10, 6-11, 6-16
SET MAXIMUM PACKET RECEIVE BUFFERS	6-20
SET MAXIMUM PHYSICAL RECEIVE PACKET SIZE	6-17
SET MINIMUM PACKET RECEIVE BUFFERS	6-18
Setting NetFlex Controller jumpers	2-8
Setting SCSI ID jumpers	2-6

Sharing interrupts

Fast-SCSI-2 and IDA-2	2-7
NetFlex Controller and hard drive controllers	4-2
<u>Simple Network Management Protocol (SNMP)</u>	
	7-14
Software-generated interrupt detected, Critical Error Log	7-11
Split seeks, IDA-2	6-15
<i>STARTUP.NCF</i> file	3-4, 3-6, 3-8, 3-15, 6-5
<u>Statistics, custom</u>	
Ethernet	4-5
Token Ring	4-6
<u>Striping alignment</u>	
changing Hot Fix Redirection Area	6-13, 6-14
Hot Fix Redirection Area and	6-13
IDA-2	6-13
illustrated	6-14
Striping factor, EISA Configuration Utility and	3-12
<i>SU001.NCF</i> file	3-4, 3-6, 3-8
<i>SU002.NCF</i> file	3-15
<i>SYNCPTCH.NLM</i>	3-16
System board, INSIGHT Manager	7-15
System diskettes for NetWare	2-9
<u>System memory</u>	
ASR and memory parity errors	7-11
Cache Buffers pool	6-1

System memory *Continued*

hard drive subsystem and	6-2
minimum system memory formula	6-2
recommended	2-1
Total Cache Buffers and	6-2

System processor

exception	7-11
Intel OverDrive Processor	1-2
multiple	1-2
parity error	7-11

T

Tagged command queuing

described	1-4, 6-8
effect on performance	6-3

Tape drives

ASPI host number and	5-2
device cables	2-6
Fast-SCSI-2 Controller and	1-7
multiple SCSI buses and	5-2

Terminal emulation software, ASR dial-in	7-8
--	-----

Terminate connector, Fast-SCSI-2, Integrated	2-2
--	-----

Three logical drives, IDA-2	3-12
-----------------------------	------

Token Errors, Token Ring custom statistics	4-7
--	-----

Token Ring

configuring multiple controllers	4-2
<i>CPQTKNWLAN</i>	4-1, 4-3, 4-6

Token Ring *Continued*

device driver	4-1, 4-3
NetFlex Controller configuration	4-1
NICs and custom statistics	4-8
recommended packet size	6-18

Token Ring, adapter module	4-1
----------------------------	-----

Transmit Packets Queued, Token Ring custom statistics	4-7
--	-----

U

Uninterruptible Power Supply	<i>See UPS</i>
------------------------------	----------------

UPS, ASR and	7-7
--------------	-----

Using multiple hard drives	6-8
----------------------------	-----

Using Server Health Logs	7-10
--------------------------	------

Using the Critical Error Log	7-11
------------------------------	------

V

Viewing the Critical Error Log	7-11
--------------------------------	------

Volume block size

changing	6-4
----------	-----

Fast-SCSI-2	2-1, 6-4
-------------	----------

IDA-2	2-1, 6-12
-------	-----------

multiple volumes	6-5
------------------	-----

NetWare default	6-4, 6-12
-----------------	-----------

performance comparison, illustrated	6-6
-------------------------------------	-----

recommended	6-5
-------------	-----

Volume block size *Continued*

setting during volume creation	6-4, 6-13
--------------------------------	-----------

Volumes

configuring Fast-SCSI-2 and IDA-2	3-14
-----------------------------------	------

<i>CPQDA386.DSK</i> and <i>ISADISK.DSK</i>	3-11
--	------

creating	3-7, 3-10, 3-13, 3-16, 6-13
----------	-----------------------------

inability to mount	6-4, 6-5
--------------------	----------

mapping NIC device drivers	4-4
----------------------------	-----

multiple	6-5, 6-9
----------	----------

removing	3-7, 3-10
----------	-----------

<i>VREPAIR.NLM</i>	2-9
--------------------	-----

W

Workstation, packet size	6-17
--------------------------	------

Z**Zero Device Cable***See SCSI Zero Device Cable*

COMPAQ TECHNOTE ORDER FORM

Ship To:

Name: _____ Company: _____

Address: _____ Dept/Mail Code: _____

City: State/Province: _____

ZIP/Postal Code: _____ Country: _____

Phone: _____

Payment Method:

Company Check Cashier's Check VISA MasterCard American Express

Personal Check (Driver's License Number/State -- USA only): _____

Card Number: _____ Expiration: _____

Card Holder Name (please print): _____

Card Holder Signature: _____

Part Number	Title	Qty	Unit Price	Total Price
			Shipping/Handling*	
			Subtotal	
			Sales tax**	
			Total	

**For U.S orders, add applicable sales tax.

For Canadian orders, add 7% GST.

*SHIPPING AND HANDLING	U. S.	Canada	Outside U.S. and Canada
Compaq TechNote (per order)	\$3.00	CDN \$2.50	U.S. \$15.00

For more information, call:
 1-800-952-7689 (USA)
 1-800-263-5868 (Canada)
 1-317-364-7281 (Worldwide)



NO POSTAGE
NECESSARY
IF MAILED
IN THE
UNITED STATES

BUSINESS REPLY MAIL

FIRST CLASS MAIL PERMIT NO. 44 CRAWFORDSVILLE, INDIANA

POSTAGE WILL BE PAID BY ADDRESSEE

COMPAQ TECHNOTES
COMPAQ COMPUTER CORPORATION
PO BOX 4100
CRAWFORDSVILLE IN 47933-9940

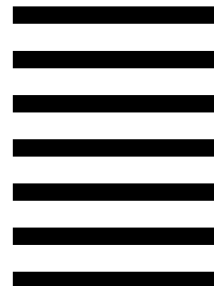

(Fold Here)

Please Tape Here

Please Tape Here

USER SURVEY

Please help us provide quality documentation by completing and returning this postage-paid form.

TechNote Title: _____

1. Overall rating of the document:
 Excellent Satisfactory Fair Poor
2. Does this document contain all the information you need? Yes No
If not, what information is missing? _____
3. Is the information appropriate to your experience? Yes No
Explain: _____
4. Are the checklists, charts, etc., provided useful? Yes No
What additional items would be helpful? _____
5. What part of this document do you use the most? _____
6. How often do you anticipate referring to this TechNote?
 Never Once Occasionally Often
7. How did you first learn about Compaq TechNotes?
 Compaq advertising Compaq Reseller/Distributor
 Compaq salesperson Compaq Customer support
 Other: *(explain)* _____
8. Does your company own any Compaq products?
 Server Desktops Portables Network laser printers
9. What operating system(s) does your company use?
 Microsoft Windows NT NetWare SCO UNIX Oracle7
 IBM LanServer Banyan VINES UnixWare
 Other *(specify)* _____
10. What is your role in the acquisition of computer products at your company?
 VP Finance Manager/Information Systems Network Administrator
 Purchaser User Other _____

(Optional) If you would like to receive future information about Compaq TechNotes, complete the following:

Name: _____ Title: _____

Company: _____

Address: _____

City: _____ State: _____ Zip: _____

If mailed outside of the U.S.A. please affix proper postage to ensure delivery.

Please fold card over and tape closed. Do not staple.



NO POSTAGE
NECESSARY
IF MAILED
IN THE
UNITED STATES

BUSINESS REPLY MAIL
FIRST CLASS MAIL PERMIT NO. 400 HOUSTON, TEXAS

POSTAGE WILL BE PAID BY ADDRESSEE

MAILCODE 090307
COMPAQ TECHNOTES
COMPAQ COMPUTER CORPORATION
PO BOX 692000
HOUSTON TX 77269-9976

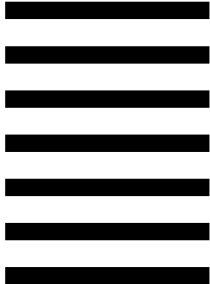

(Fold Here)

Please Tape Here

Please Tape Here