

TeleVideo®
Video Display Terminal
Operator's Manual

922

 **TeleVideo Systems, Inc.**

**TELEVIDEO®
922 VIDEO DISPLAY TERMINAL
OPERATOR'S MANUAL**

TeleVideo Document 130906-00
10 September 1984

Copyright

Copyright (c) 1984 by TeleVideo Systems, Inc. All rights reserved. No part of this publication may be reproduced, transmitted, transcribed, stored in a retrieval system, or translated into any language or computer language, in any form or by any means, electronic, mechanical, magnetic, optical, chemical, manual, or otherwise, without the prior written permission of TeleVideo Systems, Inc., 1170 Morse Avenue, Sunnyvale, California 94086.

Disclaimer

TeleVideo Systems, Inc. makes no representations or warranties with respect to this manual. Further, TeleVideo Systems, Inc. reserves the right to make changes in the specifications of the product described within this manual at any time without notice and without obligation of TeleVideo Systems, Inc. to notify any person of such revision or changes.

FCC

"Warning: This equipment generates, uses, and can radiate radio frequency energy, and if not installed and used in accordance with the instruction manual may cause interference to radio communications. It has been tested and found to comply with the limits for a Class A computing device pursuant to Subpart J of Part 15 of FCC Rules, which are designed to provide reasonable protection against such interference when operated in a commercial environment. Operation of this equipment in a residential area is likely to cause interference, in which case the user at his own expense will be required to correct the interference."

TeleVideo is a registered trademark of TeleVideo Systems, Inc. DECT[™] and VT[™] are trademarks of Digital Equipment Corporation. Tektronix[®] and Plot 10[®] are trademarks of Tektronix, Inc.

TeleVideo Systems, Inc., 1139 Karlstad Dr., Sunnyvale, California
94089 408/745-7760

TABLE OF CONTENTS

1.	INTRODUCTION	1
	Terminal Overview	1
	Graphics Option	1
	7- and 8-Bit Operation	2
	Using This Manual	2
	Organization	2
	Notices	2
2.	INSTALLATION	3
	Introduction	3
	Inspecting the 922	3
	Selecting a Good Location	3
	Installing the Terminal	4
	Connecting the Keyboard	4
	Setting the Power Select Switch	5
	Adding a European Base Plate	6
	Connecting the Terminal to a Computer System	6
	Connecting the Terminal to a Printer	9
	Plugging In and Turning On the Terminal	10
	Installation Summary	12
3.	SETTING THE OPERATING PARAMETERS	13
	What Is Set Up?	13
	The Set Up Screens	13
	Fields	14
	The Cursor	14
	Changing the Set Up Lines	14
	Entering Set Up Mode	14
	Directory Screen	15
	Display Screen	16
	General Screen	18
	Communications Screen	19
	Printer Screen	21
	Keyboard Screen	23
	Tab Screen	24
	TVS922 Screen	25
	Leaving Set Up Mode	27

4.	OPERATION	29
	Introduction	29
	The Keyboard	29
	Character Keys	30
	Special Keys	30
	Editing	35
	Composing Characters	36
	Three-Stroke Sequences	36
	Two-Stroke Sequences	37
	7- and 8-Bit Operation	42
	Control Codes	42
	Communication	42
	Communication Modes	42
	Printing	44
	The Status Line	45
5.	PROGRAMMING THE 922	47
	Introduction	47
	Using Commands in Computer Programs	47
	Changing Data Only on the Terminal's Screen	47
	Entering Commands	47
	ANSI and ASCII Commands	48
	ANSI Commands	48
	ANSI Set/Reset Mode	48
	Private Set/Reset Mode	49
	ASCII Control Codes	49
	Terminal Modes	50
	Setting the Terminal Operating Mode	50
	Control Code Mode	51
	Resetting Values	51
	Set Up Lock/Unlock	51
	Power-On Values	52
	Factory Default Values	52
	Soft Reset Values	52
	Keyboard Action	53
	Keyboard Lock/Unlock	53
	Keyclick	53
	Auto Character Repeat Mode	54
	Controlling the Display	54
	The 25th Line	54
	Cursor Attributes	54
	Text Cursor Mode	54
	Display Intensity	55
	Character Attributes	55
	Line Attributes	56
	Columns Per Line	57
	Screen Background	57
	Screen Brightness	58
	Screen Saver	58

5. PROGRAMMING THE 922 Continued	
Controlling the Cursor	59
Cursor Up	59
Cursor Down	59
Cursor Right	59
Cursor Left	59
Cursor Next Line	60
Cursor Previous Line	60
Index	60
Reverse index	60
Autowrap Mode	60
Cursor Description	61
Cursor Addressing	61
Cursor Home	61
Tabs	62
Tab Set	62
Tab Clear	62
Tab Forward	62
Tab Backward	62
Character Sets	63
Character Set Descriptions	63
Selecting Character Sets	64
Designating Hard Character Sets	64
Designating Down-Line Loadable (Soft)	65
Character Sets	
Loading Soft Font Characters	66
Invoking Character Sets Using Single Shifts	67
Editing	68
Insert/Replace Mode	68
Insert Character	68
Delete Character	68
Insert Line	69
Delete Line	69
Erase Character(s)	69
Erase in Line	70
Selective Erase in Line	70
Erase Screen	71
Selective Erase Screen	71
Character Erase Attribute	72
Erase in Field	72
Defining the Scrolling Region	72
Scrolling Mode	73
Origin Mode	74
Controlling Communication	75
Communication Modes	75
Send/Receive Mode	75
Sending Data	76

5. PROGRAMMING THE 922 Continued	
Printing	76
Print Extent	76
Screen Print	77
Auto Line Print Mode	77
Buffered Print Mode	77
Bidirectional Print Mode	78
Print Cursor Line	78
Screen Print Terminator	78
Reprogramming Key Codes	79
Cursor Key Mode	79
Keypad Mode	79
Line Feed/New Line	80
The Function Keys	80
Programming the Function Keys	81
Constructing Programming Commands for the Function Keys	82
Tests, Adjustments and Reports	83
Terminal Tests	83
Adjusting the Screen	83
Programming the Status Indicators	84
Cursor Position Report	84
Device Attribute Requests	84
Terminal Status Report	85
Printer Port Status Report	86
User Defined Keys	86
Answerback Message	86
6. TROUBLESHOOTING	87
Introduction	87
The Self Test	87
Troubleshooting Procedures	87
Checking the Fuses	90
Power Supply Fuses	90
Line Fuse	90
If You Need Assistance	91
Service Under Warranty	91
Reshipping the Terminal	91
APPENDICES	A-1
A Specifications	A-2
B Statement of Limited Warranty	A-5
C ASCII Code Tables	A-6
D Control Characters	A-13
E Set Up Mode Parameters	A-15
F ASCII, Supplemental and Special Character Sets	A-21
G VT52 Mode Commands	A-25
INDEX	X-1
QUICK REFERENCE GUIDE	Q-1

LIST OF FIGURES

1-1	922 Terminal	1
2-1	Comfortable Terminal Lighting	4
2-2	Ideal Terminal Placement	4
2-3	Connecting the Keyboard Cable	5
2-4	Location of the Power Select Switch	5
2-5	Power Select Switch Settings	6
2-6	Attaching the Optional European Base Plate	7
2-7	Pin Numbers (25-Pin RS-232 Connector)	8
2-8	Rear View of the Terminal	8
2-9	Plugging the Power Cord into the Terminal and Wall Outlet	10
2-10	Turning On the Terminal	11
3-1	Sample Set Up Screen	13
3-2	Directory Screen	15
3-3	Display Screen	17
3-4	General Screen	18
3-5	Communications Screen	19
3-6	Printer Screen	21
3-7	Keyboard Screen	23
3-8	Tab Screen	25
3-9	922 Screen	26
4-1	The 922 Keyboard	29
4-2	Character Keys	30
4-3	Special Keys	31
4-4	Erasing Data	35
4-5	Deleting Data	36
4-6	Data Flow	43
4-7	Data Sent by Send Key	44
5-1	Line Sizes	56
5-2	Scrolling Region of Double-Height Lines	73
5-3	Line Numbers Independent of Scrolling Region	74
5-4	Line Numbers Dependent on Scrolling Region	75
5-5	Example of a Programmed Function Key	82
6-1	Location of the Line Fuse	90
6-2	Good Fuse	91
6-3	Burned-Out Fuse	91

LIST OF TABLES

2-1	RS-232C Computer (DTE) Interface Connector Assignments	8
2-2	25-Pin RS-232C Printer (DCE) Interface Connector Assignments	9
2-3	9-Pin RS-232C Printer (DCE) Interface Connector Assignments	10
4-1	Function of Special Keys	31
4-2	Compose Sequences	37
4-3	Communication Modes	43
4-4	Status Line Values	45
5-1	ASCII Control Codes Recognized by the 922	49
5-2	922 Terminal Modes	51
5-3	Soft Reset States	53
5-4	Character Set Choices	63
5-5	Invoking Character Sets Using Locking Shifts	67
5-6	Cursor Key Codes	79
5-7	Effect of Keypad Modes	80
5-8	Kyn Values of Function Keys	82
6-1	Troubleshooting Terminal Problems	87
C-1	ASCII Code Chart	A-6
C-2	ASCII Control Character Abbreviations	A-6
C-3	ASCII Code Equivalents	A-7
D-1	ASCII Control Characters	A-13
D-2	Supplemental Control Characters	A-14

1. INTRODUCTION

TERMINAL OVERVIEW

TeleVideo's 922 terminal (shown in Figure 1-1) incorporates the latest advances in human-factors engineering with advanced operating features and ANSI X3.64-compatible codes. Its low-profile keyboard and unique monitor design make this terminal truly user adaptable. We designed the 922 with high priority on user convenience and productivity.

A series of set up screens let you change many of the terminal's operating parameters from the keyboard. You can incorporate the 922's operating commands into application programs or use them directly from the keyboard.

Graphics Option

You can order a graphics board and mouse for the 922 terminal. With this option you can create business, engineering, and scientific graphics using Tektronix Plot 10-compatible software or programs you write yourself.

Figure 1-1
922 Terminal

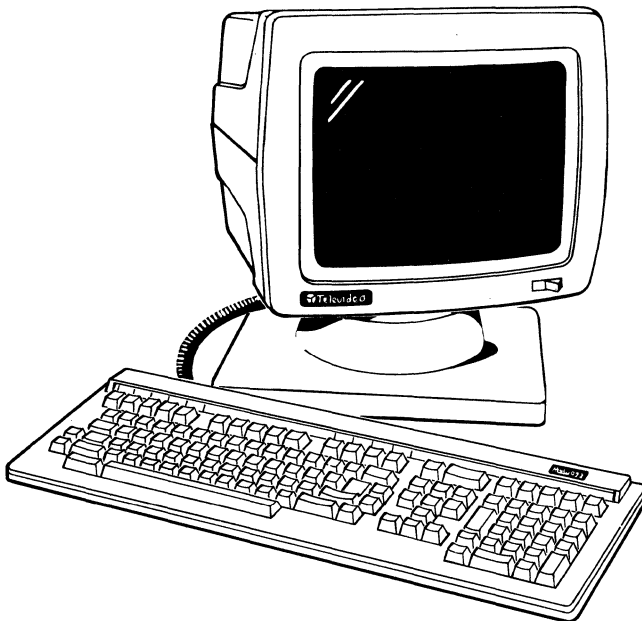

922 OM-1

7- and 8-Bit Operation

In the native 922 and VT220 modes, you can operate in either 7- or 8-bit control mode. In VT52 and VT100 modes, the terminal operates in 7-bit control mode only.

Whether you choose 7- or 8-bit control and communication modes affects the terminal's handling of control codes and how data is transmitted between terminal and host. For more information, see the section on 7- and 8-bit operation in Chapter 4.

USING THIS MANUAL

Organization

Introduction: Overview of the 922 terminal and the manual.

Installation: Selecting a site for your 922 terminal, proper installation, connecting the various parts of the terminal, selecting switch settings, and connecting the terminal to a computer and printer.

Setting the Operating Parameters: Selecting the terminal's operating characteristics, and configuring the terminal to communicate with a host computer.

Operation: The keyboard, editing, 7- and 8-bit operation, controlling communication, printing, and the status line.

Programming: Commands to control terminal emulation modes, cursor movement, tabs, keyboard action, display attributes, character sets, editing, reprogrammable keys, communication, data transmission, and terminal tests and reports.

Troubleshooting and Service: Possible problems and how to remedy them, terminal tests, and how to get assistance or service.

Appendices: 922 terminal specifications, limited warranty, and reference tables.

Index: Page-number guide to manual content.

Quick Reference Guide: Control and escape codes.

Notices

Throughout the manual, the following notices call your attention to information of special importance:

NOTE! Contains general information.

STOP! Warns you of safety hazards or possible loss of data. When you see this note, STOP and read the note before proceeding!

2. INSTALLATION

INTRODUCTION

This chapter tells you how to install the 922. You will find a summary of the installation steps at the end of the chapter.

INSPECTING THE 922

Unpack the terminal carefully and visually inspect all the parts for shipping damage.

WARNING! Do not open the case to inspect the interior unless you are a qualified technician. Opening the case exposes you to potential shock hazards.

Each packing carton should contain these items:

- Terminal
- Keyboard
- Two keyboard legend labels
- Coiled keyboard cable
- Power cable
- Operator's guide

If anything is missing or damaged, call your dealer.

You may want to keep the shipping carton and packing material in case you move or ship the terminal.

SELECTING A GOOD LOCATION

Make sure the site you choose for the 922 allows at least 4 inches (10.2 cm) of clearance above, behind, and on both sides for ventilation.

The orientation of the terminal's screen affects your comfort--reflections and bright light are the most common causes of eye strain. Choose a site with indirect lighting, away from windows and other sources of bright light, as shown in Figure 2-1.

You can avoid fatigue by selecting furniture conducive to good working posture and placing the terminal at the correct height. Figure 2-2 shows the ideal relationship between the terminal and the operator.

You need not worry about X-ray emissions: Tests performed on TeleVideo terminals by Underwriters Laboratories indicate they emit virtually no radiation and pose no health hazard.

**Figure 2-1
Comfortable Terminal Lighting**

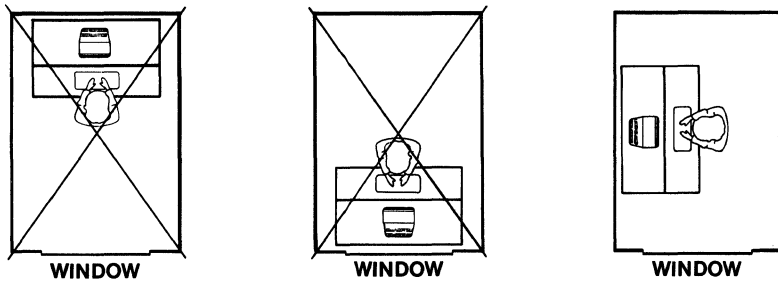

**Figure 2-2
Ideal Terminal Placement**

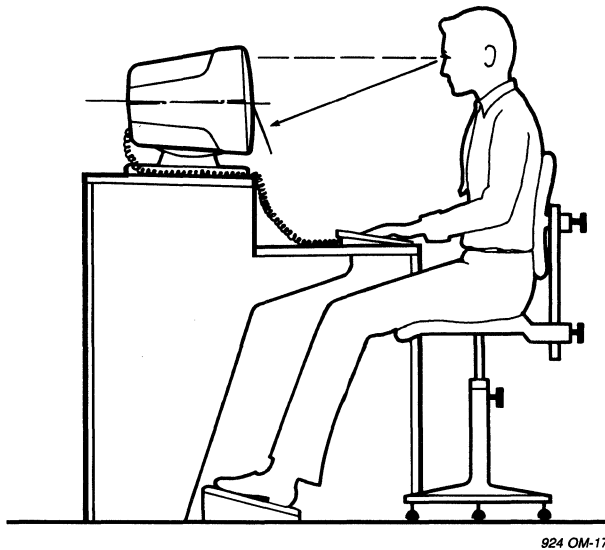

INSTALLING THE TERMINAL

Connecting the Keyboard

Insert the preprinted legend label into the bezel directly above the row of function keys. Save the other, blank label.

Plug one end of the coiled keyboard cable into the telephone-style (RJ-11) connector on the back of the keyboard case and the other end into the telephone style connector on the back of the terminal (Figure 2-3).

Figure 2-3
Connecting the Keyboard Cable

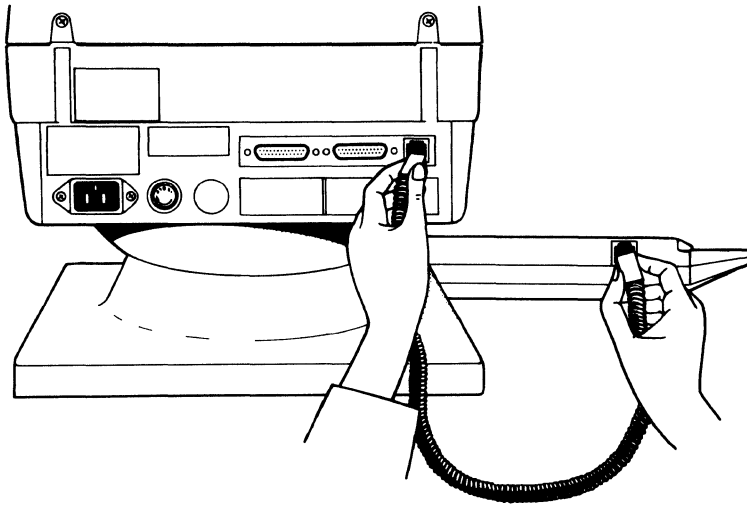

924 OM-9

Setting the Power Select Switch

Before you connect the terminal, make sure it is set to match the voltage of your electrical outlet. The terminal requires 115 volt (60 hertz) or 230 volt (50 hertz) ac power.

1. Look at the power select switch under the left rear of the terminal (Figure 2-4). A blocking strip holds the power select switch in position for either 115 volt (US) or 230 volt (international) operation.

Figure 2-4
Location of the Power Select Switch

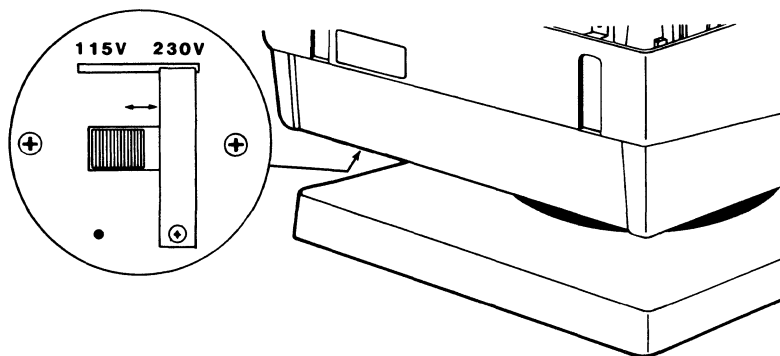

924 OM-10

2. Remove the blocking strip and, if necessary, change the power select switch to match your power source. Figure 2-5 shows the two possible switch positions.
3. Replace the blocking strip.

If you need a neutral fuse to meet international standards, ask your dealer or service technician to install it for you.

Figure 2-5
Power Select Switch Settings

115 Volt Operation

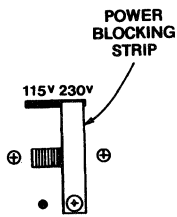

230 Volt Operation

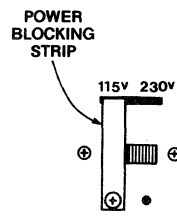

924 OM-11

Adding a European Base Plate

You can add an optional European base plate to raise the terminal's height. This base plate, shown in Figure 2-6, is available through your dealer. The only tool you need is a small Phillips screwdriver.

1. Turn the terminal on its side.
2. Remove the Phillips screw inside each rubber foot. Set the feet and screws aside.
3. Hold the European base plate against the conventional base. Install the four screws (supplied in the kit) in the small holes near the holes for the feet (Figure 2-6).
4. Position a rubber foot over each outer hole and replace the screws removed from the original base plate.
5. Turn the terminal upright.

Connecting the Terminal to a Computer System

Before you connect the terminal to a computer (or a modem), measure the distance between them. If the distance is less than 50 feet, you can use an RS-232C interface (with a 25-pin connector) between the terminal and the computer. For distances between 50 and 1,000 feet, ask your service technician to install a current loop interface.

Figure 2-6
Attaching the Optional European Base Plate

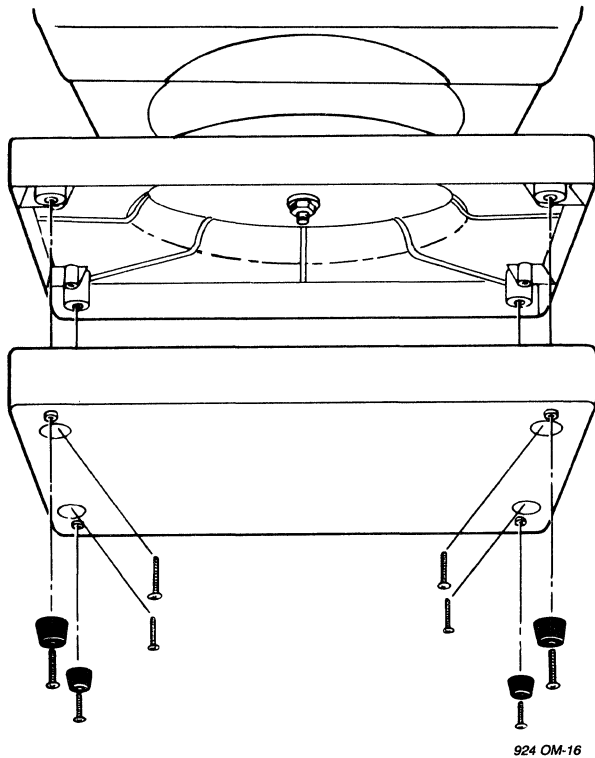

If you use an RS-232C interface, follow these steps:

1. Compare the suggested pin connector assignments, listed in Table 2-1, with those required by your computer. (Figure 2-7 shows the pin numbers assigned to the terminal's pin connectors.) If necessary, change the interface cable's pin assignments or ask your service technician to do it for you.
2. Connect the interface cable to the terminal port labeled RS232C (Figure 2-8) and to the computer's RS-232C port.

NOTE! Not all computers have a one-to-one pin compatibility with standard RS-232C pin assignments. Typically, pins 2 and 3 transmit and receive data between the terminal and the computer. Pin 7 is ground. If your terminal fails to operate properly, call the computer manufacturer for assistance in wiring the interface cable. If the pin connections are correct but the terminal still fails to operate properly, call TeleVideo for technical assistance.

Table 2-1
RS-232C Computer (DTE) Interface Connector Assignments

Pin No.	Signal Name*	Direction
1	Frame Ground	
2**	Transmit Data	Output
3**	Receive Data	Input
4	Request to Send	Output
5	Clear to Send	Input
6	Data Set Ready	Input
7**	Signal Ground	
8	Data Carrier Detect	Input
20***	Data Terminal Ready	Output

*Refer to the EIA's Standard RS-232C for signal definitions.

**The terminal requires these signals.

***Modems often require pin 20.

Figure 2-7
Pin Numbers (25-Pin RS-232 Connector)

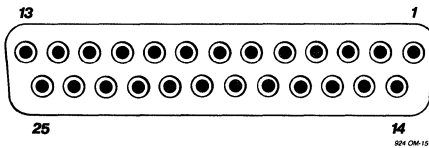
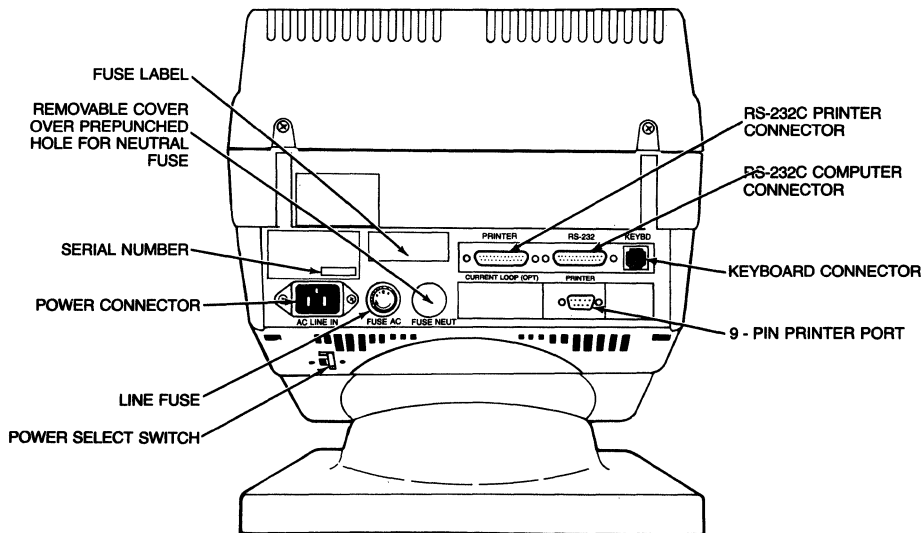

Figure 2-8
Rear View of the Terminal



922 OM-4

Connecting the Terminal to a Printer

The 922 has two RS-232C printer ports: a standard 25-pin port and a 9-pin, VT220-style port.

1. Compare your printer's pin connector configuration with the pin assignments of the terminal's printer port. Tables 2-2 and 2-3 summarize pin connector assignments for a 25-pin and a 9-pin connector, respectively.
2. Connect an RS-232C interface cable with either a 9-pin or a 25-pin connector to the terminal's 25-pin port labeled **PRINTER** or the 9-pin port (Figure 2-8) and to an RS-232C-compatible serial printer.

NOTE! Not all printers have a one-to-one pin compatibility with standard RS-232C pin assignments. Only pins 3 and 7 as well as 2 and/or 20 are required to transmit data from the terminal to the printer. If your printer fails to operate properly, call the printer manufacturer for assistance in wiring the interface cable.

Table 2-2
25-Pin RS-232C Printer (DCE) Interface Connector Assignments

Pin No.	Signal Name*	Direction
1	Frame Ground	
2	Receive Data	Input
3	Transmit Data	Output
4	Request to Send	Input
5	Clear to Send	Output
6	Data Set Ready	Output
7	Signal Ground	
8	Data Carrier Detect	Output
11**	Printer Busy	
20	Data Terminal Ready	Input

*Reference EIA Standard RS-232C for signal definitions.

**Nonstandard handshaking signal used by several printers such as Epson, Texas Instruments, and Okidata. Pin 11 is not a control line for the 922 and must be connected to pin 20. If you want to use pin 11 instead of pin 20, call a qualified service technician.

Table 2-3
9-Pin RS-232C Printer (DCE) Interface Connector Assignments

Pin No.	Signal Name*	Direction
1	Protective Ground	
2	Transmit Data	Output
3	Receive Data	Input
4	Request to Send	Input
5	Data Terminal Ready	Input
6	Data Set Ready	Output
7	Signal Ground	

*Reference EIA Standard RS-232C for signal definitions.

Plugging In and Turning On the Terminal

Now you are ready to plug in the terminal and turn it on.

1. Plug the power cable into the terminal and into a grounded wall outlet (Figure 2-9).

In the United States, use a 3-prong electrical outlet with a National Electrical Manufacturers Association (NEMA) Standard 5-15R rating. If you use a two-prong adapter, ground it with a pigtail.

2. Push the white dot on the ON/OFF switch on the front of the terminal (Figure 2-10).

Figure 2-9
Plugging the Power Cord into the Terminal and Wall Outlet

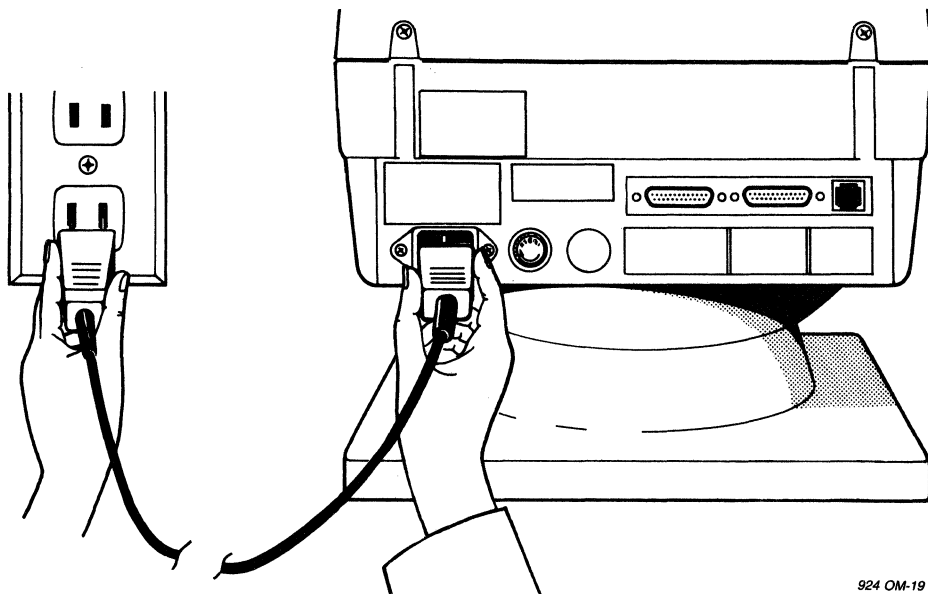

924 OM-19

Figure 2-10
Turning On the Terminal

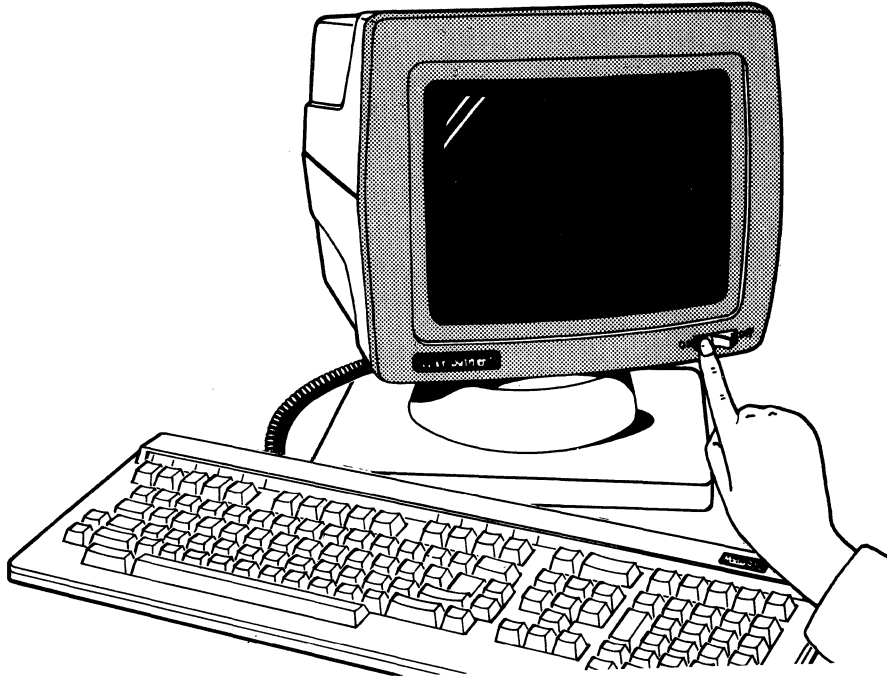

922 OM-2

3. Listen for the terminal to "beep" within a few seconds.
4. Look for the cursor in the top left corner of the screen after 10 to 15 seconds.
5. Adjust the angle of the terminal by pushing on the case until you can see the screen easily. The terminal case tilts and swivels on the base.

INSTALLATION SUMMARY

1. Plug the keyboard cable into the terminal and the keyboard.
2. Check the power select switch setting.
3. Connect the appropriate interface cable between the computer system and the terminal.
4. Attach a printer interface cable (if you are connecting a printer to the terminal).
5. Plug the power cord into both the terminal and the wall outlet.
6. Turn on the terminal, listen for the beep, and watch for the cursor to appear.

Before you try to use the terminal, read the next chapters on terminal set up and operation.

3. SETTING THE OPERATING PARAMETERS

WHAT IS SET UP?

After you install the 922, you must define the terminal's operating parameters. By changing the values of the 922's operating parameters on a series of eight set up screens, you can redefine most of the factory-set operating characteristics so they will suit your needs exactly. The parameters you can change in set up include communication and printing features, and also such functions as terminal control mode, display characteristics, terminal emulation mode, print mode, keyboard operation, and tabs. Appendix E lists all the set up parameters in alphabetical order and cross-references them to a set up screen, field type, choice of values, and factory default value.

The 922 can store operating parameters in two memories: a current (temporary operating or volatile) memory and a permanent (nonvolatile) memory. Whenever you change a parameter in set up mode, you are changing the current memory. If you save the new parameters, they are copied onto the permanent memory and used to refresh the current memory every time you turn on the terminal.

THE SET UP SCREENS

Figure 3-1 shows a sample set up screen. All eight set up screens have several things in common. They occupy the bottom eight lines of the screen. Each screen displays its title, a terminal identifier, and a firmware identification number. The line at the bottom of the screen is the status line, which is explained in Chapter 4.

Figure 3-1
Sample Set Up Screen

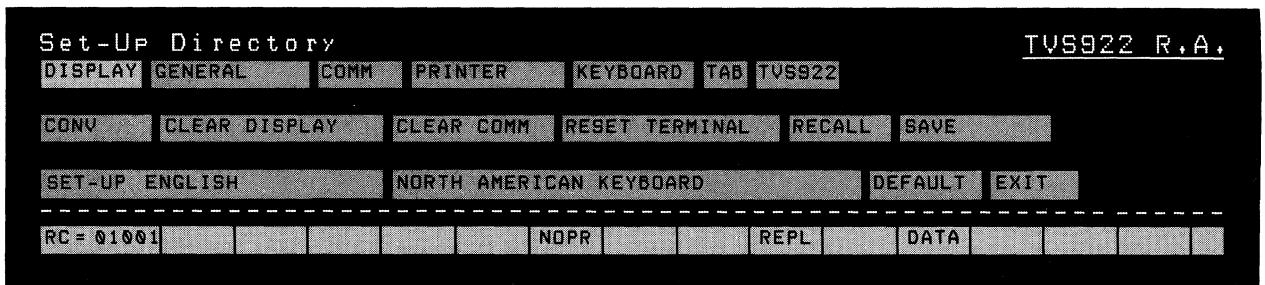

Fields

The set up screens have three types of fields that accept changes and display current values: parameter fields, text-parameter fields, and action fields (See Figure 3-1).

Parameter fields display text and at least two values you can select. Each time you press the Enter key, a new value replaces the current value on the screen and in the current memory.

Text-parameter fields accept text entries from the keyboard. Move the cursor to a text-parameter field on the screen and press the Enter key. The status (25th) line will disappear and the screen will prompt you for a text answer on that line. Type in the selected value and press the Enter key again.

Action fields have only one value. After you move to an action field, press Enter and the action happens.

The Cursor

Set up mode uses a field cursor; that is, the cursor highlights the entire field you want to change. The cursor keys move the field cursor up, down, left and right, as they do for a block cursor. To select a parameter or value on most set up screens, move the highlighting to the field of your choice and press Enter. When the cursor is in the screen's last (lower right) field, pressing the Cursor Right key moves it to the first field.

The shifted Cursor Up and Cursor Down keys control screen brightness in set up mode. To make the screen brighter, press the shifted Cursor Up key. To make it dimmer, press the shifted Cursor Down key. The level of brightness you choose will be saved when you save the values in the set up screens.

CHANGING THE SET UP LINES

Entering Set Up Mode

To enter set up mode, just press the Set Up key (function key F3) and the Directory screen will appear. You can enter set up mode from the keyboard at any time, but if you enter set up while the terminal is receiving data, the receive buffer will store incoming data until the remaining buffer capacity is down to 64 or 128 bytes (selectable in set up), and then the terminal will generate a busy signal.

The other screens list and control operating parameters for different areas:

Display	Keyboard
General	Tabs
Communications	922 mode
Printer	

Directory Screen

You see this screen when you enter set up mode. The Directory screen (Figure 3-2) allows access to other set up screens. You can easily move to any other screen by moving the field cursor (with the cursor keys) to the screen title you want and pressing the Enter key. It also contains set up fields for certain operating parameters.

Figure 3-2
Directory Screen

```
Set-Up Directory TVS922 R.A.
DISPLAY GENERAL COMM PRINTER KEYBOARD TAB TVS922
CONV CLEAR DISPLAY CLEAR COMM RESET TERMINAL RECALL SAVE
SET-UP ENGLISH NORTH AMERICAN KEYBOARD DEFAULT EXIT
-----
RC= 01001      NOPR      REPL      DATA
```

Top line Seven action fields: Display, General, Comm, Printer, Keyboard, Tab, and TVS922. If you move the cursor to one of these fields and press Enter, the corresponding set up screen appears.

Second line One parameter field, Conv/Local/Block, and five action fields: Clear Display, Clear Comm, Reset Terminal, Recall, and Save.

Conv/Local/Block: When you press Enter in this field, you replace the current value with one of the other two companion values. See Table 4-2 for more information about communication modes.

Conversational lets the 922 and the host communicate interactively; that is, each can transmit to and receive from the other.

Local stops all data transmission between the 922 and the host. The terminal stores data from the host in its buffer until you change the communication mode to block or conversational.

Block stops data transmission to the host until you press the Send key or transmit a send command from the host. The terminal can receive data, however.

Clear Display removes all data from the screen when you leave set up mode.

Clear Comm stops all communication (including printing) between the host and the terminal and clears all terminal buffers.

Reset Terminal returns several operating parameters to the values saved in nonvolatile memory. It does not change the screen display you left when you entered set up mode, your most recent selection of communication mode, and the messages or functions of user-programmed keys. Refer to Table 5-5.

Recall disconnects communication between the terminal and the host (as if you turned the power off and then on again). It clears the screen and restores the last values saved in nonvolatile memory.

Save saves (stores in nonvolatile memory) the current values in all set up screens.

Third line Two parameter fields: Set Up = and Language Keyboard; and two action fields: Default and Exit.

Set Up = lets you choose the language in which the set up screens appear: English, French (Francais), or German (Deutsch).

Keyboard lets you choose the terminal's operating mode to match the national keyboard you ordered. You can choose British, Canadian (French), Danish, Dutch, Finnish, Flemish, French/Belgian, German, Italian, North American, Norwegian, Spanish, Swedish, Swiss (French), and Swiss (German).

Default disconnects communication between the terminal and the host (as if you turned the power off and then on again) and restores the original factory default values.

Exit returns you from set up mode to normal operation.

Display Screen

The Display screen (shown in Figure 3-3) lets you choose screen display characteristics.

**Figure 3-3
Display Screen**

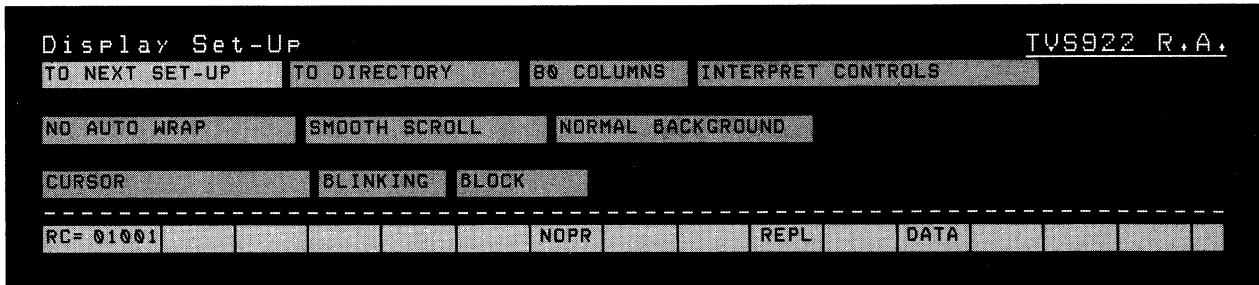

Top line Two action fields: To Next Set-Up and To Directory; and two parameter fields: Columns and Controls.

To Next Set-Up calls up the General screen.

To Directory returns you to the Directory screen.

Columns lets you choose 80- or 132-column text format.

Controls lets you determine whether the terminal interprets (acts on) control codes from the host and does not display them, or displays and does not act on the codes.

Second line Three parameter fields: Auto Wrap, Scroll, and Background.

Auto Wrap determines whether text written after the right margin continues in the first column of the next line (auto wrap) or writes over the last column in the same line (no auto wrap).

Scroll regulates how new lines appear on the screen. If you choose smooth scroll, new lines appear on the screen at a steady, controlled rate of 6 lines per second. Jump scroll lets new lines appear as quickly as the terminal receives them.

Background toggles the screen display between a dark screen with light text (normal) and a light screen with dark text (reverse).

Third line Three parameter fields: Cursor, Blinking/Steady, and Block/Underline.

Cursor determines whether or not the cursor appears on the screen.

Blinking/Steady and Block/Underline both let you choose the cursor style.

General Screen

The General screen (Figure 3-4) lets you choose a group of miscellaneous operating values.

Figure 3-4
General Screen

```
General Set-Up TVS922 R.A.
TO NEXT SET-UP TO DIRECTORY VT220 MODE 7 BIT CONTROLS
USER DEFINED KEYS UNLOCKED USER FEATURES UNLOCKED
NUMERIC KEYBOARD NORMAL CURSOR KEYS NO NEW LINE
-----
RC=01001      NPR      REPL      DATA
```

First line Two action fields: To Next Set-Up and To Directory; and two parameter fields: Mode and Bit Controls/VT100.

To Next Set-Up calls up the Communications screen.

To Directory returns you to the Directory screen.

Mode lets you select from four operating modes: TVS922, VT220, VT52, and VT100.

Bit Controls determines whether the terminal operates in 7- or 8-bit modes. In native 922 mode or VT220 mode, you can choose 7- or 8-bit control modes. VT52 and VT100 emulation modes operate only in 7-bit control modes. Whether you choose 7- or 8-bit modes affects the terminal's handling of control codes and how data is transmitted between the terminal and host. See the section on 7- and 8-bit operation in Chapter 4. If you choose VT52 or VT100 mode, this field lets you choose between US and UK character sets.

Second line Two parameter fields: User Defined Keys and User Features.

User Defined Keys lets you choose whether or not the host can change the function of keys you have programmed. You can choose keys locked or unlocked. When the keys are locked, the host cannot change them. When they are unlocked, the host can change them.

User Features lets you decide whether or not the host can change operating parameters you have set. Features affected include auto repeat, smooth/jump scroll, normal/reverse video, keyboard lock/unlock, and tabs. You can choose locked or unlocked features. When the features are locked, the host cannot change them. When the features are unlocked, the host can change them.

NOTE! Certain application programs expect to control these parameters. If your host is running one of these programs, make sure to select the unlocked value.

Third line Three parameter fields: Keypad, Cursor Keys, and New Line.

Keypad lets your numeric keypad send ASCII character codes or escape sequences to the host. You can choose between numeric and application parameters. If you choose numeric, the terminal sends ASCII character codes to the host. Application lets the application software control the cursor keys.

Cursor Keys has two values, normal and application. Normal sends standard ANSI control codes to the host. In application mode, your application software can control the keys. See Table 5-6 for the cursor key codes in both modes.

New Line lets you choose whether pressing Return (or Enter in numeric keypad mode) sends a CR and LF to the host or simply a CR.

Communications Screen

The Communications screen (Figure 3-5) lets you select the operating parameters that control how the terminal communicates with the host.

Figure 3-5
Communications Screen

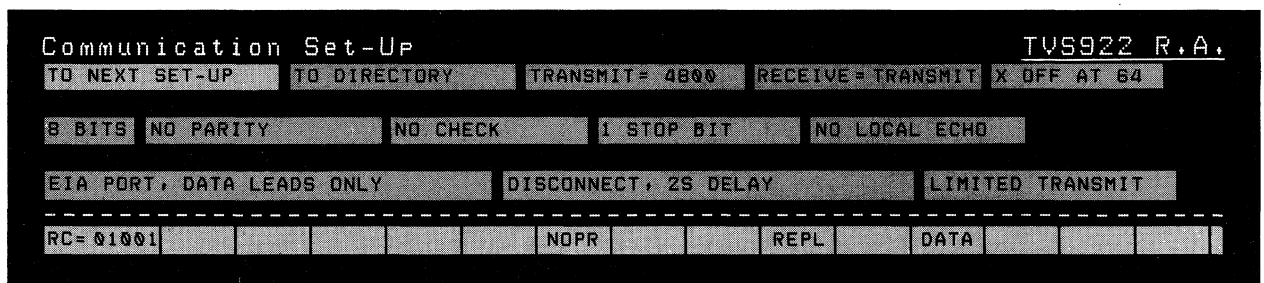

First line Two action fields: **To Next Set-Up** and **To Directory**; and three parameter fields: **Transmit=**, **Receive=**, and **XOFF**.

To Next Set-Up calls up the Printer screen.

To Directory returns you to the Directory screen.

Transmit= controls the rate at which the 922 sends data to the host. You must set the terminal transmission speed to match the speed at which the computer can accept data. You can choose 75, 110, 150, 300, 600, 1200, 2400, 4800 (default), 9600, and 19200 baud.

Receive= controls the terminal's rate of accepting data from the computer. This speed must equal the computer's data transmission speed. Possible choices include 75, 110, 150, 300, 600, 1200, 2400, 4800, 9600, and 19200 baud and **Transmit**. The default is **Receive = Transmit**.

NOTE! The terminal's transmit and receive rates do not need to be the same.

XOFF lets you disable the X-On/X-Off flow control, or set the X-Off point. Your choices include X-Off at 64, X-Off at 128, none, and DTR.

Second line Five parameter fields: **Bits**, **Parity**, **Parity Check**, **Stop Bit**, and **Local Echo**.

Bits controls the word length (character format) the 922 uses to communicate with the host. You can choose either 7- or 8-bit words. The default is 8 bits. See the section on 7- and 8-bit operation in Chapter 4.

Parity includes even, odd, space, mark, and no parity (default).

Check values are check and no check. This determines whether or not the terminal checks the parity of data received from the host.

Stop Bit lets you control the number of stop bits in the data word. One stop bit is the default value; two stop bits is the other option.

Local Echo controls the display of data on the 922 screen in conversational mode. If you select the default value, no local echo, the keyboard sends data to the host only. If you select local echo, the keyboard sends data to both the 922 screen and the host.

Third line Three parameter fields: **Port**, **Disconnect**, and **Transmit**.

Port controls the kind of port the 922 uses to communicate with the host. You can choose between EIA port, data leads only (default); EIA port, modem control; and 20 mA port.

Disconnect causes a disconnect between the terminal and the host when Data Carrier Detect is lost for either 60 ms or 2 seconds (default).

Transmit controls character transmission speed. If you select limited transmit (default), character transmission speed is never greater than 150-180 characters per second, no matter what the baud rate is. This greatly reduces the operating system's interrupt burden. Unlimited transmit removes the character transmission speed limit.

Printer Screen

The Printer screen (Figure 3-6) lets you define print operation parameters.

Figure 3-6
Printer Screen

```
Printer Set-Up                                     TVS922 R.A.
TO NEXT SET-UP  TO DIRECTORY  SPEED= 4800
NORMAL PRINT MODE  B BITS  NO PARITY  1 STOP BIT
PRINT FULL PAGE  ASCII/U.K. ONLY  NO TERMINATOR
-----
RC= 01001  NOPR  REPL  DATA
```

First line Two action fields: **To Next Set-Up** and **To Directory**; and one parameter field: **Speed=**.

To Next Set-Up calls up the Keyboard screen.

To Directory returns you to the Directory screen.

Speed= lets you choose the rate at which the 922 communicates with the printer. Your choices include 75, 110, 150, 300, 600, 1200, 2400, 4800 (default), 9600, and 19200 baud.

Second line Four parameter fields: **Print Mode**, **Bits**, **Parity**, and **Stop Bit**.

Print Mode selects the printer's operation mode. You can choose one of four print modes: normal print (default), buffered, auto print, and bidirectional. See Chapters 4 and 5 for more information about printing modes.

Normal print mode enables normal operation of the Print Screen key (F2).

Buffered mode gives you two choices: transparent print and copy print. Buffered transparent print mode lets all data from the computer pass through the terminal to the printer without being displayed on the screen. Buffered copy print mode lets any data from the keyboard or the host appear on the screen and be printed on the printer.

Auto print mode tells the terminal to send the current line of text to the printer whenever it receives a vertical tab, line feed, or form feed code. The cursor moves to the next line. The Print Screen key also functions in this mode.

Bidirectional printing mode enables two-way communication between devices attached to the terminal's computer and printer ports. Both devices must have the same baud rate, parity, word structure (bit mode), and stop bits.

Bits behaves like the Bits field in the Communications screen, except that it selects the character format used by the printer port. For a discussion of the 922's 7- and 8-bit operation, see Chapter 4.

Parity Choices include no parity, mark parity, space parity, even parity, and odd parity.

Stop Bits also behaves like the Stop Bits field in the Communications set up screen. You can choose the number of stop bits: one (default) or two, to match the number used by the printer.

Third line Three parameter fields: Print Full Page/Scroll Region, Printed Data Type, and Terminator.

Print Full Page/Scroll Region lets you choose the amount of text on the screen to be printed during a print page operation: the full page (default), or the scrolling region.

Printed Data Type specifies the character sets that the printer will receive: ASCII/U.K. only (default); ASCII/U.K., line drawing; or all characters (if your terminal needs to support both multinational and line drawing character sets).

Terminator determines whether or not the 922 sends a form feed terminator (=FF) at the end of each print page operation. No terminator is the default value.

Keyboard Screen

The Keyboard screen (Figure 3-7) controls keyboard operation features.

Figure 3-7
Keyboard Screen

Keyboard Set-Up				TVS922 R.A.							
TO NEXT SET-UP	TO DIRECTORY	TYPEWRITER KEYS	CAPS LOCK								
AUTO REPEAT	KEYCLICK	MARGIN BELL	WARNING BELL	BREAK							
NO AUTO ANSWERBACK	ANSWERBACK =			NOT CONCEALED							
RC= 01001				NOPR		REPL	DATA				

First line Two action fields: To Next Set-Up and To Directory; and two parameter fields: Keys and Lock.

To Next Set-Up calls up the Tab screen.

To Directory returns you to the Directory screen.

Keys prepares the 922 for the keyboard style you attach to it. Your choices are typewriter keys (default) and data processing keys. Typewriter keys mode produces the characters on the left side of the key cap, while data processing keys mode produces the characters on the right side of the key cap.

NOTE! North American keyboards do not have characters on the left and right sides.

Lock lets you vary the operation of the Lock key. In caps lock mode (default), only the alpha keys produce capital letters when you depress the Lock key. If you choose shift lock, all character keys will produce uppercase characters if you press Lock.

Second line Five parameter fields: Auto Repeat, Keyclick, Margin Bell, Warning Bell, and Break.

Auto Repeat lets you choose whether or not a character repeats on the screen when you hold down its key. Your choices are auto repeat (default) and no auto repeat.

Keyclick controls the clicking sound made when you press the keys. Your choices are keyclick (default) and no keyclick. **Margin Bell** controls the margin bell that sounds when the cursor is eight spaces from the right margin. Options are margin bell (default) and no margin bell.

Warning Bell controls the warning bell that indicates the terminal has detected operating errors or received a CTRL G. You can select warning bell (default) or no warning bell.

Break controls the Break key function. If you choose break (default), pressing Break (F5) on your keyboard will send a break signal to the host. Choosing no break disables the break function.

Third line Two parameter fields: **Auto Answerback** and **Concealed**; and one text-parameter field: **Answerback=**.

Auto Answerback lets you choose whether or not the 922 sends an answerback message to the host. You have two choices: auto answerback and no auto answerback.

Answerback= is a text-parameter field. The default is no message. When you position the cursor on the field and press Enter, the status line changes to a text entry field. You can enter up to 30 characters in the Answerback field as terminal identifiers. To change an existing answerback message, enter the new message in the 25th line. When you press Enter, the new message will appear in the Answerback= field in place of the old one. To erase an answerback message, press Enter twice (the empty 25th line will be the new answerback message).

Concealed controls answerback message display. If you choose concealed, the word "CONCEALED" will appear in the answerback field in place of the answerback message. You can not cancel the concealed parameter to not concealed by pressing Enter when the cursor is in that field, and you cannot recover (redisplay) a concealed message. You must go back into the Answerback field and press Enter. This clears your previous answerback message and you can enter a new message on the 25th line that will no longer be concealed when you press Enter again. If you choose not concealed (default), the 922 will display all answerback messages.

Tab Screen

The Tab screen (Figure 3-8) lets you set typewriter-style tabs at any column on the display.

**Figure 3-8
Tab Screen**

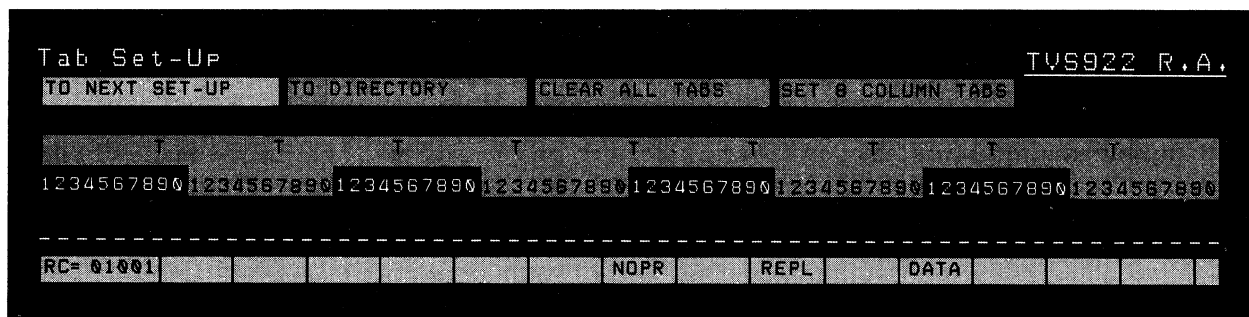

First line Four action fields: **To Next Set-Up**, **To Directory**, **Clear All Tabs**, and **Set 8 Column Tabs**.

To Next Set-Up calls up the 922 mode screen.

To Directory returns you to the Directory screen.

Clear All Tabs is an action field that clears all tab settings when you press Enter.

NOTE! You can not toggle the tab settings back on in this field. You must reset them in the next field.

Set 8 Column Tabs is an action field that sets a tab every eighth column.

Second line A ruler (80- or 132-character width) with 80 or 132 corresponding single-character tab fields above it. The cursor returns to a single-character block, and tab stop settings appear on the screen as uppercase T's. You can delete existing tab stops or set new tab stops by moving the cursor with the cursor control, Tab and Back Tab keys to the desired column. Press Enter and the cursor toggles a tab setting on or off.

TVS922 Screen

The 922 screen (Figure 3-9) appears on the screen when you position the field cursor in the 922 field and press Enter. The 922 screen lets you choose special 922 features.

NOTE! The values you choose in the 922 screen remain in effect in all operating modes.

Figure 3-9
922 Screen

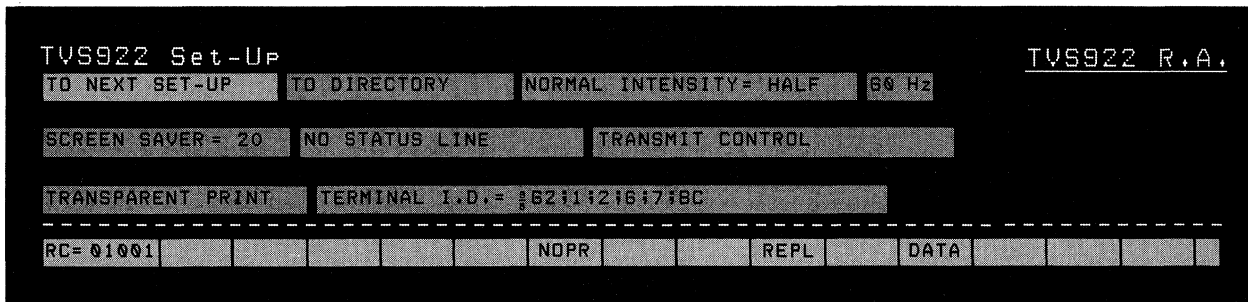

First line Two action fields: To Next Set-Up and To Directory; and two parameter fields: Normal Intensity= and Hertz.

To Next Set-Up calls up the Display screen.

To Directory returns you to the Directory screen.

Normal Intensity= controls display intensity. Your choices are half and full intensity. The default is half intensity.

Hertz regulates the rate at which the terminal refreshes the screen. You can choose between 50 hertz (international) or 60 hertz (domestic) values. If this value does not match your power line's hertz rate, the screen display may waver.

Second line Three parameter fields: Screen Saver=, Status Line, and Transmit Control.

Screen Saver= is a screen-saving feature. If you do not use the 922 for a long period, you can specify a time after which the screen will blank until you hit any key on the keyboard. Your choices include off and 5-minute intervals up to 60 minutes. Default is 20 minutes.

Status Line lets you see the status line or hides it (default) in normal operation. (The status line is always displayed in set up mode.)

Transmit Control enables the 922 to accept X-On/X-Off commands from the host. The default is transmit control.

Third line One parameter field: Transparent/Copy Print, and one text-parameter field: Terminal I.D. =.

Transparent/Copy Print operates when the terminal is in buffered or bidirectional print mode.

Transparent print (default) lets the 922 send data to the printer without disturbing any other data already on the screen.

Copy print lets data from the host appear on the 922 screen as it goes to the printer.

Terminal I.D.= lets you name your 922. Default is ESC[?62;1;2;6;7;8c.

Leaving Set Up Mode

Before you leave set up mode, you will want to save the operating parameters you have chosen from the set up screens. You can save all the values by moving the cursor to the Save field in the Directory screen and pressing the Enter key.

NOTE! You can also enter CTRL S from any set up screen to save set up values.

You can leave set up mode and return to normal operation two ways:

Move the cursor to the Exit field on the third line of the Directory screen and press Enter

Press the Set Up key (F3)

4. OPERATION

INTRODUCTION

This chapter tells you what each key on the keyboard does, including the main keypad, cursor-edit keypad, numeric keypad, and function key row. It also discusses the functions of special keys.

Other sections in this chapter describe the basics of editing data, 7- and 8-bit operation, controlling communication between the terminal and a computer and printer, sending information to the computer, and printing. At the end of the chapter is a description of the status line.

You can determine the nature of most of these functions in set up, and you can program specific aspects of these functions as well as additional features using the programming commands in Chapter 5.

THE KEYBOARD

The keyboard is divided into four areas: main keypad, cursor-edit keypad, numeric keypad, and function keypad. Figure 4-1 shows the 922 keyboard.

Figure 4-1
The 922 Keyboard

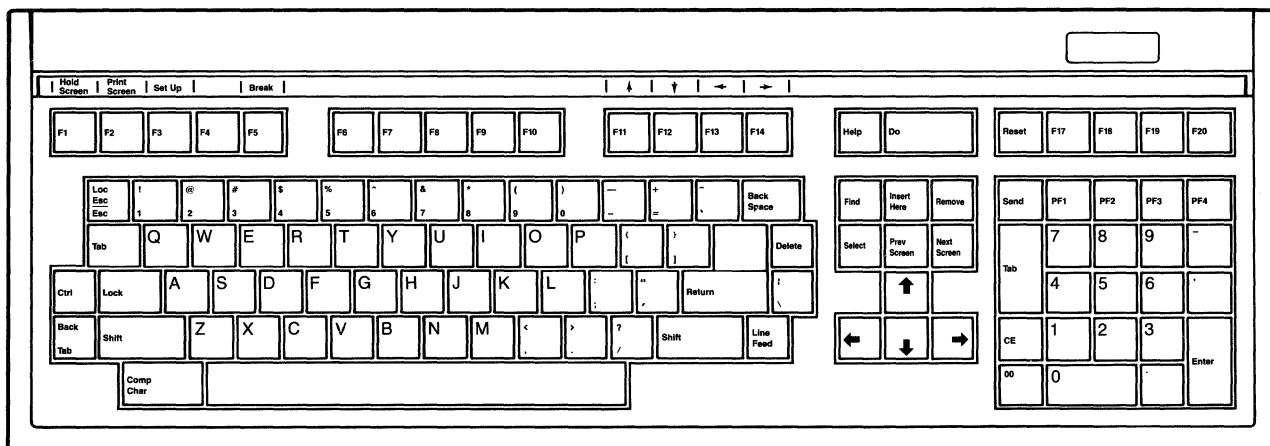

The 922 keyboard has two types of keys:

Character keys

Special keys that control the terminal's operations and its communications with a computer and printer

Character Keys

The unshaded keys in Figure 4-2 are the character keys. They include the alphabet, numbers (0 through 9), punctuation marks, mathematical symbols, and the space bar. The character keys are located on the main keypad and the numeric keypad only. They repeat when pressed for more than one-half second (unless you reprogram their repeating action using commands in Chapter 5).

Figure 4-2
Character Keys

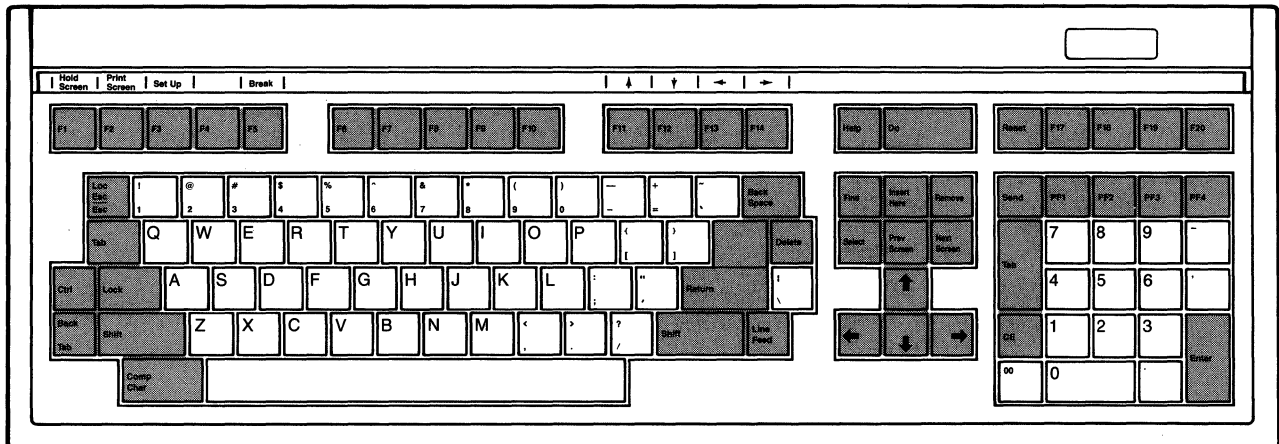

Special Keys

Table 4-1 summarizes the functions of the special keys shown unshaded in Figure 4-3. Many of these keys also repeat when pressed for more than one-half second. Table 4-1 notes those that do not. You can also reprogram the repeating action of these keys.

The terminal's modes of operation, such as set up and autowrap, can change the effect of many keys. Different modes of operation are described in Chapters 3 and 5 (and you might look through the index to locate more information on each key's action).

**Figure 4-3
Special Keys**

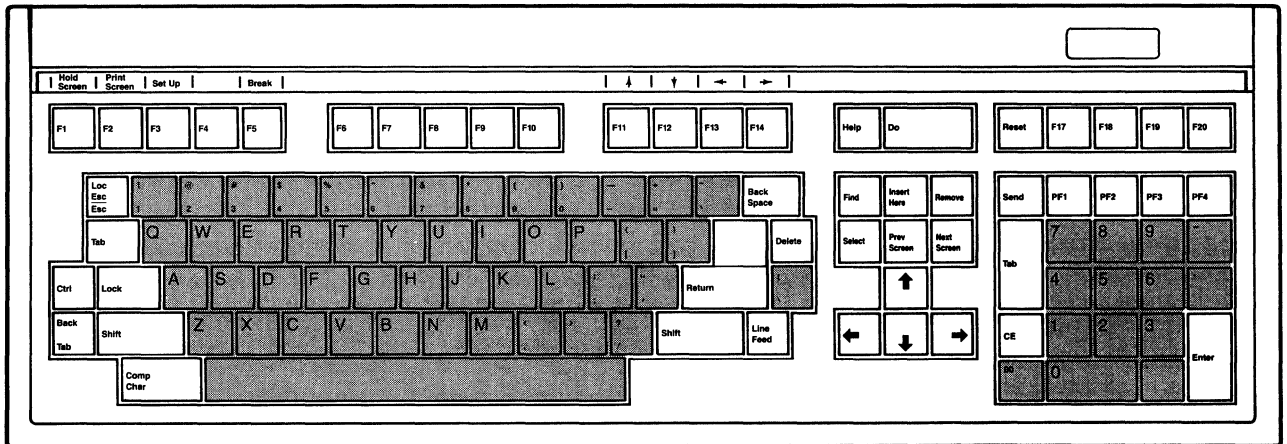

If you reprogram the function keys, you can write in names above the corresponding keys on the keyboard legend label. The names already printed on the label are the default values of the corresponding function keys. If you reprogram those keys, you can write your chosen values on the other, unprinted label and insert it into the bezel.

**Table 4-1
Function of Special Keys**

Key Name	Effect
Back Space	Moves the cursor left one character. Same effect as Cursor Left key.
Back Tab	Moves the cursor left to a typewriter-style stop. Operates in 922 mode only.
Break (F5)	Brings the transmitted data line to the space state for 250 milliseconds. You can disable the Break key by changing the set up menu. Does not repeat.
Ctrl Break	Sends an answerback character string to the host.
Shifted Break	Disconnects terminal from DTR (data terminal ready) and RTS (request to send) lines for 250 milliseconds.
CE (clear entry)	Erases the field between the previous and the next tab stops. Returns the cursor to the previous tab stop. Operates in 922 mode only. Does not repeat.

Table 4-1
Continued

Key Name	Effect
Compose Character	Lets you create supplemental characters not directly available from the keyboard. See the section on composing characters in this chapter.
Ctrl (control)	Used with another key to generate normally undisplayed control codes, Ctrl key sequences sometimes cause the terminal and/or computer program to take special action. When the ctrl key is used with specific alphanumeric or symbol keys, the output data of the typed character is changed. Has no effect when used alone. Always used simultaneously with another character. Hold the Ctrl key down while pressing the other key. (Similar in action to the Shift key.)
Cursor Left	Moves the cursor left one character within the same line. Stops at the left margin.
Cursor Up	Moves the cursor up one line within the same column. Stops at the upper boundary of scrolling region.
Cursor Right	Moves the cursor right one character within the same line. Stops at the right margin.
Cursor Down	Moves the cursor down one line within the same column. The cursor stops on the bottom line of the scrolling area.
Delete	Generates a delete code (hex 7F). Your computer program determines the effect of this code.
Do	Same as keys F6-F10.
ENTER	In numeric keypad mode, same as Return key. Each sends a carriage return (CR) or carriage return and line feed (LF) code, depending on what you choose in set up. In application keypad mode, sends ESC O M.
Esc (escape)	Sends the escape code to the computer (momentarily escaping from the application program) so you can use a special feature or function. The Esc key introduces an escape sequence. Does not repeat.

**Table 4-1
Continued**

Key Name	Effect
Find	The application software running on your host defines the function of this key. Operates only in 922 and VT220 modes.
F4	No function is assigned to this key.
F6-F10	Send a programmable message in 922 mode. In VT220 mode, send a nonprogrammable code sequence whose function is determined by your application program.
Shifted F6-F10	Programmable in both VT220 and 922 modes.
F11	Acts as a Cursor Up key in VT52/100 mode; same functions as F6-F10 in VT220 and 922 modes.
F12	Acts as a Cursor Down key in VT52/100 mode. Same as F11 in other modes.
F13	Acts as a Cursor Left key in VT52/100 mode. Same as F11 in other modes.
F14	Acts as a Cursor Right key in VT52/100 mode. Same as F11 in other modes.
F17-F20	See F6-F10, shifted and unshifted.
Help	Same as F6-F10.
Hold Screen (F1)	Temporarily stops the screen from displaying any new data. Press once to hold and press again to release. Does not repeat.
Insert Here	The application software running on your host defines the function of this key. Operates only in 922 and VT220 modes.
Line Feed	Moves the cursor down one line within the current column. Scrolls at the bottom of the scrolling region.
Loc Esc (shifted Esc)	Causes an escape sequence to change only the terminal, without sending the code to the computer. Does not repeat.

Table 4-1
Continued

Key Name	Effect
Lock	Causes the terminal to send an uppercase character code for any alpha or alphanumeric key pressed, depending on the parameter you choose in set up. Press once to lock and press again to release. Does not repeat.
Next Screen	The application software running on your host defines the function of this key. Operates only in 922 and VT220 modes.
PF1-PF4	The application software running on your host defines the functions of these keys.
Prev Screen	The application software running on your host defines the function of this key. Operates only in 922 and VT220 modes.
Print Screen (F2)	Sends contents of the screen to the printer in normal or auto print modes.
Remove	The application software running on your host defines the function of this key. Operates only in 922 and VT220 modes.
Reset	Has no effect when pressed alone. When pressed with Ctrl key, Reset returns the 922 to the operating values in its nonvolatile memory (as if you turned the power off and then on again). Does not repeat.
Return	Sends a carriage return (CR) or carriage return and line feed (LF) code to the computer, depending on what you choose in set up. Does not repeat.
Select	The application software running on your host defines the function of this key. Operates only in 922 and VT220 modes.
Send	Sends all data between home and the cursor to the computer when the terminal is in block mode. Does not repeat.
Set Up (F3)	Press once to enter set up mode and display menu. Press again to return to previous screen display. Does not repeat.

Table 4-1
Continued

Key Name	Effect
Shift	Selects the upper character inscribed on a key, changes the operation of most special keys, and capitalizes letters. Use simultaneously with another key. Has no effect when used alone. Does not repeat.
Tab	Moves the cursor forward to the next typewriter-type tab stop. Duplicated on both keypads.
Shifted Tab	Sets a typewriter-style tab stop at the cursor.

EDITING

Many of the special keys described in Table 4-1 make it easy to change data after you enter it. To remove data, you can either erase it, delete it, or clear it. You can also insert additional space characters.

Erasing replaces characters with space characters, starting at the cursor position and continuing through the end of the line or page, as shown in Figure 4-4. Erasing does not move any data.

To erase characters, you can use the CE key, or the appropriate escape sequence as shown in Chapter 5.

Figure 4-4
Erasing Data

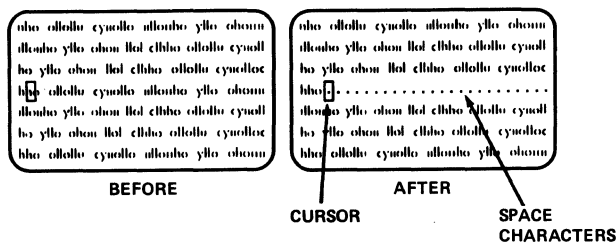

Deleting a character removes the character at the cursor position and pulls the next character into that position. See Figure 4-5.

Additional editing features are available using the programming commands in Chapter 5.

**Figure 4-5
Deleting Data**

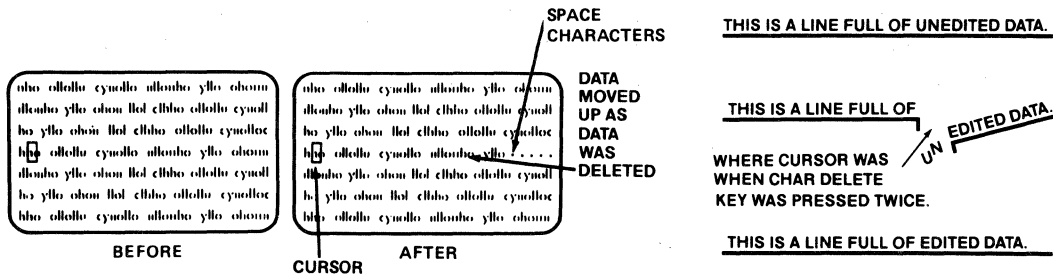

COMPOSING CHARACTERS

You can create characters from the supplemental character set, without mapping that character set into memory, by pressing combinations of standard keys. Table 4-2 lists the characters and the keystroke sequences of that create them.

The 922 has two types of character compose sequences: three-stroke, so called because you press three keys to produce the character, and two-stroke. Three-stroke sequences are available on all 922 keyboards. Two-stroke sequences are not available on the North American keyboard.

Three-Stroke Sequences

Follow this procedure for a three-stroke compose sequence:

1. Locate the character you want to create in column 1 of Table 4-2.
2. Press the Compose Character key on your keyboard. If you have displayed the status line, COMP appears in the 14th field, showing the terminal is in compose mode.
3. Type the two characters from the second column of Table 4-2 that correspond to the character you want to create. If you want to interrupt the sequence without creating a character, press the Back Space key. When you have created the character or pressed the Back Space key, the COMP field of the status line goes blank, indicating the terminal is no longer in compose mode.

If you enter an invalid sequence, the sequence aborts and the terminal's bell sounds.

Two-Stroke Sequences

You do not use the Compose Character key in a two-stroke sequence. Instead, you enter a nonspacing diacritical mark followed by a standard character. Nonspacing diacritical marks (illustrated in Table 4-2) are the grave accent, acute accent, circumflex accent, tilde mark, diaeresis mark (umlaut), and ring mark.

NOTE! Two-stroke sequences are not available on the North American keyboard.

For a two-stroke sequence, follow this procedure:

1. Locate the character you want to create in Table 4-2. Check the third column to see if you can create that character with a two-stroke sequence (two-stroke sequences cannot create all the characters in Table 4-2). If you cannot, use a three-stroke sequence.
2. Enter the first character listed (usually a diacritical mark) in the third column. When you press the key, the compose indicator comes on in the status line.
3. Press the second character in the third column.

NOTE! You must press the keys in the two-stroke sequence in the exact order shown in the table.

Table 4-2
Compose Sequences

Character	Sequence	
	Three-Stroke	Two-Stroke
" quotation mark	" <sp>	.. <sp>
# number sign	++	' <sp>
' apostrophe	' <sp>	' <sp>
@ commercial at	a a or A A	
[opening bracket	((
\ backslash	// or /<	
] closing bracket))	
^ circumflex	^ <sp>	^ <sp>
' single quote	' <sp>	' <sp>

Table 4-2
Continued

Character	Sequence	
	Three-Stroke	Two-Stroke
{ opening brace	(-	
} closing brace)-	
~ tilde	~ <sp>	~ <sp>
¡ inverted !	!!	
¢ cent sign	c/ or C/ or c or C	
£ pound sign	l- or L- or L= or L=	
¥ yen sign	y- or Y- or y= or Y=	
§ section sign	so or SO or S! or s! or S0 or s0	
¤ currency sign	xo or XO or x0 or X0	
© copyright sign	co or CO or c0 or C0	
a feminine ordinal indicator	a_ or A_	
<< angle quote mark left	<<	
° degree sign	0^ or <sp>* or <sp> o	o <sp>
± plus/minus sign		
² superscript 2	2^	
³ superscript 3	3^	
μ micro sign	/u or /U	
¶ paragraph sign	p! or P!	
¹ superscript 1	1^	
· masculine ordinal indicator	o_ or O_	

Table 4-2
Continued

Character	Sequence	
	Three-Stroke	Two-Stroke
>> angle quotation mark right	>>	
1/4 fraction one-quarter	1 4	
1/2 fraction one-half	1 2	
¿ inverted ?	??	
À A grave	A`	`A
Á A acute	A'	'A
Â A circumflex	A^	^A
Ã A tilde	A~	~A
Ä A umlaut	A" or A	A
Å A ring	A* or A	A
Æ AE ligature	AE	
Ç C cedilla	C,	
È E grave	E`	`E
É E acute	E'	'E
Ê E circumflex	E^	^E
Ë E umlaut	E" or E	E
Ì I grave	I`	`I
Í I acute	I'	'I
Î I circumflex	I^	^I
Ï I umlaut	I" or I	I
Ñ N tilde	N~	~N

Table 4-2
Continued

Character	Sequence	
	Three-Stroke	Two-Stroke
Ò O grave	O`	`O
Ó O acute	O'	'O
Ô O circumflex	O^	^O
Ö O umlaut	O" or O	O
Œ OE ligature	O E	
Ù U grave	U`	`U
Ú U acute	U'	'U
Û U circumflex	U^	^U
Ü U tilde	U~	~U
Û U umlaut	U" or U	U
ÿ Y umlaut	Y" or Y	Y
ß German small sharp s	ss	
à a grave	a`	`a
á a acute	a'	'a
â a circumflex	a^	^a
ã a tilde	a~	~a
ä a umlaut	a" or a	a
å a ring	a* or a degree sign	a
æ ae ligature	a e	
ç c cedilla	c ,	
è e grave	e`	`e
é e acute	e'	'e
ê e circumflex	e^	^e
ë e umlaut	e" or e	e
ì i grave	i`	`i

**Table 4-2
Continued**

Character	Sequence	
	Three-Stroke	Two-Stroke
í i acute	i'	'i
î i circumflex	i^	^i
ï i umlaut	i" or i	i
ñ n tilde	n~	~n
ò o grave	o`	`o
ó o acute	o'	'o
ô o circumflex	o^	^o
õ o tilde	o~	~o
ö o umlaut	o" or o	o
œ oe ligature	o e	
ø o slash	o/	
ù u grave	u`	`u
ú u acute	u'	'u
û u circumflex	u^	^u
ü u umlaut	u" or u	u
ÿ y umlaut	y" or y	y

NOTE! The following characters are treated as equivalent when used in three-stroke sequences:

- Diastasis mark (umlaut) and double quote "
- Acute accent and apostrophe '
- Grave accent and single quote `
- Circumflex accent and circumflex character ^
- Tilde mark and tilde character ~
- Ring mark and asterisk * or degree

7- AND 8-BIT OPERATION

The terminal's 7- and 8-bit modes affect both how the terminal handles control codes and how the terminal and host communicate. Under the ANSI standard, a data word can use 7 or 8 bits. Seven-bit operation permits use of the standard 128 ASCII characters (32 control characters and 96 alphanumeric characters) ranging from hex 00 to 7F. Adding the eighth bit gives another 128 characters, from hex 80 to FF. See Appendix C for the control codes and supplemental character set available in 8-bit operation.

Control Codes

When the terminal is in 7-bit control mode, it can process ASCII control codes from NUL (hex 00) to US (hex 1F). Eight-bit control mode lets the terminal also accept control codes from hex 80 to hex 9F. The 8-bit mode is available only in VT220 and 922 modes only. Default is 7-bit VT220 mode.

Communication

In the 922 native and VT220 modes, both the control and communications are by default set to 7-bit operation. If you choose to have the 922 and VT220 operate in 8-bit control and communication modes, then the terminal can handle 7- and 8-bit control codes, and can transmit and receive 7- and 8-bit data and control codes. In the VT52 and VT100 modes, control and communication operate in 7 bits only. If the terminal is in 7-bit control mode with 7-bit communication, you can receive and transmit only 7-bit control codes.

Regardless of whether the terminal is in 7- or 8-bit mode, if you choose 7-bit communication, you cannot transmit 8-bit code. If you have selected 7-bit communication, your terminal cannot receive or transmit 8-bit codes, except when you are in local or block communication. You can then display the terminal's supplemental character set from the keyboard. See the section in Chapter 5 on character sets.

With the terminal in 8-bit mode, and communication set for 8 bits, you can transmit and receive 8-bit control and data codes and supplemental graphics. 8 bits is the maximum code format you can transmit or receive on the 922 terminal.

COMMUNICATION MODES

You can choose one of three communication modes for the 922:

Block

Local

Conversational

Communication modes determine when and where data goes after you enter it at the keyboard and how your terminal interacts with the computer. You can change your communication mode in the set up screens (Chapter 3). You can also select block or conversational mode with a programming command (described in Chapter 5), but not local mode.

Figure 4-6 shows how data flows in each mode. Table 4-3 describes each communication mode.

Figure 4-6
Data Flow

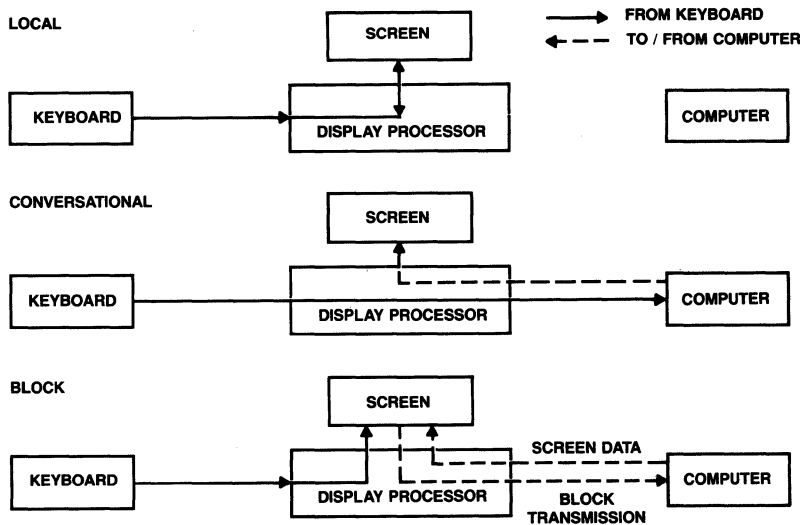

924 OM-22

Table 4-3
Communication Modes

Name	Effect
Block	Data you enter from the keyboard is displayed on the screen only, so you can check and correct it. You determine when to send the block of data to the computer. Block mode lets you make all corrections before sending data to the computer (with the Send key or an escape sequence). Once started, block mode transmits faster than conversational mode because the terminal can transmit faster than you can enter data on the keyboard.

Table 4-3
Continued

Name	Effect
Local	Turns off the port leading from the terminal to the computer. When you enter or change text, the data goes only to the screen. The terminal can not receive or transmit data.
Conversational	The terminal sends keyboard entries only to the computer. If you select local echo mode in set up, the terminal will also send data to the screen. The terminal can transmit and receive simultaneously.

The Send key sends all data on the screen, from the home position through (and including) the cursor position. See Figure 4-7.

NOTE! You could also use the escape sequences described in Chapter 5.

Figure 4-7
Data Sent by Send Key

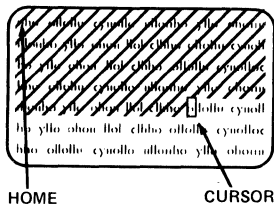

PRINTING

You can select one of four print modes during set up: normal, buffered, auto line print, and bidirectional print.

With the terminal in normal print mode (default), you can print the current screen display by pressing the Print Screen key (F2).

In buffered mode, you can display data on the screen as it is being printed (copy print), or send data directly to the printer without being displayed (transparent print).

In auto line print, the terminal sends the current line of text to the printer when it receives a vertical tab, line feed, or form feed code from the host.

The bidirectional mode allows two-way communication between the terminal's computer and printer.

THE STATUS LINE

The screen's 25th line is normally blank. You can change the 25th line in set up mode to display the status line. This line summarizes the terminal's current operating characteristics. Many fields are normally blank, and information (e.g., terminal or printer busy) appears only when appropriate. The set up screens in Chapter 3 show a typical status line. Table 4-4 lists all possible status line values for each field.

Table 4-4
Status Line Values

Area	Display	Value
1	RRCCC	Cursor position where R = Row C = Column
2	HBSY/blank	Host (computer) busy
3	CTS/blank	Clear to Send*
4	DSR/blank	Data Set Ready*
5	DCD/blank	Data Carrier Detect*
6	TBSY/blank	Terminal busy (terminal's receive buffer full during receipt of data)
7	NOPR/PBSY/PRDY	No printer/printer busy/printer ready
8	SEND/blank	Sending data in block transmission mode
9	1234/blank	Status indicator 1 = L1 2 = L2 3 = L3 4 = L4
10	REPL/NSRT	Edit control (replace/insert)
11	KLOK/blank	Terminal receives keyboard lock command
12	DONE/blank	Action completed (in set up)
13	HOLD/blank	Hold Screen key disables scrolling function (screen update)
14	COMP/blank	Terminal is in character compose mode
15	WAIT/blank	Keyboard buffer full

*When port communication is set for EIA port, modem control, and signals go low.



5. PROGRAMMING THE 922

INTRODUCTION

This chapter describes commands that both programmers and operators can use to activate features of the 922 terminal.

Using Commands in Computer Programs

You can incorporate these commands in your computer program to activate the terminal's features while the program functions.

How you incorporate these commands depends on your programming language. In general, if you enter commands as they are shown in this chapter, they will execute successfully. However, the command procedure may vary according to your programming language. The multitude of languages and syntaxes recognized by each programming language makes it impossible to show you specifically how to incorporate commands in each program. The terminal responds to the control code or escape sequence it receives, regardless of the programming language's format and syntax. If you need help with the proper syntax, refer to your programming language's documentation.

Changing Data Only on the Terminal's Screen

If you want to change only the data displayed on the screen and in the terminal's screen memory, press the Loc Esc key instead of Esc in the escape sequences in this chapter. The computer will not be aware of these commands or the changes caused by them unless you send the revised data to it.

Entering Commands

This manual shows escape sequences and control codes with a space between the characters. Do not enter this space as part of the sequence; it is included only for the sake of clarity. For example, the sequence shown as

ESC c

involves pressing only the Esc key followed by the lowercase c.

Enter the characters of the commands exactly as shown so the commands will work as you expect. Notice whether the command requires an upper- or lowercase character, a number one or a lowercase L, a zero or an uppercase O.

Always press the Ctrl key first and hold it down while you press the other key (as you would the Shift key).

Use the Esc key with one or more alphanumeric characters. Always press and release the Esc key before pressing the next key.

Each function described shows its command code in the right corner of the function description. Some functions can be activated while you are in set up mode (see Chapter 3). These are identified by the words SET UP beside the command.

Many commands show a variable value, often indicated by a capital letter P with a lowercase s or n. For programming convenience you can enter the command without the variable, and the command will then function at the lowest default value (usually zero or one). In these cases, DEFAULT is shown along with the command.

ANSI AND ASCII COMMANDS

ANSI Commands

Some of the control sequences in this chapter are ANSI standard commands. You can identify them by looking for

ESC [

Others are private control sequences that ANSI permits within its extended standards. You can identify these by looking for

ESC [?

ANSI Set/Reset Mode

Set mode	ESC [Ps ; ... ; Ps h
Reset mode	ESC [Ps ; ... ; Ps l

Ps	Name
0	Error (ignored)
2	Keyboard action
4	Insertion-replacement
12	Send-receive
20	Line feed/new line

The set/reset commands are in pairs--one sets the function (on) and the other resets it (off). You can use the ANSI control sequences singly or in strings separated by semicolons as shown above.

Private Set/Reset Mode

```
Set mode          ESC [ ? Ps ; ... ; Ps h
Reset mode       ESC [ ? Ps ; ... ; Ps l
```

Ps	Name
0	Error (ignored)
1	Cursor key
2	ANSI/VT52
3	Column
4	Scroll
5	Screen background
6	Origin
7	Autowrap
8	Auto repeat
10	Block/conversation
18	Printer form feed
19	Printer extent
22	Keyclick
23	Screen off/on
25	Text cursor enable
26	Print mode copy/transparent
27	Intensity full/half
30	Set up enabled/disabled (922 mode only)

These commands are also in sets of two--one setting the function (on) and the other resetting it (off). You can use these private control sequences singly or in strings separated by semicolons as shown above.

ASCII Control Codes

The 922 recognizes many, but not all, ASCII control codes. Table 5-1 lists those it recognizes along with their control characters, hexadecimal codes, and actions taken when the 922 reads one of these codes. The 922 ignores all other ASCII codes.

Table 5-1
ASCII Control Codes Recognized by the 922

Control Character	ASCII Code	Hex Code	Action Taken
@	NUL	00	Ignored during terminal processing.
E	ENQ	05	Transmits answerback message.
G	BEL	07	Sounds keyboard's bell.
H	BS	08	Back space.
I	HT	09	Moves cursor to the next tab stop.
J	LF	0A	Causes a line feed or a new line operation.*
K	VT	0B	Same as LF.*
L	FF	0C	Same as LF.*
M	CR	0D	Moves cursor to left margin.

Table 5-1
Continued

Control Character	ASCII Code	Hex Code	Action Taken
N	LS1 (SO)	0E	Select secondary (G1) character set.
O	LS0 (SI)	0F	Select primary (G0) character set.
Q	DC1	11	Transmission resumes if X-On/X-Off mode is enabled.
S	DC3	13	Stops transmission of all codes except X-On and X-Off if X-On/X-Off mode is enabled.
X	CAN	18	Terminates sequence if sent during an escape sequence
Z	SUB	1A	Same as CAN.
[ESC	1B	Introduces a command sequence.
	DEL	7F	Ignored.

*Action is taken even if display mode is enabled.

TERMINAL MODES

The 922 has four terminal operating modes: VT52 mode, VT100 mode, VT220 mode, and 922 mode. These modes determine which commands the terminal will recognize. When you turn on the terminal, the 922 is in the VT220 7-bit mode.

Appendix G lists the commands the terminal recognizes in VT52 mode. In the VT52 mode, the cursor control keys return to their default value.

Setting the Terminal Operating Mode

	SET UP
	DEFAULT = VT220 7 bit
Set native (922 ANSI) mode (8 bit)	ESC [6 3 " p
	or ESC [6 3 ; 0 " p
	or ESC [6 3 ; 2 " p
Set native (922 ANSI) mode (7 bit)	ESC [6 3 ; 1 " p
Set VT220 mode (8 bit)	ESC [6 2 " p
	or ESC [6 2 ; 0 " p
	or ESC [6 2 ; 2 " p
Set VT220 mode (7 bit)	ESC [6 2 : 1 " p
Set VT100 mode*	ESC [6 1 " p
Set VT52 mode*	ESC [? 2 1
Return to previous mode from VT52 mode	ESC <

*In this mode, turning on the terminal initializes the four cursor control keys to their factory default values.

Table 5-2 compares features of the four modes.

**Table 5-2
922 Terminal Modes**

Function	VT52	VT100	VT220	922
User-defined keys	No	No	Yes	Yes
Special edit and function keys operative?	No	No	Some	All
7/8 bit mode	8th bit always zero	8th bit always zero	8th bit significant	8th bit significant
Character sets	ASCII U.K. Special	ASCII U.K. Special	All VT220 character sets except U.K.	All VT220 character sets except U.K.
Function keys	Not programmable	Not programmable	Programmable unshifted (15 keys)	Programmable all (30 keys)

Control Code Mode

Set the terminal to receive 7-bit control codes	DEFAULT = 7-bit ESC <space> F
Set the terminal to receive 8-bit control codes	ESC <space> G

These commands let you change the terminal's control mode while you remain in your present terminal operating mode.

This manual shows all escape sequences in 7-bit form. However, you can convert them to 8-bit form by using the ASCII chart in Appendix C. Find the hex value of the ASCII character following ESC in the code, then add hex 40 to find the equivalent 8-bit control character. Do not enter ESC in the 8-bit code. For example, in 8-bit control mode, you can use control character CSI (hex 9B) for ESC [(hex 5B) in your programs.

RESETTING VALUES

Set Up Lock/Unlock	DEFAULT = Unlocked
Set up mode unlocked	ESC [? 30 l
Set up mode locked	ESC [? 30 h

You can lock (disable) the set up screens to prevent operating parameters from being changed. In this mode, you can view the screens but cannot change any values.

Power-On Values

Reset to power-on state

ESC c

This reset command, also called the hard reset, returns the terminal to the initial power-on state. Any values you changed in set up or using a programming command are replaced by the values in the nonvolatile memory or by default values if no nonvolatile values exist. You can also do a power-on reset by turning the terminal off and then on again or pressing Ctrl Reset. The power-on reset also:

- Disconnects the communications line
- Clears user-defined keys
- Clears any down-line loaded character set
- Clears the screen
- Returns the cursor home
- Sets the visual attributes to normal
- Sets the selective erase attribute to nonselective erasable
- Sets all character sets to the default

STOP! This reset command destroys all values not saved in nonvolatile memory!

Factory Default Values (922 mode only)

Return to factory default values

ESC [2 y

You can use this sequence when you want to reset all the operating parameters the values set at the factory.

Soft Reset Values

Soft reset

ESC [! p

The soft reset command replaces certain values you may have established in set up or by a command with the values in Table 5-3. Some replacement values vary depending on the terminal mode. This command has the same effect as selecting Reset Terminal in set up. Soft reset values ignore any values stored in nonvolatile memory (see Table 5-3).

**Table 5-3
Soft Reset States**

Function/Mode	Reset Value	Effect on Values Saved in Nonvolatile Memory
Text cursor	Visible	Not changed by soft reset
Insert/replace	Replace	Not saved in NVM
Origin mode	Absolute	Not saved in NVM
Autowrap	Off	Not changed by soft reset
Keyboard action	Unlocked	Not saved in NVM
Keypad mode	Numeric	Changed by soft reset
Cursor key mode	Normal	Changed by soft reset
Character set(s)	Terminal mode default set(s)	Not saved in NVM
Character attributes	Normal	Not saved in NVM
Selective erase attributes	Normal (erasable)	Not saved in NVM
Cursor description*		Not saved in NVM
Cursor position	Home	
Character set	Terminal mode default	
Selective erase attribute	Off	
Visual attributes	Normal	
Origin mode	Normal	
Character shift	Power up defaults	

*Applies only to subsequent restore cursor description commands.

KEYBOARD ACTION

Keyboard Lock/Unlock

	DEFAULT = Unlocked
Unlock the keyboard	ESC [2 l
Lock the keyboard	ESC [2 h

The lock keyboard command disables the keyboard and prevents anyone from entering data on the keyboard. However, unless the terminal is in local mode, the following keys can still function:

- Hold Screen
- Print Screen
- Set Up
- Reset

Keyclick

	SET UP
	DEFAULT = On
Keyclick on	ESC [? 22 l
Keyclick off	ESC [? 22 h

This mode lets you determine whether or not the keys click when you press them.

Auto Character Repeat Mode	SET UP
	DEFAULT = On
Auto character repeat on	ESC [? 8 h
Auto character repeat off	ESC [? 8 l

With the auto character repeat mode on, you can have most keys repeat when you hold the key down for more than one half second. The only keys that do not repeat in this mode are keys F1-F5, Ctrl, Shift, Lock, Compose Character, Return, CE, and Send.

CONTROLLING THE DISPLAY

The 922 screen displays 24 lines down and either 80 columns or 132 columns across on a standard 12-inch green screen. You can alter several aspects of the 922's display, including the visual attributes of the cursor and the characters, line sizes, column sizes, and screen background and intensity. You can display a 25th line either as a reverse video status line or not at all (default condition).

The 25th Line	SET UP
	DEFAULT Ps = 0
Determine 25th line visibility	ESC [0 ; Ps z

Ps	Effect
0	25th line blank
1	25th line displays the status line

When you enter a value of 1 for Ps, the status line will be displayed during normal terminal operation in reverse video.

Cursor Attributes

Define one cursor attribute	DEFAULT Ps = 0
	ESC [3 ; Ps z

Ps	Effect
0	Blinking block
1	Steady block
2	Blinking underline
3	Steady underline
4	No cursor

You can use this command sequence to establish the attributes of the cursor on the display.

Text Cursor Mode

Text cursor visible	DEFAULT = Visible
Text cursor invisible	ESC [? 25 h
	ESC [? 25 l

The text cursor mode lets you define whether or not you can see the cursor while you are using the terminal.

Display Intensity

Full intensity
Half intensity

SET UP
DEFAULT = Half
ESC [? 27 h
ESC [? 27 l

This command lets you control the intensity of the screen display. The 922 lets you choose between full intensity or half intensity, while most terminals allow only half intensity.

Character Attributes

Define character attribute of display
Define character attributes of display

DEFAULT Ps = 0
ESC [Ps m
ESC [Ps ; ... ; Ps m

Ps	Effect
0	Normal video (either increased or decreased intensity)
1	Increased intensity
2	Decreased intensity
3	Blank (invisible)
4	Underline
5	Blink
7	Reverse video
22	Normal video
23	Visible
24	Not underlined
25	Not blinking
27	Normal image (light characters, dark screen)

Normal video is determined by the value you enter in the display intensity command above.

Ps = 1 will be an invalid parameter if you chose full intensity in set up or in the display intensity command.

Ps = 2 will be an invalid parameter if you chose half intensity in set up or in the display intensity command.

Visual attributes affect only data you enter after you change the attribute(s). Data already on the screen will not be affected by new attributes.

Visual attributes do not occupy a character position. You can use more than one attribute simultaneously.

Visual attributes change the appearance of data you enter on the screen. When you are changing visual attributes, you should use the value for normal screen (Ps = 0) first unless you want to combine a new attribute with the previous attribute. For example, when most data appears light with a dark background, you can enter specific data with blinking dark characters on a light background.

Line Attributes

Select single-width line	ESC # 5
Select double-width line	ESC # 6
Select top half of double-height/double width line	ESC # 3
Select lower half of double-height/double width line	ESC # 4

The cursor's position determines which line is affected by this command, so you must place the cursor within the line you want changed before you set the line attribute.

These commands let you change the height and width of all the characters within an entire line. The command operates on a line-by-line basis.

Figure 5-1 illustrates the possible line dimensions.

Figure 5-1
Line Sizes

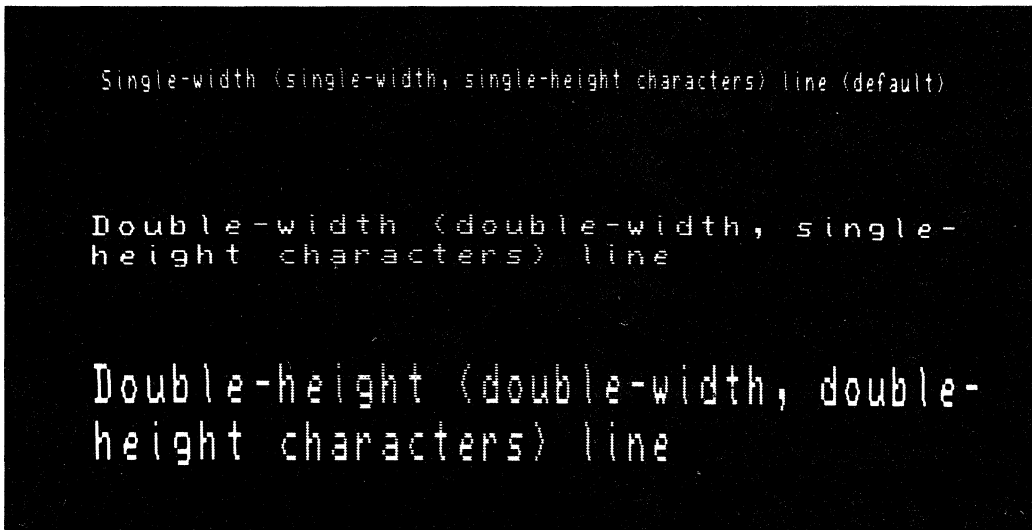

970-18

When you redefine the size of a line, you are redefining all the characters existing on that line, as well as the data you enter after you change the attribute.

Single-Width Line--A single-width line can contain either 80 or 132 columns of characters, each displayed as a single-width, single-height character.

Double-Width Line--Characters in a double-width line are twice as wide as standard characters, but their height is not changed. When you use a double-width line, you can fit only half as many characters on that line. If you define a line as an 80-character double-width line, you can display only 40 double-width characters on that line.

If you change a line from single width to double width after you have entered data, you lose the second half of the line.

If the cursor is on a character position that moves beyond the right margin, the cursor moves to the right margin of the screen.

Double-Height Line--A double-height line contains characters that are twice as high and twice as wide as standard characters. If you define a line as double height, you can fit only half as many characters on that line.

Columns Per Line	SET UP
	DEFAULT = 80
80 columns	ESC [? 3 l
132 columns	ESC [? 3 h

This command lets you change the number of characters (columns) in a line. When you change from one column setting to another, the 922 terminal:

Replaces all data on the screen with space characters.

Erases the visual attribute settings

Changes the entire screen to single-height/single-width lines.

Moves the cursor to the home position.

Cancels any defined scrolling region.

Each line can contain a maximum of either 80 or 132 characters. When you change this value, the entire page changes and the display area is restructured. You cannot mix 80- and 132- column lines within a page.

Screen Background	SET UP
	DEFAULT = Dark
Dark background	ESC [? 5 l
Light background	ESC [? 5 h

You can choose one of two screen backgrounds: Light with dark characters or dark with light characters. The default is a dark background.

You can also change the background in set up mode. The effect of a screen background command depends on how you defined the screen appearance in set up mode. If you send the terminal a command that corresponds to the value you selected in set up mode, no change occurs.

Screen Brightness

Set screen brightness DEFAULT Ps = 0
ESC [4 ; Ps z

Ps	Effect
0	Maximum brightness
1	Minimum brightness
~	
30	Maximum brightness

This command lets you set the brightness of the screen in an incremental range of 1 to 30.

Screen Saver (922 mode only) SET UP
DEFAULT Ps = 4
ESC [2 ; Ps z

Select screen saver time

Ps	Effect	Elapsed Time in Minutes Between Data Entry
0	Disabled	0
1	Enabled	5
2	Enabled	10
3	Enabled	15
~		
12	Enabled	60

With this feature, you can select a time limit during which the screen is off and you are not entering data. By turning off the display when you are not entering data, you prolong the life of the screen's phosphor. You will not lose data while the screen saver feature is active. As soon as the terminal receives data from the computer or the keyboard, the screen comes on again. (If you turn the display on again from the keyboard, the first key pressed turns the display on, and its character or function is ignored by the terminal.)

CONTROLLING THE CURSOR

The basic cursor movements--up, down, backward, forward, and next line--move the cursor through the document without loss of data. Cursor movements are not influenced by autowrap mode.

Cursor Up

Move the cursor up

DEFAULT Pn = 1
ESC [Pn A

Pn is an optional variable that defines how many lines up the cursor must move. A value of zero or one moves the cursor up one line.

The cursor up command moves the cursor upward within the current column but does not let it move above the top of the display or out of the defined scrolling region (see Defined Scrolling Region in the section on Controlling the Display). The cursor stops moving upward at the first line on the display.

Cursor Down

Move the cursor down

DEFAULT Pn = 1
ESC [Pn B

Pn is an optional variable that defines how many lines down the cursor must move. A value of zero or one moves the cursor down one line.

The cursor down command moves the cursor downward within the current column. If you have defined a scrolling region, the cursor cannot move below the bottom line of the defined scrolling region.

Cursor Right

Move the cursor right

DEFAULT Pn = 1
ESC [Pn C

Pn is an optional variable defining how many columns forward the cursor must move. A value of zero or one moves the cursor right one column.

The cursor right command moves the cursor forward within the current line. After the cursor reaches the last column position on the current line, it cannot continue.

Cursor Left

Move the cursor left

DEFAULT Pn = 1
ESC [Pn D

Pn is an optional variable that defines how many columns left the cursor must move. A value of zero or one moves the cursor left one column position.

The cursor left command moves the cursor position backward within the current line. The cursor cannot move beyond the left margin of the display; it stops in the first character position on the current line.

Cursor Next Line

Move the cursor to the next line

DEFAULT Pn = 1
ESC [Pn E (922 mode only)
or ESC E

Pn is a variable that defines how many lines down the cursor moves.

The ESC E command moves the cursor down one line.

Cursor Previous Line (922 mode only)

Move the cursor to the previous line

DEFAULT Pn = 1
ESC [Pn F

Pn is the number of lines backward the cursor must move. A value of zero or one moves the cursor up one line.

This command moves the cursor up a specified number of lines within the display. When the cursor reaches the top of the screen or the defined scrolling region, the display scrolls down.

Index

Index

ESC D

The index command moves the cursor down one line within the current column. If the cursor is on the last line of the display, the display scrolls up.

Reverse index

Reverse index

ESC M

The reverse index command moves the cursor up one line within the current column. If the cursor is already on the top line of the display, the display scrolls down one line.

Autowrap Mode

SET UP

Disable autowrap mode (no wrap)

ESC [? 7 l

Enable autowrap mode (wrap)

ESC [? 7 h

If you enable autowrap mode, the cursor automatically advances to the first character position on the next line after you enter a character in the last position of the present line.

With autowrap mode disabled, the cursor stops at the end of a line. Each character you enter at the end of a line writes over the previous character without advancing the cursor to the next line.

Cursor Description

Save the cursor description

ESC 7

You can enter this command if you need to move the cursor to another location but intend to return to the current position. This sequence saves the cursor position, character set, visual attribute(s), set shift state, origin mode, and erase state.

Restore the cursor description

ESC 8

Using this command, you can return the cursor to the position noted by the save cursor sequence (above) and display it with the visual attributes and character set that were in effect when you saved the cursor position.

Cursor Addressing

Address the cursor to line and column

DEFAULT P1/Pc = 1
ESC [P1 ; Pc H
or ESC [P1 ; Pc f

P1 is the decimal line number, and Pc is the decimal column number. A value of zero or one moves the cursor to the first line or column.

This command places the cursor at a designated line and column (called addressing the cursor). For example, if you enter a value of one for P1 and one for Pc, the cursor moves to the display's home position (line one, column one).

The effects of the cursor addressing command depend on whether you have defined a scrolling region and selected relative or absolute origin mode (see the section on Controlling the Display). If you defined the origin mode as relative, the cursor moves within the scrolling region; if you defined the origin mode as absolute, the cursor moves within the entire display.

Cursor Home

Move the cursor to home position

ESC [H
or ESC [f

The cursor home commands are simplified versions of the cursor addressing commands (above) that you can use to move the cursor to the home position in the upper left corner of the display or the scrolling region.

TABS

The 922 terminal has typewriter-style tab stops. The default tab stops are set for every eighth column position after the first column. You can change tab settings while you are in set up mode or with one of the commands listed in this section. If you try to tabulate with no tab stops set, the cursor moves to the last column position on the current line and stops.

Tab Set

Set tab stop(s) ESC H

This command sets a tab stop at the current cursor position. The tab stop is in effect until you clear it.

Tab Clear SET UP
Clear tab stop(s) DEFAULT Ps = 0
ESC [Ps g

Ps	Effect
0	Clears the tab stop at the current cursor position
3	Clears all tab stops

This command lets you clear a tab stop. To clear an individual tab stop, place the cursor on the tab stop, then enter the clear command. You can clear all tab stops regardless of the cursor position by using the command with Ps = 3.

Tab Forward

Tab forward DEFAULT Pn = 1
CTRL I
or ESC [Pn I (922 only)

Pn is the number of tab stops forward the cursor is to move.

This command lets you move the cursor forward a specified number of tab stops. When the cursor reaches the end of a line, it will not advance to the next line.

Tab Backward (922 mode only)

Tab backward DEFAULT Pn = 1
ESC [Pn Z

Pn is the number of tab stops backward the cursor is to move.

Using this command, you can specify the number of tab stops the cursor moves back. The cursor moves backward only within the present line and stops at the line's first character position.

CHARACTER SETS

The 922 has four character sets:

- Multinational set
 - 7-bit-compatible ASCII set
 - 8-bit-compatible supplemental character set
- U.K. character set
- Special character set
- Down-line loadable character set (soft font)

Table 5-4 shows which character sets are available in each terminal mode. The set designators are values assigned to each set.

Table 5-4
Character Set Choices

	VT52	Terminal Mode VT100	VT220/922
Available set designators	G0 (1)	G0, G1 (2)	G0, G1, G2, G3 (4)
Set selection	US ASCII U.K. Special	US ASCII U.K. Special	US ASCII Supplemental Special Soft font

Character Set Descriptions

The multinational character set has two parts: 128 standard ASCII characters and 128 supplemental characters. These consist of alphabetic characters with accents and diacritical marks that appear in the major Western European alphabets, plus other symbols not included in the ASCII graphics set.

The U.K. character set differs from the ASCII character set only in that the pound sign replaces the number sign (hex code 23).

The 922's special graphics set emulates the VT100 line-drawing character set. The line segments let you create a limited range of pictures while you are in text mode.

Appendix F shows the special and multinational character sets, with corresponding bit codes and hex values.

Selecting Character Sets

Before you can access a character set, you must designate specific character sets as G0, G1, G2 or G3. You can assign any character set to any of the set designators available in your current mode (see Table 5-4). You can then map these sets into GL or GR areas of the terminal's character generator (depending on your terminal mode) using the commands given later in this section for invoking character sets.

Character sets remain designated until you select another set or until you reset the terminal (see the section on resetting values). The 922's default character set is the multinational set, with the ASCII set in GL and supplemental graphics in GR. You can map the special graphics set into either GL or GR (GR is for 922 and VT220 modes only), replacing either the ASCII set or the supplemental set. If you replace the ASCII set with the special graphics set in GL, you will still have about two-thirds of the standard ASCII characters. Also, this mapping is compatible with a VT100 terminal.

Designating Hard Character Sets

You can designate hard character sets--ASCII, U.K., special, and supplemental--using the escape sequences below.

Designate standard ASCII characters			DEFAULT Ps = (
Ps	Designation	Terminal Mode	ESC Ps B
(G0	All	
)	G1	VT100, VT220, 922	
*	G2	922 and VT220	
+	G3	922 and VT220	

Designate supplemental characters			ESC Ps <
Ps	Designation	Terminal Mode	
(G0	922 and VT220	
)	G1	922 and VT220	
*	G2	922 and VT220	
+	G3	922 and VT220	

Designate U.K. characters			ESC Ps A
Ps	Designation	Terminal Mode	
)	G0	VT100*	
(G1	VT100*	

*Select U.K. characters for the VT52 mode in set up.

Designate special characters**ESC Ps 0**

Ps	Designation	Terminal Mode*
(G0	VT100, VT220, 922
)	G1	VT100, VT220, 922
*	G2	922 and VT220
+	G3	922 and VT220

*See Appendix G for the command for VT52 mode.

Designating Down-Line Loadable (Soft) Character Sets

Soft font is a character set you create and then store in memory (down load).

You can define a soft character set that may or may not replace one of the existing hard sets (ROM based-fonts). If you do replace a hard set, the new set replaces both the 80 and 132 column versions. A soft font that replaces a hard font remains in effect until you clear or redefine the soft font. You can clear the the soft font by resetting the terminal. You redefine it by using the down load soft font command. If the soft character set you define does not replace an existing hard set, then the 922 uses it in addition to the hard sets.

NOTE! You can designate soft-font character sets only in 922 and VT220 modes.

Designate down-line loadable characters**ESC Ps Dscs**

Ps	Designation
(G0
)	G1
*	G2
+	G3

Dscs is a variable that defines the character set for the soft font.

Dscs**Function****I I F****Generic Dscs**

A Dscs can consist of between 0 and 2 intermediates (I) and a final (F). Intermediates are in the range 2/0-2/15. Finals are in the range 3/0-7/14.

Invoking Character Sets Using Locking Shifts

Once you have designated the character sets, you can invoke G0, G1, G2 or G3 into GL or GR by using the locking shift control functions as shown in Table 5-5. These control functions are available for 922, VT220 and some for VT100 modes, but not for VT52 mode.

Locking shifts remain active until you send another locking shift.

Table 5-5
Invoking Character Sets Using Locking Shifts

Control Name	Coding	Function
LS0 -- Lock Shift G0	CTRL O	Invoke G0
LS1 -- Lock Shift G1	CTRL N	Invoke G1
LS1R -- Lock Shift G1, Right	ESC ~	Invoke G1 into GR. 922 and VT220. Use of this sequence can cause software incompatibility problems if you run VT100 software.
LS2 -- Lock Shift G2	ESC n	Invoke G2 into GL. 922 and VT220. Use of this sequence can cause software incompatibility problems.
LS2R -- Lock Shift G2, Right	ESC }	Invoke G3 into GR. (DEFAULT) 922 and VT220 modes.
LS3 -- Lock Shift G3	ESC o	Invoke G3 into GL. 922 and VT220. Use of this sequence can cause software incompatibility problems.
LS3R -- Lock Shift G3, Right	ESC !	Invoke G3 into GR. 922 and VT220 modes.

Invoking Character Sets Using Single Shifts

Once you have designated your character sets, you can invoke G2 or G3 into GL for one single graphic character at a time by using the single shift control function described below. These control functions are available for 922 and VT220 modes only.

All single shifts remain active for only the next single graphic character. The terminal returns the previous character set after displaying a single graphic character.

SS2 -- Single Shift G2 -- SS2 is an 8-bit control character that invokes G2 into GL for the next graphic character. You can also express SS2 as an escape sequence when coding for a 7-bit environment:

ESC N

SS3 -- Single Shift G3 -- SS3 is an 8-bit control character that invokes G3 into GL for the next graphic character. You can also express SS3 as an escape sequence when coding for a 7-bit environment:

ESC O

EDITING

Insert/Replace Mode

	DEFAULT = Replace
Enable replace mode	ESC [4 l
Enable insert mode	ESC [4 h

In insert mode the terminal pushes existing data to the right as you enter new data and drops excess data from the end of the line. In replace mode it writes over existing data with new data.

Insert Character

	DEFAULT Pn = 1
Insert space character(s)	ESC [Pn @

Pn is the number of space characters to be added.

The insert character command adds one or more space character(s) of the current visual attributes at the cursor position. This command shifts data on the line to the right starting at the cursor's position and drops the character in the last space on the line.

Delete Character

	DEFAULT Pn = 1
Delete character(s)	ESC [Pn P

Pn is the number of character positions to be deleted.

With the delete character command, you can delete a selected number of characters starting at the cursor position. A selected number of space characters with normal visual attributes appear at the end of the line. The command affects data from the cursor to the end of the line.

Insert Line

DEFAULT Pn = 1

Insert line

ESC [Pn L

Pn is the number of lines to be inserted.

This command lets you insert a defined number of lines--filled with single-height/single-width space characters with normal visual attributes--and set the line attribute to single-height/single-width. Any existing data moves down.

If you insert the new line just above the bottom margin of the display or of the defined scrolling region, you lose the data that is pushed down by the new line. If the cursor is at the bottom of the page when you insert a line, you lose a line.

Delete Line

DEFAULT Pn = 1

Delete line(s)

ESC [Pn M

Pn is the number of lines to be deleted. The line attribute is set to single height/single width. The terminal ignores the command if the cursor is outside the scrolling region.

This command lets you delete lines beginning with the cursor line. Existing data moves up and a line filled with single-height/single-width space characters and the normal visual attribute occupies the last line of the display or of the defined scrolling region.

Erase Character(s)

DEFAULT Pn = 0

Erase character(s)

ESC [Pn X

Pn defines how many characters are to be erased.

This command works in VT220 or 922 mode only. It lets you erase a specified number of characters and their visual attributes starting from and including the cursor position and replace them with space characters with default attributes. Pn = 0 or 1 erases one character. After the erasure, the rest of the characters in the line and the cursor remain in their original positions.

Erase in Line

Erase the current line

DEFAULT Ps = 0

ESC [Ps K

Ps is a value that defines how much of the line will be erased.

Ps Effect

- 0 Erase from the cursor to the end of the current line, including the cursor position. Cursor line attributes remain.
- 1 Erase from the beginning of the current line up to and including the cursor.
- 2 Erase the entire current line.

This command lets you erase data within the line on which the cursor is positioned and the visual attributes of the data. It does not clear the line attribute.

Selective Erase in Line (922 and VT220 modes only)

Erase within the current line

DEFAULT Ps = 0

ESC [? Ps K

Ps is a value that defines how much of the erasable line will be erased.

Ps Effect

- 0 Erase from the cursor to the end of the current line.
- 1 Erase from the the beginning of the current line up to and including the cursor.
- 2 Erase the entire current line.

Line and character attributes are not affected.

This command lets you erase all erasable data within the line on which the cursor is positioned. It does not affect line or visual attributes.

You can use this command to erase all but a selected portion of text from a line. Use the set character attribute command to select those characters that will not be erased.

Erase Screen

Erase the screen

DEFAULT Ps = 0
ESC [Ps J

Ps is a value that defines how much of the screen will be erased.

Ps Effect

- 0 Erase from, and including, the cursor position to the end of the screen.
- 1 Erase from the beginning of the screen up to and including the cursor position.
- 2 Erase the entire screen, change all lines to the single-width attribute. The cursor does not move.

All completely erased lines become single height, single width with default visual attributes.

With this command, you control the amount of data you can erase. If you erase a partial screen, the line attributes of all lines except the cursor line become single-height/single-width. The cursor line retains its original line attributes.

Selective Erase Screen
(922 and VT220 modes only)

Erase within the screen

DEFAULT Ps = 0
ESC [? Ps J

Ps is a value that defines how much of the erasable portion of the screen will be erased.

Ps Effect

- 0 Erase all erasable characters from, and including, the cursor to the end of the screen.
- 1 Erase all erasable characters from the beginning of the screen up to and including the cursor position.
- 2 Erase the entire screen. Line and character attributes are not affected.

You can use this command to erase all but a selected portion of text from a screen. Use the set character attribute command to select those characters that will not be erased.

The command does not affect line attributes or character attributes.

With this command, you can confine vertical scrolling to one region within the display. Figure 5-2 shows a screen containing all double-height lines, with the defined scrolling region starting at line five.

You can use jump (normal) or smooth scrolling within the defined scrolling region. Although you can only move the cursor within the defined scrolling region, your data can scroll out of that area.

The area outside the defined scrolling region is called the memory locked area (shown in Figure 5-2). Although you can still write data into this area, you cannot move the cursor into it with the cursor up or cursor down keys and data within that area cannot scroll. Whether or not you can address the cursor to the memory locked area depends on how origin mode (described in the section after next) is set.

Figure 5-2
Scrolling Region of Double-Height Lines

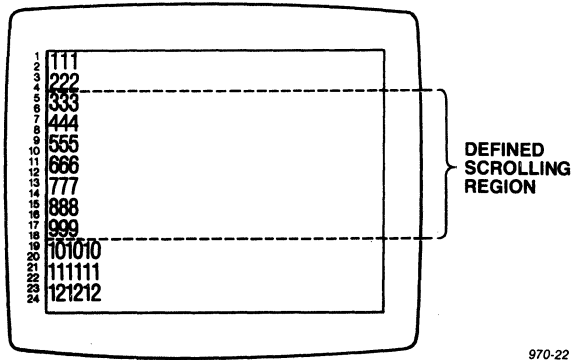

By defining a scrolling region, you also enable relative origin mode and move the cursor to the scrolling region's home position.

Scrolling Mode

Define scrolling mode as jump
Define scrolling mode as smooth

SET UP
DEFAULT = Smooth
ESC [? 4 l
ESC [? 4 h

Smooth scroll mode causes data to scroll smoothly at the steady rate of 6 lines per second. Jump scroll lets new lines appear as quickly as the terminal receives them. The default is smooth scrolling mode.

Origin Mode

Enable relative origin mode (dependent) **DEFAULT = Absolute**
Enable absolute origin mode (independent) **ESC [? 6 h**
Enable absolute origin mode (independent) **ESC [? 6 l**

After you define a scrolling region, origin mode specifies whether the home and line positions refer only to the defined scrolling region (relative) or to the entire screen area (absolute).

With relative origin mode enabled, the line numbers relate to the area within the defined scrolling region. With absolute origin mode enabled, line numbers refer to the screen lines of the entire display, regardless of any defined scrolling region.

Origin mode affects cursor movement. If you defined origin mode as relative, you cannot move the cursor outside the scrolling region from the keyboard. If you defined origin mode as absolute and you send the 922 a home command while the cursor is in the scrolling region, the cursor goes to the home position of the display.

In Figure 5-3, the line numbers are independent of the scrolling region. In Figure 5-4, a scrolling region has been defined and the line numbers are dependent on the scrolling region.

Figure 5-3
Line Numbers Independent of Scrolling Region

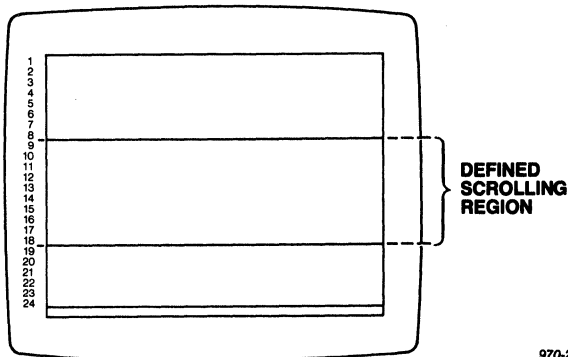

970-24

Figure 5-4
Line Numbers Dependent on Scrolling Region

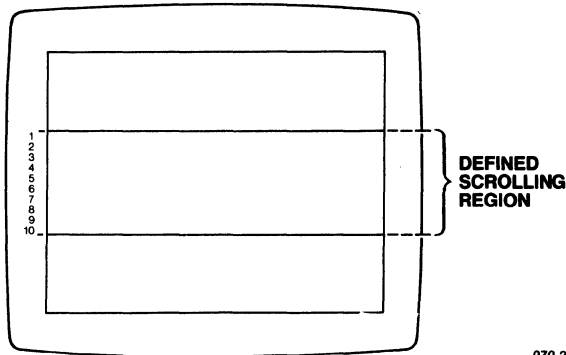

970-25

CONTROLLING COMMUNICATION

Communication Modes

Enable block mode (922 mode only)
 Enable conversational mode

SET UP
DEFAULT = Conversational
 ESC [? 10 h
 ESC [? 10 l

When you are in set up, you can select from three modes of communication: local, block, and conversational. Programming commands can enable block or conversational, but not local.

Block mode lets the terminal display characters that you enter at the keyboard without sending them to the computer until the keyboard or the computer requests them. Then the characters are sent as a block. You can control when and how much data is transmitted (see the section on transmitting data). Any data received from the computer appears on the screen.

The 922 operates in full duplex conversational mode. The terminal transmits all key codes generated by the keyboard to the computer. Depending on the setting of local echo mode, the code may be treated as received data. The send/receive mode is by default set to no echo. With the local echo mode enabled, the codes are also sent to the terminal. The computer stores data it receives at a screen location or processes it.

Send/Receive Mode

No echo
 Echo

SET UP
DEFAULT = No echo
 ESC [12 h
 ESC [12 l

While conversational mode is enabled, you can control whether or not every character being transmitted to the computer is also echoed by the terminal back to its screen.

Sending Data

Send data (922 mode only)

ESC 5

With this command, the 922 reads data from the screen memory and sends it to the host computer. The 922 sends data from the home position up to and including the cursor position. At the beginning of each line, it sends the line attribute command; at the beginning of any character set, it sends the character set command.

PRINTING

The 922 printing functions operate in one of four modes which you select in set up: normal, auto line print, buffered, and bidirectional. You can also activate these print modes and additional print functions using the escape sequences shown in this section.

The default operation of normal print mode prints the entire screen. It is activated by pressing the Print Screen key. Normal print mode is disabled when you activate one of the other print modes.

When the terminal prints characters on the screen, it ignores terminal and printer tab stops and accepts space characters. In any print mode, the terminal transmits a carriage return and line feed, vertical tab, or form feed after the last printable character of a line that is not a space character. Extra space characters--those between the last printable character and the end of the line--are not sent to the printer unless they have visual attributes.

The computer recognizes double-height or double-width line attributes. When double-height lines are included, the terminal sends each half of the line to the printer twice.

You can check the printer status before selecting a print function by using the printer status report (see the Reports section of this chapter).

Print Extent

SET UP

DEFAULT = Full page

Send scrolling region to the printer

ESC [? 19 l

Send full page to the printer

ESC [? 19 h

These commands let you define how much of the screen is to be printed by the screen print command described in the next section. You can print either the entire screen or just the defined scrolling region. If you have not defined a scrolling region, you can only print the screen.

Screen Print

Print screen ESC [i

The screen print command lets you print the entire screen or just the defined scrolling region, depending on which you have designated in print extent.

Auto Line Print Mode

	DEFAULT = Disabled
Enable auto line print mode	ESC [? 5 i
Disable auto line print mode	ESC [? 4 i

When you enable auto line print mode, the terminal sends the contents of the current line to the printer after each carriage return, or when it receives a vertical tab, line feed or form feed character. With auto line print mode disabled, the terminal defaults to normal print mode.

Buffered Print Mode

	SET UP
	DEFAULT = Transparent
Enable buffered transparent print	ESC [5 i
Enable buffered copy print	ESC [? 7 i
Disable buffered print/enable normal print	ESC [4 i

The terminal's two buffers (main port and printer port) have a combined capacity of 512 characters. After you send data to the terminal's main port buffer, the buffered print mode sends it through the printer port buffer and out the printer port. The terminal can continue receiving data either from the keyboard or host while the printer output buffer empties. However, once both buffers are full, the terminal can receive no more. The terminal acts on the last print command it receives.

Buffered print modes let the baud rate between the computer and terminal differ from the baud rate between the terminal and its printer.

Transparent print sends data from the main port buffer directly to the printer port buffer without displaying it on the screen.

Copy print displays data on the screen as it goes to the printer port buffer.

After you disable the buffered print mode, any data remaining in the buffers is sent to the printer port until the printer output buffer is empty.

Bidirectional Print Mode (922 mode only)	SET UP
	DEFAULT = Transparent
Select bidirectional as copy	ESC [? 26 l
Select bidirectional as transparent	ESC [? 26 h
Enable bidirectional print mode	CTRL R
Disable bidirectional/enable normal print	CTRL T

You must select the type of print mode (either transparent or copy print) before you enable bidirectional print mode.

The computer and printer port baud rates must match.

After you select a print type (transparent or copy), the CTRL R command turns it on. CTRL T returns it to normal print mode.

While bidirectional print mode is enabled, the two RS-232C ports (P3 and P4) are connected (internally). Therefore, a peripheral device such as a printer connected to the P4 port can communicate through the terminal with the computer connected to the P3 port. Unless the printer has a keyboard, however, the printer can receive data only from the computer, while the computer can both send and receive data. Only the computer can write to the terminal screen.

Before you enable bidirectional print mode, you must select the type of bidirectional printing you want--either transparent or copy. (Copy print lets you print data and display it on the screen at the same time, while transparent print does not display data being printed.) Then enable bidirectional print mode.

NOTE! To use bidirectional print mode, the computer and printer must be set with the same communication format.

Print Cursor Line

Print the cursor line	ESC [? 1 i
-----------------------	-------------

This command lets you print out just the line in which the cursor is currently residing.

Screen Print Terminator	SET UP
	DEFAULT = No form feed
No form feed after screen print	ESC [? 18 l
Send form feed to printer after screen print	ESC [? 18 h

Use this command to determine whether the printer feeds a page up after printing.

REPROGRAMMING KEY CODES

The following commands will change the codes sent by some of the terminal's keys.

Cursor Key Mode	SET UP
	DEFAULT = Normal
Normal cursor key mode	ESC [? 1 l
Application cursor key mode	ESC [? 1 h

When you enable the application mode, the cursor keys generate control codes that are defined by your application program. Your program can then define the cursor key functions. In normal cursor key mode, the keys generate ANSI cursor key sequences instead. Table 5-6 shows the codes each cursor key can generate.

NOTE! See Appendix G for cursor key codes in VT52 mode.

Table 5-6
Cursor Key Codes

Key	Normal Mode	Application Mode
Cursor Up	ESC [A	ESC O A
Cursor Down	ESC [B	ESC O B
Cursor Right	ESC [C	ESC O C
Cursor Left	ESC [D	ESC O D

NOTE! When the terminal is in VT100 mode, the information in this section will also apply to function keys F11 through F14.

Keypad Mode	SET UP
	DEFAULT = Numeric
Enable numeric keypad mode	ESC >
Enable application keypad mode	ESC =

The numeric keypad can generate either numbers or control codes, depending on whether you designate numeric or application mode.

In numeric keypad mode, the keypad simply generates numbers. If you enable application keypad mode, the numeric keypad generates control codes. Table 5-7 shows the what each key generates during both numeric and application keypad modes.

**Table 5-7
Effect of Keypad Modes**

Key	Numeric Mode	Application Mode
00	00	ESC O o
0	0	ESC O p
1	1	ESC O q
2	2	ESC O r
3	3	ESC O s
4	4	ESC O t
5	5	ESC O u
6	6	ESC O v
7	7	ESC O w
8	8	ESC O x
9	9	ESC O y
-	-	ESC O m
'	'	ESC O l
ENTER	CTRL M	ESC O M

Line Feed/New Line

SET UP

DEFAULT = No new line

Enable line feed (disable new line)

ESC [20 l

Enable new line (disable line feed)

ESC [20 h

After you enable new line, pressing Return generates both a carriage return and a line feed code. When you send the terminal a line feed code from the computer, it performs both a carriage return and a line feed.

With line feed enabled, the Return key generates only a carriage return code. If you send the terminal a line feed code, it performs only a line feed.

The Function Keys

Your application program can program the function keys F6 through F14, Help, Do, and F17 through F20. In 922 mode, you can program the function keys in both their shifted and unshifted states. In VT220 mode, you can program the function keys in their shifted state only. The unshifted function keys send a nonprogrammable sequence your application program can control.

Function key information is stored in nonvolatile memory, so you do not lose the key's contents when you reset or turn off the terminal. Whenever you reprogram a function key, it loses its previous programming.

The function keys have a total of 256 bytes of memory available that can be allotted to any key or combination of keys. In 922 mode, 256 additional bytes are available for unshifted function keys. Unshifted and shifted function key memories cannot be combined. Any function key, whether in its shifted or unshifted states, can hold up to 255 bytes.

The default value of each programmable function key is no message (empty).

Programming the Function Keys

Program a function key

```
DEFAULT Pc/P1 = 0; Stn = 0
ESC P Pc ; P1 ; Ky1 / St1 ;
Ky2 / St2 ; ... ; Kyn / Stn
ESC \
```

Pc specifies whether or not all function keys will be cleared when you reprogram.

Pc	Effect
1	Clear old values only where new key values are being loaded.
0 or none	Clear all old values before loading new values.

If you choose Pc = 1, the old key values are locked except for each key as you load it. If the remaining total byte capacity of all the keys is less than the bytes required by the new data you are entering into that key, then your key loading sequence may fail because of insufficient space. This is because keys are cleared and loaded sequentially (in the order in which you list them in the command string). To avoid this problem, first load the key whose existing (old) data content is greatest.

P1 specifies whether or not key values are locked after you load them.

Value	Effect
1	Keys can be redefined.
0 or none	Keys are locked and cannot be redefined until you unlock them.

Kyn is a value for the function key you want to program. Table 5-8 lists, in both VT220 mode and 922 mode, function keys and the values that identify them.

Table 5-8
Kyn Values of Function Keys

Key	Shifted Value (VT200 and 922 Modes)	Unshifted Value (922 Mode Only)
F6	17	37
F7	18	38
F8	19	39
F9	20	40
F10	21	41
F11	23	43
F12	24	44
F13	25	45
F14	26	46
Help	28	48
Do	29	49
F17	31	51
F18	32	52
F19	33	53
F20	34	54

Stn is the data, expressed in hexadecimal values, to be transmitted by the function key identified by Kyn. See Appendix C for the hex code of each ASCII character. You can enter several definitions in one key by separating each value with a semicolon.

Constructing Programming Commands for the Function Keys

You can program a function key (for example, key F14, unshifted) to load STOP without clearing values in any other keys. The string would look like Figure 5-5.

Figure 5-5
Example of a Programmed Function Key

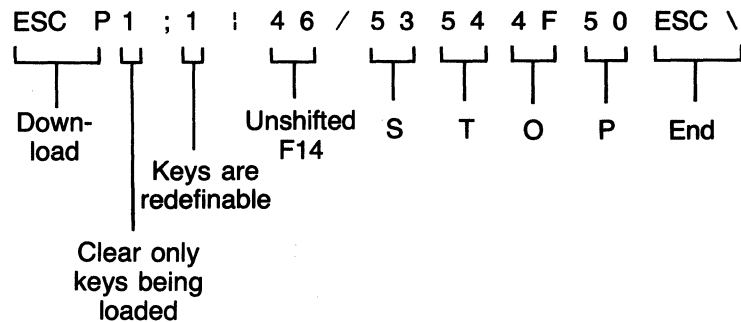

Here are some other examples. This string locks all the function keys:

```
ESC P 1 ; 0 | ESC \
```

This string clears all the function keys:

```
ESC P 0 ; 1 | ESC \
```

This string causes shifted F6 to perform two carriage returns and indent 5 spaces:

```
ESC P 1 ; 1 | 17 / 0D 0D 20 20 20 20 20 ESC \
```

TESTS, ADJUSTMENTS AND REPORTS

The terminal has tests, an alignment pattern and reports you can control from the keyboard or the host computer. Normally, these tests and reports are performed by manufacturing representatives or field service personnel rather than by users or programmers.

Terminal Tests

Run self test(s) ESC [4 Ps ; ... ; Ps y

Each Ps value represents a terminal test.

Ps	Test
0	Test 1, 2, 3, and 6
1	Power-up self test
2	EIA port data loopback test
3	Printer port loopback test
6	Modem control line loopback test
7	20 mA loopback test
9	Repeat selected tests

You can run several tests at one time by chaining the parameters together, separated by semicolons. The tests are not necessarily executed in the order in which you enter them.

Adjusting the Screen

Adjust the screen ESC # 8

This command fills the screen with upper case Es whose clarity you can watch while you adjust the monitor.

Programming the Status Indicators

Program status indicators

DEFAULT Ps = 0
ESC [Ps ; ... ; Ps q

Ps	Effect
0	Clear all indicators
1	Set indicator 1
2	Set indicator 2
3	Set indicator 3
4	Set indicator 4

The 922 terminal has four status indicators you can program to appear at the occurrence of specified events in your application program. Each number can represent any kind of event. The numbers appear in the eighth block of the status line when the program event occurs, and they can appear in any order. After all the events have occurred, the numbers turn off all at once, rather than individually.

These status indicators take the place of the light emitting diodes (LEDs) used by many terminals to indicate specific functions.

Cursor Position Report

Report cursor position

ESC [6 n

Your application program can ask the terminal to report the cursor's location. The terminal will reply with the sequence

ESC [Pl ; Pc R

where Pl is the decimal line number and Pc is the decimal column number.

Device Attribute Requests

Report primary device attributes

ESC [c

Report secondary device attributes

or ESC [0 c

ESC [> c

or ESC [> 0 c

The computer can request two device attribute (DA) reports from the 922, a primary and secondary DA report.

In the primary report, the host asks for the terminal's ID, which you can reprogram in set up. The terminal's default response is

```
ESC [ ? 62 ; 1 ; 2 ; 6 ; 7 ; 8 c
```

where

```
62 = Service class 2 terminal
1 = 132 columns
2 = Printer port
6 = Selective erase
7 = Soft-font character set
8 = User-defined keys
```

In the secondary report, the host asks for the terminal's identification code, firmware version level, and an account of the hardware options installed. The terminal responds

```
ESC [ > 1 ; Pv ; Po c
```

where

```
1 = Terminal identification (922) code
Pv = Firmware version
Po = Options installed
```

The operating system uses the device attribute report to recognize the terminal and determine whether it can communicate with the terminal. For example, a 922, firmware version A.0, no options, would respond

```
ESC [ > 1 ; 10 ; 0 c
```

Terminal Status Report

Request device status report

```
ESC [ 5 n
```

When the computer asks for the general operating status of the terminal and/or printer in a device status report, the terminal will indicate the current conditions of the its internal hardware with one of two reports:

```
ESC [ 0 n      Terminal is OK
or ESC [ 3 n      Terminal is not OK
```

If the terminal is in printer controller mode, the printer will receive the request but will not be able to answer.

Printer Port Status Report

Request printer port status report ESC [? 15 n

You should determine the printer status before entering any print mode or starting any print function. When you request a printer status report, the terminal will respond

ESC [? 10 n	Printer ready
or ESC [? 11 n	Printer not ready
or ESC [? 13 n	No printer

User Defined Keys

Request status of user defined keys ESC [? 25 n

The computer can ask whether the user defined keys are locked. When an application program needs to program function keys for specific uses, it cannot do so if you have locked the keys you defined. The terminal will respond

ESC [? 20 n	Unlocked
or ESC [? 21 n	Locked

Answerback Message

Transmit answerback message CTRL E

This command lets the terminal transmit an answerback message that will be displayed in the screen's 25th line. The terminal automatically transmits an answerback message after a disconnect.

6. TROUBLESHOOTING

INTRODUCTION

This chapter tells you how to check the 922 before you place a service call. It also shows you how to change the fuses and get help.

THE SELF TEST

Each time you turn on the 922, it runs a self test. The self test determines whether or not the 922 is running correctly by checking communication ports, memory, microprocessor CPUs, and internal hardware. If the 922 is running correctly, it will display this message on its screen:

922 OK

If the 922 displays something different (probably an error message), write it down and call your service center.

TROUBLESHOOTING PROCEDURES

If the 922 passes the self test but still fails to operate correctly, consult Table 6-1. Before placing a service call, look for a description of the problem and try the solution listed there.

Table 6-1
Troubleshooting Terminal Problems

Symptom	Possible Solution
Terminal dead (no beep; no cursor)	Unplug the power cord and plug in both ends again. Check and replace the line fuse. Turn on the power switch. Check the power select switch setting.
Terminal dead; cursor may appear	Unplug the power cord and change the line fuse.

Table 6-1
Continued

Symptom	Possible Solution
Terminal will not go on line	Make sure the system is "up." Reset the terminal. Make sure the terminal is not in block mode. Check the baud rate. Disconnect all cables and check for damage, then reattach the cables. Check the RS-232C (computer) port interface cables: Pins 1 and 7 must be grounded. Pin 2 must be connected to the computer receiver. Pin 3 must be connected to the computer transmitter. Pins 5, 6, and 8 must be driven by +12 volt dc power or be disconnected. Turn on the modem. Connect a different modem. Check the handset position in the modem cradle.
Cursor will not appear	Adjust the screen contrast.
Computer does not respond while on line	Set parity, word structure, and stop bits to match the computer's requirements.
No keyboard response	Unplug and reattach both ends of keyboard cable. STOP! This may reset the 922, which would clear the screen.
Terminal locked	Press Ctrl Reset. Review all set up parameters.

Table 6-1
Continued

Symptom	Possible Solution
Terminal prints correct data only part of the time or prints @ signs	Check the computer system's parity needs. Review stop bits and word structure in the set up screens.
Display is wavy or beep sounds unusual	Change hertz setting in set up.
Printer does not print what is typed	Check print mode and print command. Check baud rate, parity and word structure of the printer port. Check the printer cable's pin assignments: Pins 4 and 20 must be driven by +12 volt dc power or disconnected. Pin 3 must be connected to printer data input. Pin 2 must be connected to printer data output for operation with X-On/X-Off control. Check printer port parameters in set up.
Escape and control codes do not function as expected	Check escape sequences and control codes. Make sure upper- and lowercase letters are used as required. Is a one used instead of a lowercase L? Zero for uppercase O? Make sure the Lock key is not engaged. Is the terminal in control display mode: Disconnect the interface from the 922's computer port; connect the computer port's pins 2 and 3; try operating in full duplex. Try escape sequences with the Loc Esc key.

CHECKING THE FUSES

Power Supply Fuses

The power supply fuses are located inside the terminal. If you suspect one of the power supply fuses is defective, call your service technician.

STOP! Do not open and replace the fuses yourself. Opening the case exposes components that retain potentially hazardous voltages even after you turn off the power.

Line Fuse

To check the line fuse:

1. Turn off the power and unplug the 922's power cord (either from the terminal or from the wall outlet).
2. Remove the fuse holder by unscrewing it counterclockwise (Figure 6-1).
3. Slip the glass fuse out of the holder and examine it.

If the thin wire inside the fuse is intact (Figure 6-2), the fuse should be functional. If the thin strip is broken and/or the glass is slightly black (Figure 6-3), the fuse has blown and must be replaced. (A totally black fuse can indicate a problem with the power outlet. If that happens, call your service technician.)

4. Replace a blown fuse with a 1-ampere, fast-blow fuse for 110-volt applications or a 0.5-ampere, fast-blow fuse for 220-volt applications.

Figure 6-1
Location of the Line Fuse

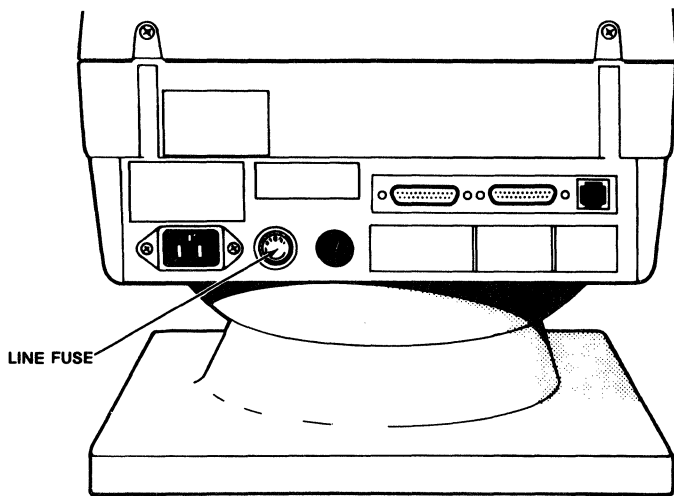

924 OM-5

Figure 6-2
Good Fuse

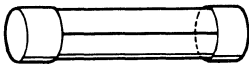
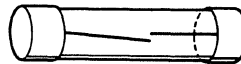

Figure 6-3
Burned-Out Fuse



924 OM-13

5. Replace and tighten the fuse holder.
6. Plug in the terminal power cord.

If the newly replaced fuse blows out immediately, do not replace it again. Call your service technician.

IF YOU NEED ASSISTANCE

TeleVideo has two service departments available to help you.

Call our Technical Assistance staff when you want to know how to use the terminal in a particular computer environment or need marketing information. You can call them between 8:30 a.m. and 5:00 p.m., Pacific time, Monday through Friday (except holidays).

Call our Customer Service group when you need help troubleshooting a hardware problem or want to return the terminal for repair. (Before you place a service call, refer to the Troubleshooting Guide in Table 6-1. Refer also to the index and find the section in the manual that covers the subject. Have the terminal and manual by the phone.) You can reach Customer Service between 7:00 a.m. and 5:00 p.m., Pacific time, Monday through Friday, except holidays.

Service Under Warranty

The terminal is covered by a limited warranty (see Appendix B). No warranty registration is required.

If you need service while the terminal is covered by the limited warranty, call our Customer Service Department (see previous section) for a Return Material Authorization number.

Reshipping the Terminal

Should you need to reship the terminal, ask your service technician to check the integrity of the cabling and the security of the internal mounting hardware.

Repack the terminal, using either the original TeleVideo shipping container or other suitable materials.

APPENDICES

- A Specifications**
- B Statement of Limited Warranty**
- C ASCII Code Equivalents**
- D Control Characters**
- E Set Up Mode Parameters**
- F ASCII, Supplemental, and Special Character Sets**
- G VT52 Mode Commands**

APPENDIX A SPECIFICATIONS

Physical

Part number	131245-00					
Dimensions	Height		Width		Depth	
	(in.)	(cm)	(in.)	(cm)	(in.)	(cm)
Cabinet	14.0	35.6	12.5	31.8	11.5	29.2
Keyboard	1.8	4.6	20.6	52.4	7.3	18.5
Weight	Shipping: Terminal, 30 pounds; keyboard, 5 pounds					
Screen	12 inches measured diagonally P31 green nonglare phosphor with time-out					
Terminal	Touch tilt (-5 to +20 degrees) Swivel (360 degrees)					

Display

Format	24 80- or 132-column lines 25th status line 8 set up screens
Character formation	6 x 7 dot matrix (standard) 8 x 10 cell Single or double width and height Descenders on alphanumeric characters
Character sets	Up to four working sets, selected from US ASCII, UK, special graphics, DEC supplemental, or downloadable custom font
Displayed characters	96 ASCII 81 supplemental multinational 32 special graphics 94 user-definable soft font
Cursor attributes	Blinking block, steady block, blinking underline, steady underline, not visible
Visual attributes	Character-by-character, nonembedded, combinable; blink, blank, underline, full/half intensity, and reverse video

Keyboard

Description	Detached, DIN standard low profile, sculptured keycaps with home key indicators, N-key rollover with ghost key lockout
Keypads	Typewriter-style alphanumeric Special-function and arrow keys Accounting-style numeric Function key row

Communications

Ports	Computer: 25-pin full duplex RS-232C and 10-pin 20 mA current loop Printer: 25-pin RS-232C and 9-pin DEC-compatible Composite video: BNC connector
Buffers	256-character computer and printer
Communication modes	Conversational, block, local
Print modes	Formatted page; buffered transparent/copy; auto line; bidirectional
Word structure	9-12 bits (7 or 8 data bits; 1 or 2 stop bits, parity or no parity)
Parity	Odd, even, mark, space, or none
Protocol	X-On/X-Off or Data Terminal Ready at either RS-232C port
Baud rates	10 for each port (75 to 19,200)

Functions

Cursor control	Home (relative to or independent of scrolling region), up, down, right, left, carriage return, line feed, tabs (forward and backward), save/restore position, address/read position
Editing	Character/line insert/delete, line/screen erase, selective character erase, smooth or normal scrolling with defined scrolling region, margin bell
Function keys	Up to 30 (15 unshifted and shifted); nonvolatile, programmable; 512 bytes combinable available memory

Operation

Operating modes	Terminal emulation, keypad character, cursor keys, control code display
Control codes	57 ASCII control characters Command sequences: ANSI and private Code structures: VT100, 7-bit VT220, 8-bit VT220, VT52, 922
Software compatibility	DEC VT52, VT100, VT220 ANSI X3.64 Tektronix Plot 10 (with graphics option)

Environmental Requirements

Power	115/230 volt ac, 50/60 Hz
Ventilation	4 inches minimum on all sides
Temperature	Operating: 32 degrees F (0 degrees C) to 122 degrees F (50 degrees C) Storage: -40 degrees F (-40 degrees C) to 149 degrees F (65 degrees C)
Relative humidity	Operating: 5%-95% noncondensing. Nonoperating: no restrictions.

Options

Option board	Dimensions: 7 in. x 8 in. Available power: 5V 1 amp (maximum) +12V 100 mA -12V 50 mA
Options	Graphics board and mouse European base plate British, Canadian (French), Danish, Dutch, Finnish, Flemish, French/Belgian, German, Italian, Norwegian, Spanish, Swedish, Swiss (French), Swiss (German) keyboards

APPENDIX B STATEMENT OF LIMITED WARRANTY

TeleVideo Systems, Inc. ("TeleVideo") warrants to its distributors, systems houses, and OEMs ("Buyer"), that products manufactured by TeleVideo are free from defects in materials and workmanship. TeleVideo's obligations under this warranty are limited to repairing or replacing, at TeleVideo's option, the part or parts of the products which prove defective in material or workmanship within 180 days after shipment by TeleVideo. Buyer may pass along to its initial customer or user ("Customer") a maximum of 90 days coverage within this 180-day warranty period, provided that Buyer gives TeleVideo prompt notice of any defect and satisfactory proof thereof.

Products may be returned by Buyer only after a Return Material Authorization number ("RMA") has been obtained from TeleVideo by telephone or in writing. Buyer will prepay all freight charges to return any products to the repair facility designated by TeleVideo and include the RMA number on the shipping container. TeleVideo will, at its option, either repair the defective products or parts or deliver replacements for defective products or parts on an exchange basis to Buyer, freight prepaid to the Buyer or the Customer. Products returned to TeleVideo under this warranty will become the property of TeleVideo. With respect to any product or part thereof not manufactured by TeleVideo, only the warranty, if any, given by the manufacturer thereof, applies.

Exclusions

This limited warranty does not cover losses or damage which occur in shipment to or from Buyer or Customer, or are due to, (1) improper installation or maintenance, misuse, neglect or any cause other than ordinary commercial or industrial application, or (2) adjustment, repair, or modifications by other than TeleVideo-authorized personnel, or (3) improper environment, excessive or inadequate heating or air conditioning and electrical power failures, surges, or other irregularities, or (4) any statements made about TeleVideo's products by salesmen, dealers, distributors or agents, unless confirmed in writing by a TeleVideo officer.

If the firmware or hardware is altered or modified by the Buyer or Customer, this firmware and hardware is not covered within this limited warranty and the Buyer or Customer bears sole responsibility and liability for that firmware and hardware.

THE FOREGOING TELEVIDEO LIMITED WARRANTY IS IN LIEU OF ALL OTHER WARRANTIES, WHETHER ORAL, WRITTEN, EXPRESSED, IMPLIED, OR STATUTORY. IMPLIED WARRANTIES OF MERCHANTABILITY AND FITNESS FOR A PARTICULAR PURPOSE DO NOT APPLY. TELEVIDEO'S WARRANTY OBLIGATIONS AND DISTRIBUTER'S REMEDIES HEREUNDER ARE SOLELY AND EXCLUSIVELY AS STATED HEREIN.

TELEVIDEO'S LIABILITY, WHETHER BASED ON CONTRACT, TORT, WARRANTY, STRICT LIABILITY, OR ANY OTHER THEORY, SHALL NOT EXCEED THE PRICE OF THE INDIVIDUAL UNIT WHOSE DEFECT OR DAMAGE IS THE BASIS OF THE CLAIM. IN NO EVENT SHALL TELEVIDEO BE LIABLE FOR ANY LOSS OF PROFITS, LOSS OF USE OF FACILITIES OR EQUIPMENT, OR OTHER INDIRECT, INCIDENTAL OR CONSEQUENTIAL DAMAGES.

APPENDIX C ASCII CODE TABLES

Table C-1
ASCII Code Chart

Bits	7 6 5 4 3 2 1				0 0 0	0 0 1	0 1 0	0 1 1	1 0 0	1 0 1	1 1 0	1 1 1
	4	3	2	1	0	1	2	3	4	5	6	7
	0	0	0	0	0	NUL	DLE	SP	@	P	~	p
	0	0	0	1	1	SOH	DC1	!	A	Q	a	q
	0	0	1	0	2	STX	DC2	"	B	R	b	r
	0	0	1	1	3	ETX	DC3	#	C	S	c	s
	0	1	0	0	4	EOT	DC4	\$	D	T	d	t
	0	1	0	1	5	ENQ	NAK	%	E	U	e	u
	0	1	1	0	6	ACK	SYN	&	F	V	f	v
	0	1	1	1	7	BEL	ETB	'	G	W	g	w
	1	0	0	0	8	BS←	CAN	(H	X	h	x
	1	0	0	1	9	SKIP HT	EM)	I	Y	i	y
	1	0	1	0	10 (a)	LF	SUB	*	J	Z	j	z
	1	0	1	1	11 (b)	VT↑	ESC	+	K	[k	{
	1	1	0	0	(c)	FF→	FS	,	L	\	l	
	1	1	0	1	13 (d)	CR	GS	-	M]	m	}
	1	1	1	0	14 (e)	SO	HOME RS	.	N	^	n	~
	1	1	1	1	15 (f)	SI	NEW LINE US	/	O	_	o	DEL RUB

Table C-2
ASCII Control Character Abbreviations

NUL	null	FF	form feed	CAN	cancel
SOH	start of heading	CR	carriage return	EM	end of medium
STX	start of text	SO	shift out	SUB	substitute
ETX	end of text	SI	shift in	ESC	escape
EOT	end of transmission	DLE	data link escape	FS	file separator
ENQ	enquiry	DC1	device control 1	GS	group separator
ACK	acknowledge	DC2	device control 2	RS	record separator
BEL	bell	DC3	device control 3	US	unit separator
BS	backspace	DC4	device control 4	SP	space
HT	horizontal tabulation	NAK	negative acknowledge	DEL	delete
LF	linefeed	SYN	synchronous idle		
VT	vertical tabulation	ETB	end of transmission block		

**Table C-3
ASCII Code Equivalents**

Supple- mental High	ASCII (Bit 7 Low)	Bit 7		Binary								Decimal (Bit 7 High Low)		Hex (Bit 7 High Low)	
		High	Low	6	5	4	3	2	1	0	High	Low	High	Low	
--	NUL	1	0	0	0	0	0	0	0	0	0	128	0	80	00
--	SOH	1	0	0	0	0	0	0	0	1	129	1	81	01	
--	STX	1	0	0	0	0	0	0	1	0	130	2	82	02	
--	ETX	1	0	0	0	0	0	0	1	1	131	3	83	03	
IND	EOT	1	0	0	0	0	0	1	0	0	132	4	84	04	
NEL	ENQ	1	0	0	0	0	0	1	0	1	133	5	85	05	
SSA	ACK	1	0	0	0	0	0	1	1	0	134	6	86	06	
ESA	BEL	1	0	0	0	0	0	1	1	1	135	7	87	07	
HTS	BS	1	0	0	0	0	1	0	0	0	136	8	88	08	
HTJ	HT	1	0	0	0	0	1	0	0	1	137	9	89	09	
VTS	LF	1	0	0	0	0	1	0	1	0	138	10	8A	0A	
PLD	VT	1	0	0	0	0	1	0	1	1	139	11	8B	0B	
PLU	FF	1	0	0	0	0	1	1	0	0	140	12	8C	0C	
RI	CR	1	0	0	0	0	1	1	0	1	141	13	8D	0D	
SS2	SO	1	0	0	0	0	1	1	1	0	142	14	8E	0E	
SS3	SI	1	0	0	0	0	1	1	1	1	143	15	8F	0F	
DCS	DLE	1	0	0	0	1	0	0	0	0	144	16	90	10	
PUL	D12	1	0	0	0	1	0	0	0	1	145	17	91	11	
PU2	DC2	1	0	0	0	1	0	0	1	0	146	18	92	12	
STS	DC3	1	0	0	0	1	0	0	1	1	147	19	93	13	
CCH	DC4	1	0	0	0	1	0	1	0	0	148	20	94	14	
MW	NAK	1	0	0	0	1	0	1	0	1	149	21	95	15	
SPA	SYN	1	0	0	0	1	0	1	1	0	150	22	96	16	
EPA	ETB	1	0	0	0	1	0	1	1	1	151	23	97	17	

Table C-3
Continued

Supple- mental High	ASCII (Bit 7 Low)	Bit 7		Binary								Decimal (Bit 7 High Low)		Hex (Bit 7 High Low)	
		High	Low	6	5	4	3	2	1	0	High	Low	High	Low	
--	CAN	1	0	0	0	1	1	0	0	0	152	24	98	18	
--	EM	1	0	0	0	1	1	0	0	1	153	25	99	19	
--	SUB	1	0	0	0	1	1	0	1	0	154	26	9A	1A	
CSI	ESC	1	0	0	0	1	1	0	1	1	155	27	9B	1B	
ST	FS	1	0	0	0	1	1	1	0	0	156	28	9C	1C	
OSC	GS	1	0	0	0	1	1	1	0	1	157	29	9D	1D	
PM	RS	1	0	0	0	1	1	1	1	0	158	30	9E	1E	
APC	US	1	0	0	0	1	1	1	1	1	159	31	9F	1F	
	SP	1	0	0	1	0	0	0	0	0	160	32	A0	20	
i	!	1	0	0	1	0	0	0	0	1	161	33	A1	21	
¢	"	1	0	0	1	0	0	0	1	0	162	34	A2	22	
£	#	1	0	0	1	0	0	0	1	1	163	35	A3	23	
--	\$	1	0	0	1	0	0	1	0	0	164	36	A4	24	
¥	%	1	0	0	1	0	0	1	0	1	165	37	A5	25	
--	&	1	0	0	1	0	0	1	1	0	166	38	A6	26	
§	' (apostrophe)	1	0	0	1	0	0	1	1	1	167	39	A7	27	
©	(1	0	0	1	0	1	0	0	0	168	40	A8	28	
©)	1	0	0	1	0	1	0	0	1	169	41	A9	29	
@	*	1	0	0	1	0	1	0	1	0	170	42	AA	2A	
«	+	1	0	0	1	0	1	0	1	1	171	43	AB	2B	
--	, (comma)	1	0	0	1	0	1	1	0	0	172	44	AC	2C	
--	- (hyphen)	1	0	0	1	0	1	1	0	1	173	45	AD	2D	
--	. (period)	1	0	0	1	0	1	1	1	0	174	46	AE	2E	
--	/	1	0	0	1	0	1	1	1	1	175	47	AF	2F	

Table C-3
Continued

Supple- mental High	ASCII (Bit 7 Low)		Binary								Decimal (Bit 7 High Low)		Hex (Bit 7 High Low)	
	High	Low	6	5	4	3	2	1	0	High	Low	High	Low	
°	0	1	0	0	1	1	0	0	0	0	176	48	B0	30
±	1	1	0	0	1	1	0	0	0	1	177	49	B1	31
²	2	1	0	0	1	1	0	0	1	0	178	50	B2	32
³	3	1	0	0	1	1	0	0	1	1	179	51	B3	33
--	4	1	0	0	1	1	0	1	0	0	180	52	B4	34
μ	5	1	0	0	1	1	0	1	0	1	181	53	B5	35
¶	6	1	0	0	1	1	0	1	1	0	182	54	B6	36
·	7	1	0	0	1	1	0	1	1	1	183	55	B7	37
--	8	1	0	0	1	1	1	0	0	0	184	56	B8	38
¹	9	1	0	0	1	1	1	0	0	1	185	57	B9	39
Ⓔ	:	1	0	0	1	1	1	0	1	0	186	58	BA	3A
»	;	1	0	0	1	1	1	0	1	1	187	59	BB	3B
¼	<	1	0	0	1	1	1	1	0	0	188	60	BC	3C
½	=	1	0	0	1	1	1	1	0	1	189	61	BD	3D
--	>	1	0	0	1	1	1	1	1	0	190	62	BE	3E
¿	?	1	0	0	1	1	1	1	1	1	191	63	BF	3F
À	@	1	0	1	0	0	0	0	0	0	192	64	C0	40
Á	A	1	0	1	0	0	0	0	0	1	193	65	C1	41
Â	B	1	0	1	0	0	0	0	1	0	194	66	C2	42
Ã	C	1	0	1	0	0	0	0	1	1	195	67	C3	43
Ä	D	1	0	1	0	0	0	1	0	0	196	68	C4	44
Å	E	1	0	1	0	0	0	1	0	1	197	69	C5	45
Æ	F	1	0	1	0	0	0	1	1	0	198	70	C6	46
Ç	G	1	0	1	0	0	0	1	1	1	199	71	C7	47

Table C-3
Continued

Supple- mental High	ASCII (Bit 7 Low)		Binary								Decimal (Bit 7 High Low)		Hex (Bit 7 High Low)		
	High	Low	Bit 7 High	Bit 7 Low	6	5	4	3	2	1	0	High	Low	High	Low
È	H		1	0	1	0	0	1	0	0	0	200	72	C8	48
É	I		1	0	1	0	0	1	0	0	1	201	73	C9	49
Ê	J		1	0	1	0	0	1	0	1	0	202	74	CA	4A
Ë	K		1	0	1	0	0	1	0	1	1	203	75	CB	4B
Ì	L		1	0	1	0	0	1	1	0	0	204	76	CC	4C
Í	M		1	0	1	0	0	1	1	0	1	205	77	CD	4D
Î	N		1	0	1	0	0	1	1	1	0	206	78	CE	4E
Ï	O		1	0	1	0	0	1	1	1	1	207	79	CF	4F
--	P		1	0	1	0	1	0	0	0	0	208	80	D0	50
Ñ	Q		1	0	1	0	1	0	0	0	1	209	81	D1	51
Ò	R		1	0	1	0	1	0	0	1	0	210	82	D2	52
Ó	S		1	0	1	0	1	0	0	1	1	211	83	D3	53
Ô	T		1	0	1	0	1	0	1	0	0	212	84	D4	54
Õ	U		1	0	1	0	1	0	1	0	1	213	85	D5	55
Ö	V		1	0	1	0	1	0	1	1	0	214	86	D6	56
Œ	W		1	0	1	0	1	0	1	1	1	215	87	D7	57
Ø	X		1	0	1	0	1	1	0	0	0	216	88	D8	58
Ù	Y		1	0	1	0	1	1	0	0	1	217	89	D9	59
Ú	Z		1	0	1	0	1	1	0	1	0	218	90	DA	5A
Û	[1	0	1	0	1	1	0	1	1	219	91	DB	5B
Ü	\		1	0	1	0	1	1	1	0	0	220	92	DC	5C
Ý]		1	0	1	0	1	1	1	0	1	221	93	DD	5D
--	^		1	0	1	0	1	1	1	1	0	222	94	DE	5E

**Table C-3
Continued**

Supple- mental ASCII (Bit 7 High	ASCII Low)	Bit 7		Binary							Decimal (Bit 7 High Low)		Hex (Bit 7 High Low)	
		High	Low	6	5	4	3	2	1	0	High	Low	High	Low
β	<u> </u>	1	0	1	0	1	1	1	1	1	223	95	DF	5F
à	`	1	0	1	1	0	0	0	0	0	224	96	E0	60
á	á	1	0	1	1	0	0	0	0	1	225	97	E1	61
â	b	1	0	1	1	0	0	0	1	0	226	98	E2	62
ã	c	1	0	1	1	0	0	0	1	1	227	99	E3	63
ä	d	1	0	1	1	0	0	1	0	0	228	100	E4	64
å	e	1	0	1	1	0	0	1	0	1	229	101	E5	65
æ	f	1	0	1	1	0	0	1	1	0	230	102	E6	66
ç	g	1	0	1	1	0	0	1	1	1	231	103	E7	67
è	h	1	0	1	1	0	1	0	0	0	232	104	E8	68
é	i	1	0	1	1	0	1	0	0	1	233	105	E9	69
ê	j	1	0	1	1	0	1	0	1	0	234	106	EA	6A
ë	k	1	0	1	1	0	1	0	1	1	235	107	EB	6B
ì	l	1	0	1	1	0	1	1	0	0	236	108	EC	6C
í	m	1	0	1	1	0	1	1	0	1	237	109	ED	6D
î	n	1	0	1	1	0	1	1	1	0	238	110	EE	6E
ï	o	1	0	1	1	0	1	1	1	1	239	111	EF	6F
--	p	1	0	1	1	1	0	0	0	0	240	112	F0	70
ñ	q	1	0	1	1	1	0	0	0	1	241	113	F1	71
ò	r	1	0	1	1	1	0	0	1	0	242	114	F2	72
ó	s	1	0	1	1	1	0	0	1	1	243	115	F3	73
ô	t	1	0	1	1	1	0	1	0	0	244	116	F4	74
õ	u	1	0	1	1	1	0	1	0	1	245	117	F5	75
ö	v	1	0	1	1	1	0	1	1	0	246	118	F6	76

Table C-3
Continued

Supple- mental ASCII (Bit 7 High Low)	Bit 7		Binary								Decimal (Bit 7 High Low)		Hex (Bit 7 High Low)	
	High	Low	6	5	4	3	2	1	0	High	Low	High	Low	
œ	w	1	0	1	1	1	0	1	1	1	247	119	F7	77
ø	x	1	0	1	1	1	1	0	0	0	248	120	F8	78
ù	y	1	0	1	1	1	1	0	0	1	249	121	F9	79
ú	z	1	0	1	1	1	1	0	1	0	250	122	FA	7A
û	{	1	0	1	1	1	1	0	1	1	251	123	FB	7B
ü		1	0	1	1	1	1	1	0	0	252	124	FC	7C
ÿ	}	1	0	1	1	1	1	1	0	1	253	125	FD	7D
--	~	1	0	1	1	1	1	1	1	0	254	126	FE	7E
	DEL	1	1	1	1	1	1	1	1	1	255	127	FF	7F

APPENDIX D CONTROL CHARACTERS

Table D-1
ASCII Control Characters

Control Code	ASCII Character	Hex Value	Character Displayed
CTRL @	NUL	00	NU
CTRL A	SOH	01	SH
CTRL B	STX	02	SX
CTRL C	ETX	03	EX
CTRL D	EOT	04	ET
CTRL E	ENQ	05	EQ
CTRL F	ACK	06	AK
CTRL G	BEL	07	BL
CTRL H	BS	08	BS
CTRL I	HT	09	HT
CTRL J	LF	0A	LF
CTRL K	VT	0B	VT
CTRL L	FF	0C	FF
CTRL M	CR	0D	CR
CTRL N	SO	0E	SO
CTRL O	SI	0F	SI
CTRL P	DLE	10	DL
CTRL Q	DC1	11	D1
CTRL R	DC2	12	D2
CTRL S	DC3	13	D3
CTRL T	DC4	14	D4
CTRL U	NAK	15	NK
CTRL V	SYN	16	SY
CTRL W	ETB	17	EB
CTRL X	CAN	18	CN
CTRL Y	EM	19	EM
CTRL Z	SUB	1A	?
CTRL [ESC	1B	EC
CTRL \	FS	1C	FS
CTRL]	GS	1D	GS
CTRL ^	RS	1E	RS
CTRL _	US	1F	US
DEL	DEL	7F	DT

**Table D-2
Supplemental Control Characters**

Escape Sequence	Supplemental Character	Hex Value	Character Displayed
ESC @	--	80	80
ESC A	--	81	81
ESC B	--	82	82
ESC C	--	83	83
ESC D	IND	84	84
ESC E	NEL	85	85
ESC F	SSA	86	86
ESC G	ESA	87	87
ESC H	HTS	88	88
ESC I	HTJ	89	89
ESC J	VTS	8A	8A
ESC K	PLD	8B	8B
ESC L	PLU	8C	8C
ESC M	RI	8D	8D
ESC N	SS2	8E	8E
ESC O	SS2	8F	8F
ESC P	DCS	90	90
ESC Q	PUL	91	91
ESC R	PU2	92	92
ESC S	STS	93	93
ESC T	CCH	94	94
ESC U	MW	95	95
ESC V	SPA	96	96
ESC W	EPA	97	97
ESC X	--	98	98
ESC Y	--	99	99
ESC Z	--	9A	9A
ESC [CSI	9B	9B
ESC \	ST	9C	9C
ESC]	OSC	9D	9D
ESC ^	PM	9E	9E
ESC _	APC	9F	9F
--	///	FF	☐

APPENDIX E SET UP MODE PARAMETERS

Parameter	Value Choices*	Screen/ Field Type**
Answerback=	Blank Selectable	Keyboard/T-P
Auto Answerback	Auto answerback No auto answerback	Keyboard/P
Auto Repeat	Auto repeat No auto repeat	Keyboard/P
Auto Wrap	Auto wrap No auto wrap	Display/P
Background	Normal Reverse	Display/P
Bits	7 8	Printer/P Comm/P
Bit Controls/VT100	7 bit 8 bit ASCII U.K.	General/P
Blinking/Steady	Blinking Steady	Display/P
Block/Underline	Block Underline	Display/P
Break	Break No break	Keyboard/P
Check	No check Check	Comm/P
Clear All Tabs	--	Tab/A
Clear Comm	--	Directory/A
Clear Display	--	Directory/A
Columns	80 132	Display/P
Comm	--	Directory/A

*Default values appear in bold print.
 **P = Parameter field; A = Action field; T-P = Text-parameter field.

Parameter	Value Choices*	Screen/ Field Type**
Concealed	Concealed Not concealed	Keyboard/P
Controls	Interpret Display	Display/P
Conv/Local/Block	Conversational Local Block	Directory/P
Cursor	Cursor No cursor	Display/P
Cursor Keys	Normal Application	General/P
Default	--	Directory/A
Disconnect	2s delay 60 ms delay	Comm/P
Display	--	Directory/A
Exit	--	Directory/A
General	--	Directory/A
Hertz	60 50	TVS922/P
Keyboard	--	Directory/A
Keyboard Language	British Canadian (French) Danish Dutch Finnish Flemish French/Belgian German Italian North American Norwegian Spanish Swedish Swiss (French) Swiss (German)	Directory/P

*Default values appear in bold print.

**P = Parameter field; A = Action field; T-P = Text-parameter field.

Parameter	Value Choices*	Screen/ Field Type**
Keyclick	Keyclick No keyclick	Keyboard/P
Keypad	Numeric Application	General/P
Keys	Typewriter Data processing	Keyboard/P
Local Echo	Local echo No local echo	Comm/P
Lock	Caps Shift	Keyboard/P
Margin Bell	Margin bell No margin bell	Keyboard/P
Mode	VT220 TVS922 VT52 VT100	General/P
New Line	New line No new line	General/P
Normal Intensity=	Half Full	TVS922/P
Parity	Even Odd Space Mark No	Comm/P Printer/P
Port	EIA port, data leads only EIA port, modem control 20 mA port	Comm/P
Print Full Page/ Scroll Region	Full page Scrolling region	Printer/P
Print Mode	Normal print Buffered Auto print Bidirectional	Printer/P

*Default values appear in bold print.
**P = Parameter field; A = Action field; T-P = Text-parameter field.

Parameter	Value Choices*	Screen/ Field Type**
Printed Data Type	ASCII/U.K. only ACSII/U.K. and line drawing All characters	Printer/P
Printer	--	Directory/A
Recall	--	Directory/A
Receive=	Transmit 75 110 150 300 600 1200 2400 4800 9600 19200	Comm/P
Reset Terminal	--	Directory/A
Save	--	Directory/A
Screen Saver=	Off 5 10 15 20 25 30 35 40 45 50 55 60	TVS922/P
Scroll	Smooth Jump	Display/P
Set 8 Column Tabs	--	Tab/A
Set Up =	English French German	Directory/P

*Default values appear in bold print.
**P = Parameter field; A = Action field; T-P = Text-parameter field.

Parameter	Value Choices*	Screen/ Field Type**
Speed=	75 110 150 300 600 1200 2400 4800 9600 19200	Printer/P
Status Line	Status line No status line	TVS922/P
Stop Bit	1 2	Comm/P Printer/P
Tab	--	Directory/A
Tab ruler	--	Tab/A
Terminal I.D. =	ESC[?62;1;2;6;7;8;c Selectable	TVS922/T-P
Terminator	No terminator =FF	Printer/P
To Directory	--	All screens but Directory/A
To Next Set-Up	--	All screens but Directory/A
Transmit	Limited Unlimited	Comm/P
Transmit Control	Transmit control No transmit control	TVS922/P

*Default values appear in bold print.

**P = Parameter field; A = Action field; T-P = Text-parameter field.

Parameter	Value Choices*	Screen/ Field Type**
Transmit=	75 110 150 300 600 1200 2400 4800 9600 19200	Comm/P
Transparent/ Copy Print	Transparent print Copy print	TVS922/P
TVS922	--	Directory/A
User Defined Keys	Unlocked Locked	General/P
User Features	Unlocked Locked	General/P
Warning Bell	Warning bell No warning bell	Keyboard/P
XOFF	64 128 None DTR	Comm/P

*Default values appear in bold print.
**P = Parameter field; A = Action field; T-P = Text-parameter field.

APPENDIX F ASCII, SUPPLEMENTAL AND SPECIAL CHARACTER SETS

Supple- mental (Bit 7 High)	ASCII (Bit 7 Low)	Special	Binary Code								
			Bit 7		6	5	4	3	2	1	0
			High	Low							
	SP	SP	1	0	0	1	0	0	0	0	0
¡	!	!	1	0	0	1	0	0	0	0	1
¢	"	"	1	0	0	1	0	0	0	1	0
£	#	#	1	0	0	1	0	0	0	1	1
--	\$	\$	1	0	0	1	0	0	1	0	0
¥	¥	¥	1	0	0	1	0	0	1	0	1
--	&	&	1	0	0	1	0	0	1	1	0
§	'	'	1	0	0	1	0	0	1	1	1
	((1	0	0	1	0	1	0	0	0
©))	1	0	0	1	0	1	0	0	1
	*	*	1	0	0	1	0	1	0	1	0
«	+	+	1	0	0	1	0	1	0	1	1
--	,	,	1	0	0	1	0	1	1	0	0
--	-	-	1	0	0	1	0	1	1	0	1
--	.	.	1	0	0	1	0	1	1	1	0
--	/	/	1	0	0	1	0	1	1	1	1
	0	0	1	0	0	1	1	0	0	0	0
±	1	1	1	0	0	1	1	0	0	0	1
²	2	2	1	0	0	1	1	0	0	1	0
³	3	3	1	0	0	1	1	0	0	1	1
--	4	4	1	0	0	1	1	0	1	0	0
µ	5	5	1	0	0	1	1	0	1	0	1
¶	6	6	1	0	0	1	1	0	1	1	0
·	7	7	1	0	0	1	1	0	1	1	1

Supple- mental (Bit 7 High)	ASCII (Bit 7 Low)	Special	Binary Code								
			Bit 7 High	Low	6	5	4	3	2	1	0
--	8	8	1	0	0	1	1	1	0	0	0
1	9	9	1	0	0	1	1	1	0	0	1
0	:	:	1	0	0	1	1	1	0	1	0
»	;	;	1	0	0	1	1	1	0	1	1
¼	<	<	1	0	0	1	1	1	1	0	0
½	=	=	1	0	0	1	1	1	1	0	1
--	>	>	1	0	0	1	1	1	1	1	0
¿	?	?	1	0	0	1	1	1	1	1	1
À	@	@	1	0	1	0	0	0	0	0	0
Á	A	A	1	0	1	0	0	0	0	0	1
Â	B	B	1	0	1	0	0	0	0	1	0
Ã	C	C	1	0	1	0	0	0	0	1	1
Ä	D	D	1	0	1	0	0	0	1	0	0
Å	E	E	1	0	1	0	0	0	1	0	1
Æ	F	F	1	0	1	0	0	0	1	1	0
Ç	G	G	1	0	1	0	0	0	1	1	1
È	H	H	1	0	1	0	0	1	0	0	0
É	I	I	1	0	1	0	0	1	0	0	1
Ê	J	J	1	0	1	0	0	1	0	1	0
Ë	K	K	1	0	1	0	0	1	0	1	1
Ì	L	L	1	0	1	0	0	1	1	0	0
Í	M	M	1	0	1	0	0	1	1	0	1
Î	N	N	1	0	1	0	0	1	1	1	0
Ï	O	O	1	0	1	0	0	1	1	1	1
--	P	P	1	0	1	0	1	0	0	0	0

Supple- mental (Bit 7 High)	ASCII (Bit 7 Low)	Special (Bit 7 Low)	Binary Code								
			Bit 7 High	Bit 7 Low	6	5	4	3	2	1	0
Ñ	Q	Q	1	0	1	0	1	0	0	0	1
Ò	R	R	1	0	1	0	1	0	0	1	0
Ó	S	S	1	0	1	0	1	0	0	1	1
Ô	T	T	1	0	1	0	1	0	1	0	0
Õ	U	U	1	0	1	0	1	0	1	0	1
Ö	V	V	1	0	1	0	1	0	1	1	0
Œ	W	W	1	0	1	0	1	0	1	1	1
Ø	X	X	1	0	1	0	1	1	0	0	0
Ù	Y	Y	1	0	1	0	1	1	0	0	1
Ú	Z	Z	1	0	1	0	1	1	0	1	0
Û	[[1	0	1	0	1	1	0	1	1
Ü	\	\	1	0	1	0	1	1	1	0	0
Ý]]	1	0	1	0	1	1	1	0	1
--	^	^	1	0	1	0	1	1	1	1	0
ß	—	(blank)	1	0	1	0	1	1	1	1	1
à	(underline)		1	0	1	1	0	0	0	0	0
á	(grave)	◊	1	0	1	1	0	0	0	0	1
â	a	∕	1	0	1	1	0	0	0	0	1
ã	b	Œ	1	0	1	1	0	0	0	1	0
ä	c	ƒ	1	0	1	1	0	0	0	1	1
å	d	¢	1	0	1	1	0	0	1	0	0
â	e	£	1	0	1	1	0	0	1	0	1
æ	f	•	1	0	1	1	0	0	1	1	0
ç	g	±	1	0	1	1	0	0	1	1	1
è	h	¤	1	0	1	1	0	1	0	0	0

Supple-
mental
(Bit 7
High)

	ASCII (Bit 7 Low)	Special	Binary Code								
			Bit 7 High	Low	6	5	4	3	2	1	0
é	i	∇	1	0	1	1	0	1	0	0	1
ê	j	┘	1	0	1	1	0	1	0	1	0
ë	k	┘	1	0	1	1	0	1	0	1	1
ì	l	┘	1	0	1	1	0	1	1	0	0
í	m	L	1	0	1	1	0	1	1	0	1
î	n	+	1	0	1	1	0	1	1	1	0
ï	o	-	1	0	1	1	0	1	1	1	1
--	p	-	1	0	1	1	1	0	0	0	0
ñ	q	-	1	0	1	1	1	0	0	0	1
ò	r	-	1	0	1	1	1	0	0	1	0
ó	s	-	1	0	1	1	1	0	0	1	1
ô	t	†	1	0	1	1	1	0	1	0	0
õ	u	†	1	0	1	1	1	0	1	0	1
ö	v	‡	1	0	1	1	1	0	1	1	0
œ	w	‡	1	0	1	1	1	0	1	1	1
ø	x	‡	1	0	1	1	1	1	0	0	0
ù	y	≤	1	0	1	1	1	1	0	0	1
ú	z	≥	1	0	1	1	1	1	0	1	0
û	{	π	1	0	1	1	1	1	0	1	1
ü		≠	1	0	1	1	1	1	1	0	0
ÿ	}	£	1	0	1	1	1	1	1	0	1
--	~	•	1	0	1	1	1	1	1	1	0
	DEL	DEL	1	1	1	1	1	1	1	1	1

APPENDIX G VT52 MODE COMMANDS

Sequence	Name	Effect
ESC A	Cursor up	Moves cursor up one line within current column position. Cursor cannot go back beyond top line of display.
ESC B	Cursor down	Moves cursor down one line within current column position. Cursor cannot go beyond bottom line.
ESC C	Cursor right	Moves cursor one position to right within current line. If autowrap is disabled, cursor cannot move beyond right margin. If autowrap is enabled, cursor wraps to next line.
ESC D	Cursor left	Moves cursor one position to left. Cursor cannot move beyond left margin.
ESC F	Enter graphics mode	Substitutes special graphics and character set for current ASCII character set. (Same as ANSI special graphics and character set.)
ESC G	Exit graphics mode	Return to current ASCII character set previously in use.
ESC H	Cursor home	Moves cursor to first position on first line of page.
ESC I	Reverse line feed	Moves cursor up one line within same column. If cursor is already on top line, display scrolls down.
ESC J	Erase to end of screen	Erases all characters from (and including) cursor position to (and including) end of display without moving cursor.
ESC K	Erase to end	Erases all characters from (and including) cursor position to end of current line without moving cursor.
ESC Y c l	Direct cursor address	Moves cursor to specified line (l) and column (c).
ESC Z	Identify terminal	Directs terminal to send an identifying escape sequence (ESC / Z) to computer.

Sequence	Name	Effect
ESC =	Enter application keypad mode	Causes keypad keys to send unique sequences in place of normal numeric values. See Table 5-7 for sequences sent in numeric and application keypad modes.
ESC >	Exit application keypad mode	Keypad keys send ASCII codes according to keycap labels.
ESC <	Return to previous terminal mode	Terminal returns to previous terminal emulation mode.

INDEX

- Addressing the cursor, 61
- Alternate keypad mode, 79
- ANSI
 - commands, 48
 - set/reset mode, 48
- Answerback message command, 86
- Assistance, 91
- Attributes
 - character, 55
 - line, 56, 69-71, 73, 77
 - visual, 55, 61, 68-69
- Auto answerback, 24
- Auto character repeat mode, 54
- Auto line print mode command, 77
- Auto print mode, 44
- Auto wrap, 17
- Autopage mode, 59-60, 62
- Autowrap mode, 59-60, 62, 68

- Back Space key, 31
- Back tab command, 62
- Back Tab key, 31
- Background of screen, 17
- Baud rate, 77-78
 - selection, 20
- Beep, 11, 87
- Bidirectional,
 - communication, 78
 - extension print, 78
 - print mode, 44
 - transparent print, 78
- Bit modes, 2
- Block mode, 15, 42-43, 75
- Break key, 31
- Brightness of screen, 14
- Buffers, 77
- Buffered print modes, 44, 77

- Cable requirements, 6
- Carriage return, 80
- CE key, 31

- Changing data, 35
 - Ctrl key, 32, 48
 - Current loop interface, 6
- Character
 - attributes, 55
 - insert, 68, 75
 - keys, 30
 - position, 55
 - sets, 61-65, A-21
- Characters
 - composing nonstandard, 36
 - size, 56
- Clear comm, 16
- Clearing tab stop, 62
- Column format, 17
- Columns per line, 56
- Commands
 - incorporating, 47
- Communication
 - bidirectional, 78
 - modes, 42-43, 75
- Compose Character key, 32, 36
- Compose
 - indicator, 36
 - mode, 36
 - sequence
 - three-stroke, 36
 - two-stroke, 37
- Computer, 6
 - busy, 45
 - port buffer, 77
 - status, 45
- Connectors
 - RJ-11, 4
- Control codes, 2, 79, 89
 - ASCII, 49
- Control modes, 42
- Conversational mode, 15, 42, 44, 75
- Copy print command, 78
- Creating nonstandard characters, 36

Ctrl Break key, 31
 Cursor
 absence of, 87-88
 appearance, 11
 attributes, 54
 back tab, 62
 down, 59-60
 field, 14
 forward, 59
 home, 61
 horizontal tabulation
 command, 62
 key mode, 79
 keys, 32
 left command, 60
 line/column addressing, 61
 movement, 59-60, 74
 next line command, 60
 position, 45
 report, 84
 saving, 61
 previous line command, 60
 right command, 59
 restoring, 61
 saving description, 61
 style, 17
 tab movement of, 62
 up
 command, 59
 movement, 60
 Customer Service department, 91
 Damage from shipping, 3
 Data
 changing, 35
 communication, 42-43
 compression, 75
 entry, 77
 erasing, 35
 flow, 43
 loss of, 56, 69, 73
 transmission, 2, 45, 75-76
 Data Terminal Ready (DTR)
 control, 77
 DCE interface connector
 assignments, 9
 Define scrolling region command, 72
 Defined scrolling region, 56,
 59-61, 69, 72-74
 printing, 76
 Delete character command, 68
 Delete Key, 32
 Delete line command, 69
 Deleting data, 35
 Delimiters
 double-height line, 77
 Designate characters command,
 64-65
 Device attribute request, 84
 Device status report, 85
 Diacritical mark, 37
 Directory screen, 15
 Disable autowrap command, 60
 Display
 background, 17
 intensity, 55
 turning off, 58
 screen, 16
 wavy, 89
 Distance of terminal to computer
 or modem, 6
 Do key, 32
 Double-height lines, 57
 printing, 77
 Double-width line, 57
 Downloading data, 45
 DTE interface connector
 assignments, 8
 Duplex mode, 75, 88

 Echo/no echo, 75
 Edit,
 boundary mode, 71
 control, 45
 extent mode, 68
 Editing, 35
 Enable autowrap command, 60
 ENTER key, 32
 Erase commands, 70-72
 Erasing data, 35
 Esc key, 32, 47, 48
 Escape sequences, 89
 European base plate, 6

 Field cursor, 14
 Fields in set up, 14
 Find key, 33
 Flow control, 20, 26
 Form feed command, 78
 Full duplex mode, 75, 88
 Function keys, 4, 33
 default values, 81
 programming, 80
 Fuse
 line, 90
 neutral, 6
 power supply, 90

 Graphics Option, 1

Half duplex mode, 75
Health hazard from X-ray
emissions, 3
Help key, 33
Hertz, 26
 setting, 5, 89
Hold Screen key, 33
Home position, 61
Horizontal editing mode, 68
Horizontal tabulation command,
62

Index commands, 60
Insert character, 68-69, 75
Insert Here key, 33
Insert line command, 69
Insert mode, 68
Inspection, 3
 line fuse, 90
Installation, 2-4
 summary, 12
Intensity of screen, 55
Interface cables, 6-7

Jump scroll, 17, 73

Key

Back Space, 31
Back Tab, 31
Break, 31
CE, 31
Comp Char, 36
Compose Character, 32
Ctrl, 32, 48
Ctrl Break, 31
Cursor Down, 32
Cursor Left, 32
Cursor Right, 32
Cursor Up, 32
Delete, 32
Do, 32
Enter, 32
Esc, 32, 47, 48
F11, 33
F12, 33
F13, 33
F14, 33
F17-F20, 33
F4, 33
F6-F10, 33
Find, 33
Help, 33
Hold Screen, 33
Insert Here, 33
Line Feed, 33

Key

Loc Esc, 33, 47
Lock, 34, 89
Next Screen, 34
PF1-PF4, 34
Prev Screen, 34
Print Screen, 34, 44
Remove, 34
Return, 34, 80
Select, 34
Send, 34, 44
Set Up, 34
Shift, 35
shifted Break, 31
shifted F6-F10, 33
shifted Tab, 35
Tab, 35

Keyboard, 29
 auto repeat mode, 23
 cable, 88
 character keys, 30
 connecting, 4
 keyclick, 53
 keyclick mode, 24
 lack of response, 88
 lock/unlock, 45, 53, 88
 modes of operation, 30
 set up screen, 23
 special keys, 30
Keyclick command, 53
Keypad modes, 79
Keys
 function, 4, 33, 80-81
 user defined, 18, 86

Legend label, 4

Limited warranty, 91, A-5

Line

 attributes, 56, 69-71, 73, 77
 feed/new line, 80
 numbers, 74
 delete command, 69
 double-height, 57
 double-width, 57
 selective erase, 70
 single-width, 56
Line Feed key, 33
Load soft font characters
 command, 66
Loc Esc key, 33, 47
Local edit mode, 47
Local mode, 15, 42, 44
Lock key, 34, 89
Lock/unlock keyboard, 45, 53, 88
Locking shifts, 67

Main, see Computer
 Manual organization, 2
 Memory, 13
 locked area, 73
 Mode
 alternate keypad, 79
 ANSI set/reset, 48
 auto character repeat, 54
 auto print, 44
 autopage, 59-60, 62
 autowrap, 59, 60, 62, 68
 bidirectional print, 44, 78
 block, 15, 42-43, 75
 buffered print, 44, 77
 communication, 42-43, 75
 conversational, 15, 42, 44, 75
 cursor key, 79
 edit boundary, 71
 edit extent, 68
 horizontal editing, 68
 insert, 68
 keypad, 79
 line feed, 80
 local, 15, 42, 44
 local edit, 47
 native, 56
 new line, 80
 normal print, 44, 76
 numeric keypad, 79
 operating, 56
 origin, 61, 73-74
 private set/reset, 49
 protect, 60, 62
 relative origin, 73
 replace, 68
 scrolling, 73
 send/receive, 75
 text cursor, 54
 vertical editing, 69
 VT100, 56, 71

 Native mode, 56
 New line mode, 80
 Next Screen key, 34
 Nonerasable characters, 72
 Nonspacing diacritical mark, 37
 Normal print mode, 44, 76
 Notices, 2
 Numeric keypad mode, 79

 Operating modes, 56
 Operating parameters, 2, 13
 Operation,
 7- and 8-bit, 2
 Origin mode, 61, 73, 74

 Parity, 88, 89
 PF1-PF4 keys, 34
 Pin connector assignments, 9
 Ports
 see Computer and Printer, 6
 Power
 blocking strip, 6
 configuration, 5
 on, 79
 requirements, 5
 select switch, 5
 Prev Screen key, 34
 Previous line command, 60
 Print
 buffered, 77
 cursor line command, 78
 extent, 76
 modes, 22
 Print screen command, 77
 Print Screen key, 34, 44, 76
 Printer
 busy, 45
 configuration, 89
 connecting, 9
 output buffer, 77
 port, 6, 78
 status report, 86
 screen, 21
 status, 45
 Printing, 44, 76, 89
 defined scrolling region, 76
 incorrect, 89
 Private set/reset mode, 49
 Programming
 features, 2
 function keys, 80
 the terminal, 47, 52
 Protecting selected text, 72

 Recall, 16
 Relative origin mode, 73
 Remove key, 34
 Replace mode, 68
 Reset key, 34

Resetting the terminal, 16, 52, 79
 Reshipping, 91
 Restoring the cursor, 61
 Return key, 34, 80
 Return Material Authorization (RMA), A-5
 Reverse index command, 60
 RJ-11 connector, 4
 RS-232C
 cabling, 7
 computer port pin compatibility, 7
 interface, 6
 interface installation, 7
 pin connector assignments, 7
 printer port pin compatibility, 9
 printer ports, 9
 ports, 78
 Run self test command, 83

 Save, 16
 Saving character set, 61
 Saving cursor description, 61
 Saving the cursor position, 61
 Screen
 adjusting, 83
 background, 57
 brightness control, 14
 brightness command, 58
 display, 16
 erase, 71
 intensity, 26, 55
 print commands, 76
 saver, 26, 58
 set up, 13
 updating, 77, 78
 Scrolling, 17, 73
 defined region, 61, 69, 72-74
 Select key, 34
 Selective erase in line, 70
 Send data command, 76
 Send key, 34, 44
 Send/receive mode, 75

 Serial printer, 9
 Service calls, 87
 Set character attribute command, 72
 Set up, 13, 88
 clear display, 16
 Communications screen, 19-21
 Directory screen, 15-16
 Display screen, 16-17
 feature, 13
 fields, 14
 General screen, 18-19
 Keyboard screen, 23-24
 mode
 entering, 14
 leaving, 27
 saving values, 27
 screen brightness, 14
 Printer screen, 21-23
 screens, 13-14
 Tab screen, 24-25
 TVS922 screen, 25-27
 Set Up key, 34
 Setting tab stop, 62
 Seven- and eight-bit operation, 2, 18, 20, 42
 Shift key, 35
 Shifted Break key, 31
 Shifted F6-F10 keys, 33
 Shifted Tab key, 35
 Single shifts, 67
 Single-width line, 56
 Site requirements, 3
 Smooth scroll, 17, 73
 Soft reset, 52
 Special keys, 30
 Status indicators, 45, 84
 Status line, 13, 26, 45
 Stop bits, 22, 88-89
 System response, 88

 Tabs, 62
 Tab key, 35
 Tab screen, 24
 Technical assistance, 91

Terminal
 adjusting tilt, 11
 beep, 11
 buffers, 77
 busy, 45
 controlling from keyboard, 47
 controls, 47
 dead, 87
 defining operation, 13
 device status report, 85
 grounding, 10
 height, 3
 I.D., 27
 installing, 4
 main receive buffer, 77
 modes, 50
 on-line, 88
 plugging in, 10
 power requirements, 5
 printer output buffer, 77
 programming, 47
 resetting, 79
 reshipping, 91
 self test, 87
 set up, 13
 seven- and eight-bit
 operation, 2, 18, 20, 42
 site selection, 3
 specifications, A-2
 status, 45
 tests, 83
 turning on, 10

 Text cursor mode, 54
 Transmit condition, 45
 Transparent print command, 78
 Troubleshooting, 2, 87

 Unlock keyboard command, 53
 User's message line, 56

 Vertical scrolling, 73
 Visual attributes, 55, 61, 68-69
 VT100 mode, 56, 71

 Warranty, see Limited warranty
 Word structure, 88, 89

 X-On/X-Off, 20, 26, 77, 89
 X-ray emissions, 3

QUICK REFERENCE GUIDE

ANSI COMMANDS

ANSI set mode ESC [Ps ; ... ; Ps h
ANSI reset mode ESC [Ps ; ... ; Ps l

Ps	Name
0	Error (ignored)
2	Keyboard action
4	Insertion-replacement
12	Send-receive
20	Line feed/new line

Private set mode ESC [? Ps ; ... ; Ps h
Private reset mode ESC [? Ps ; ... ; Ps l

Ps	Name
0	Error (ignored)
1	Cursor key
2	ANSI/VT52
3	Column
4	Scroll
5	Screen background
6	Origin
7	Autowrap
8	Auto repeat
10	Block/conversation
18	Printer form feed
19	Printer extent
22	Keyclick
23	Screen off/on
25	Text cursor enable
26	Print mode copy/transparent
27	Intensity full/half
30	Set up enabled/disabled (922 mode only)

RESETTING VALUES

Set up mode unlocked ESC [? 30 l
Set up mode locked ESC [? 30 h
Save set up values CTRL S
Reset to power-on state ESC c
Return to factory default values ESC [2 y
Soft reset ESC [! p

TERMINAL MODES

Set native (922 ANSI) mode (8 bit)	ESC [6 3 " p
	or ESC [6 3 ; 0 " p
	or ESC [6 3 ; 2 " p
Set native (922 ANSI) mode (7 bit)	ESC [6 3 ; 1 " p
Set VT220 mode (8 bit)	ESC [6 2 " p
	or ESC [6 2 ; 0 " p
	or ESC [6 2 ; 2 " p
Set VT220 mode (7 bit)	ESC [6 2 : 1 " p
Set VT100 mode*	ESC [6 1 " p
Set VT52 mode*	ESC [? 2 1
Return to previous mode from VT52 mode	ESC <
Set the terminal to receive 7-bit control codes	ESC <space> F
Set the terminal to receive 8-bit control codes	ESC <space> G

KEYBOARD ACTION

Unlock the keyboard	ESC [2 1
Lock the keyboard	ESC [2 h
Keyclick on	ESC [? 22 1
Keyclick off	ESC [? 22 h
Auto character repeat on	ESC [? 8 h
Auto character repeat off	ESC [? 8 1

CONTROLLING THE DISPLAY

Determine 25th line visibility	ESC [0 ; Ps z
--------------------------------	----------------

Ps Effect

0	25th line blank
1	25th line displays the status line

Define one cursor attribute	ESC [3 ; Ps z
-----------------------------	----------------

Ps Effect

0	Blinking block
1	Steady block
2	Blinking underline
3	Steady underline
4	No cursor

Text cursor visible	ESC [? 25 h
Text cursor invisible	ESC [? 25 l
Full intensity	ESC [? 27 h
Half intensity	ESC [? 27 l

CONTROLLING THE DISPLAY Continued

Define character attribute of display ESC [Ps m
Define character attributes of display ESC [Ps ; ... ; Ps m

Ps	Effect
0	Normal video (either increased or decreased intensity)
1	Increased intensity
2	Decreased intensity
3	Blank (invisible)
4	Underline
5	Blink
7	Reverse video
22	Normal video
23	Visible
24	Not underlined
25	Not blinking
27	Normal image (light characters, dark screen)

Select single-width line	ESC # 5
Select double-width line	ESC # 6
Select top half of double-height/double width line	ESC # 3
Select lower half of double-height/double width line	ESC # 4
80 columns	ESC [? 3 l
132 columns	ESC [? 3 h
Dark background	ESC [? 5 l
Light background	ESC [? 5 h
Set screen brightness	ESC [4 ; Ps z

Ps	Effect
0	Maximum brightness
1	Minimum brightness
~	
30	Maximum brightness

Select screen saver time ESC [2 ; Ps z

Ps	Effect	Elapsed Time in Minutes Between Data Entry
0	Disabled	0
1	Enabled	5
2	Enabled	10
3	Enabled	15
~		
12	Enabled	60

CONTROLLING THE CURSOR

Move the cursor up	ESC [Pn A
Move the cursor down	ESC [Pn B
Move the cursor right	ESC [Pn C
Move the cursor left	ESC [Pn D
Move the cursor to the next line	ESC [Pn E (922 mode only)
	or ESC E
Move the cursor to the previous line	ESC [Pn F
Index	ESC D
Reverse index	ESC M
Disable autowrap mode (no wrap)	ESC [? 7 l
Enable autowrap mode (wrap)	ESC [? 7 h
Save the cursor description	ESC 7
Restore the cursor description	ESC 8
Address the cursor to line and column	ESC [Pl ; Pc H
	or ESC [Pl ; Pc f
Move the cursor to home position	ESC [H
	or ESC [f

TABS

Set tab stop(s)	ESC H
Clear tab stop(s)	ESC [Ps g

Ps Effect

0	Clears the tab stop at the current cursor position
3	Clears all tab stops

Tab forward	CTRL I
	or ESC [Pn I (922 only)
Tab backward	ESC [Pn Z

CHARACTER SETS

Designate standard ASCII characters	ESC Ps B
Designate supplemental characters	ESC Ps <
Designate U.K. characters	ESC Ps A
Designate special characters	ESC Ps 0
Designate down-line loadable characters	ESC Ps Dscs

Ps Designation

(G0
)	G1
*	G2
+	G3

Load soft font characters	ESC P Pfn ; Pcn ; Pe ; Pcms ; Pw ; Pt { Dscs sss/sss ; ESC \
---------------------------	--

CHARACTER SETS Continued

Invoke G0 into GL, lock shift	CTRL O
Invoke G1 into GL, lock shift	CTRL N
Invoke G1 into GR, lock shift	ESC ~
Invoke G2 into GL, lock shift	ESC n
Invoke G2 into GR, lock shift	ESC }
Invoke G3 into GL, lock shift	ESC o
Invoke G3 into GR, lock shift	ESC :
Invoke G2 into GL, single shift	ESC N
Invoke G3 into GL, single shift	ESC O

EDITING

Enable replace mode	ESC [4 l
Enable insert mode	ESC [4 h
Insert space character(s)	ESC [Pn @
Delete character(s)	ESC [Pn P
Insert line	ESC [Pn L
Delete line(s)	ESC [Pn M
Erase character(s)	ESC [Pn X
Erase the current line	ESC [Ps K

Ps Effect

- 0 Erase from the cursor to the end of the current line, including the cursor position. Cursor line attributes remain.
- 1 Erase from the beginning of the current line up to and including the cursor.
- 2 Erase the entire current line.

Erase within the current line ESC [? Ps K

Ps Effect

- 0 Erase from the cursor to the end of the current line.
- 1 Erase from the the beginning of the current line up to and including the cursor.
- 2 Erase the entire current line.

Erase the screen ESC [Ps J

Ps Effect

- 0 Erase from, and including, the cursor position to the end of the screen.
- 1 Erase from the beginning of the screen up to and including the cursor position.
- 2 Erase the entire screen, change all lines to the single-width attribute. The cursor does not move.

EDITING Continued

Erase within the screen

ESC [? Ps J

Ps Effect

- 0 Erase all erasable characters from, and including, the cursor to the end of the screen.
- 1 Erase all erasable characters from the beginning of the screen up to and including the cursor position.
- 2 Erase the entire screen. Line and character attributes are not affected.

Set character erase attribute

ESC [Ps " q

Ps Effect

- 0 or 1 Defines nonerasable characters.
- 2 Defines erasable characters.

Erase within field

ESC [Ps N

Ps Effect

- 0 Erase from the cursor position to, but not including, the next tab stop or through the end of the field.
- 1 Erase from the start of the tab field through the cursor position and move the cursor to the beginning of the tab field.
- 2 Erase the entire tab field and reposition the cursor at the current tab stop or at the beginning of the line.

Define the scrolling region

ESC [Pt ; Pb r

Define scrolling mode as jump

ESC [? 4 l

Define scrolling mode as smooth

ESC [? 4 h

Enable relative origin mode (dependent)

ESC [? 6 h

Enable absolute origin mode (independent)

ESC [? 6 l

CONTROLLING COMMUNICATION

Enable block mode (922 mode only)

ESC [? 10 h

Enable conversational mode

ESC [? 10 l

No echo

ESC [12 h

Echo

ESC [12 l

Send data (922 mode only)

ESC 5

PRINTING

Send scrolling region to the printer	ESC [? 19 l
Send full page to the printer	ESC [? 19 h
Print screen	ESC [i
Enable auto line print mode	ESC [? 5 i
Disable auto line print mode	ESC [? 4 i
Enable buffered transparent print	ESC [5 i
Enable buffered copy print	ESC [? 7 i
Disable buffered print/enable normal print	ESC [4 i
Select bidirectional as copy	ESC [? 26 l
Select bidirectional as transparent	ESC [? 26 h
Enable bidirectional print mode	CTRL R
Disable bidirectional/enable normal print	CTRL T
Print the cursor line	ESC [? 1 i
No form feed after screen print	ESC [? 18 l
Send form feed to printer after screen print	ESC [? 18 h

REPROGRAMMING KEY CODES

Normal cursor key mode	ESC [? 1 l
Application cursor key mode	ESC [? 1 h
Enable numeric keypad mode	ESC >
Enable application keypad mode	ESC =
Enable line feed (disable new line)	ESC [20 l
Enable new line (disable line feed)	ESC [20 h
Program a function key	ESC P Pc ; Pl ; Ky1 / St1 ; Ky2 / St2 ; ... ; Kyn / Stn ESC \

TESTS, ADJUSTMENTS AND REPORTS

Run self test(s)

ESC [4 Ps ; ... ; Ps y

Ps	Test
0	Test 1, 2, 3, and 6
1	Power-up self test
2	EIA port data loopback test
3	Printer port loopback test
6	Modem control line loopback test
7	20 mA loopback test
9	Repeat selected tests

Adjust the screen

ESC # 8

Program status indicators

ESC [Ps ; ... ; Ps q

Ps	Effect
0	Clear all indicators
1	Set indicator 1
2	Set indicator 2
3	Set indicator 3
4	Set indicator 4

Report cursor position

ESC [6 n

Report primary device attributes

ESC [c

or ESC [0 c

Report secondary device attributes

ESC [> c

or ESC [> 0 c

Request device status report

ESC [5 n

Request printer port status report

ESC [? 15 n

Request status of user defined keys

ESC [? 25 n

Transmit answerback message

CTRL E







 **TeleVideo Systems, Inc.**

1170 Morse Avenue
Sunnyvale, CA 94086