

Tandon

TM848-1E, TM848-2E

FLEXIBLE DISK DRIVES

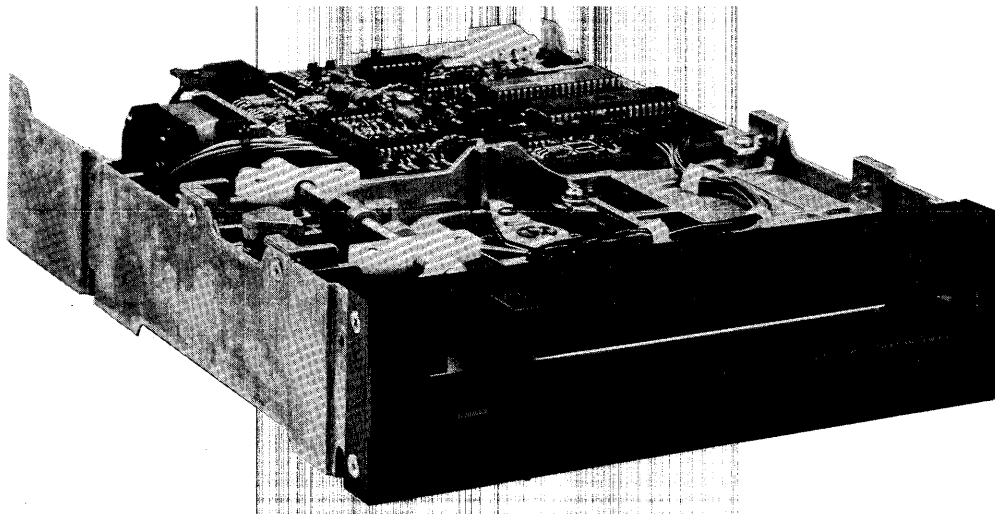

PRODUCT SPECIFICATION AND USER'S MANUAL

NOTICE

This document, and the information contained herein, is copyright by Tandon Corporation and may not be duplicated or reproduced, in whole or in part, without the prior written approval of Tandon Corporation.

This document is intended to provide the user with detailed information adequate for the efficient installation, operation, and service of the equipment involved.

However, while every effort has been made to keep the information contained herein current and accurate as of the date of publication, no guarantee is given or implied as to its accuracy.

TM848-1E, TM848-2E
THINLINE™ FLEXIBLE DISK DRIVE
48 TRACKS PER INCH
PRODUCT SPECIFICATION AND USER'S MANUAL

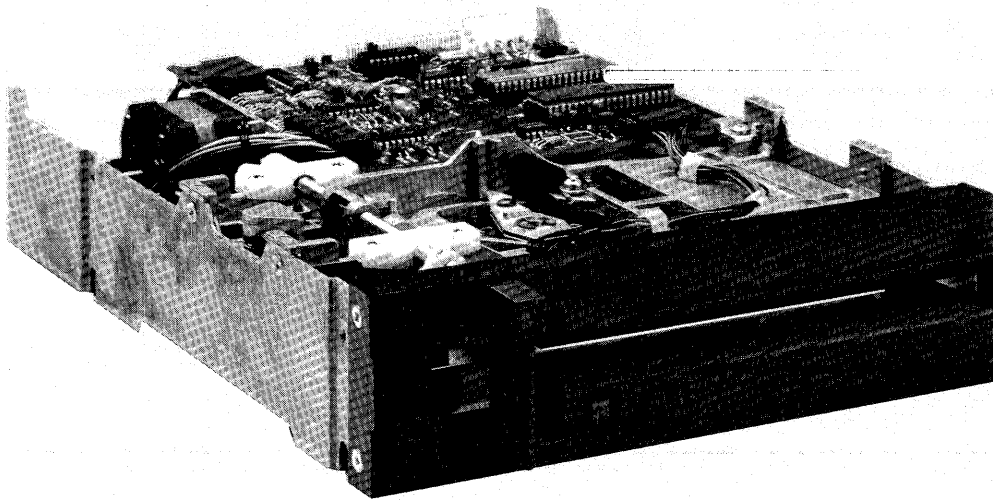

Tandon CORPORATION
20320 PRAIRIE STREET
CHATSWORTH, CALIFORNIA 91311

© COPYRIGHT 1983 TANDON CORPORATION

CONTENTS

Section Number	Title	Page Number
SECTION 1	GENERAL DESCRIPTION	
	Introduction	1-1
1.1	Scope Of The Document	1-1
1.2	Purpose Of The Drive	1-1
1.3	Major Features	1-1
	Microprocessor Control	1-1
	Write Protect	1-1
	Daisy Chain Capability	1-1
	Internal Trim Erase	1-2
	Industry Standard Interface Compatibility	1-2
	Activity Indicator	1-2
	Direct Drive, Brushless D. C. Motor	1-2
	Compact Size	1-2
	Diskette Lever Lock Solenoid	1-2
1.4	Functional Description	1-2
	Power On Self-Tests	1-3
1.5	Physical Description	1-3
SECTION 2	PRODUCT SPECIFICATIONS	
	Introduction	2-1
2.1	Mechanical Specifications	2-1
2.2	Electrical and Operational Specifications	2-1
2.3	Reliability Specifications	2-1
2.4	Environmental Specifications	2-1
SECTION 3	OPERATION	
	Introduction	3-1
3.1	Unpacking The Drive	3-1
3.2	Preinstallation Checkout	3-1
3.3	Mounting The Drive	3-1
	Dust Cover	3-2
	Cooling	3-2
3.4	Interface Connections	3-2
	Input Control Lines	3-2
	Output Control Lines	3-5
	Typical Interface Characteristics	3-6
3.5	D. C. Power	3-6
3.6	Drive Address and Option Strapping	3-8
	Drive Select (DS1—DS4)	3-8
	Head Select Options (S1—S3 and 1B—4B)	3-8
	Stepper Motor Power (PS, PS*, DS, HL)	3-10
	Spindle Motor Control Options (M1, M3, M4, MOL, MOH, MC1—MC4)	3-10
	Ready and True Ready (R and TR)	3-13
	Lever Lock Options (D, DL, LL, NL)	3-13
	Disk Change (DC)	3-13
	Two-Sided Diskette Installed (2S)	3-13
	Write Protect (WP and NP)	3-13
	Write Current Switch (XC and IC)	3-14
	Diagnostic Mode of Operation (DM, DL, M1, M3, M4)	3-14

Section Number	Title	Page Number
3.7	Diskettes	3-14
	Loading The Diskette	3-14
	Write Protect Tab	3-14
	Diskette Handling and Storage	3-17

ILLUSTRATIONS

FIGURES

Figure Number	Title	Page Number
1-1	Disk Drive	1-4
2-1	Disk Drive Outline Drawing	2-2
2-2	+ 24 Volt D. C. Current, Configuration 1	2-5
2-3	+ 24 Volt D. C. Current, Configuration 2	2-5
3-1	Electrical Interface Characteristics	3-6
3-2	Control and Data Timing Requirements	3-7
3-3	LSI Circuit Board Assembly	3-11
3-4	Non-LSI Circuit Board Assembly	3-12
3-5	Recording Media	3-17
3-6	Diskette Care and Handling	3-18

TABLES

Table Number	Title	Page Number
2-1	Electrical and Operational Specifications	2-3
2-2	Reliability Specifications	2-6
2-3	Environmental Specifications	2-6
3-1	Drive Interface Lines and Pin Assignments	3-3
3-2	D. C. Power Connector Pin Assignments	3-8
3-3	Option Patching	3-9
3-4	Diagnostic Mode Of Operation	3-15

SECTION 1

GENERAL DESCRIPTION

INTRODUCTION

This document provides required information in order to evaluate or incorporate Tandon's disk drive into a system.

Tandon Corporation's Model Numbers TM848-1E and TM848-2E, eight-inch flexible drives are full-feature, microprocessor-controlled drives. They may be installed in one-half the space normally required for an eight-inch drive. They are compact data storage devices that use an IBM-formatted, industry standard, eight-inch diskette. Both drives are 48 tracks per inch recording devices.

The Model TM848 series of drives are capable of reading and writing in single-density format on a diskette, using a proprietary read/write head patented by Tandon. In addition, both drives have a double density capability when Modified Frequency Modulation (MFM) or other appropriate recording techniques are used. The encoding and decoding of the data is done by the user's controller. The Model TM848-1E drive uses one side of the diskette for data storage. The Model TM848-2E drive doubles data storage capabilities by using both sides of the diskette.

1.1 SCOPE OF THE DOCUMENT

This document contains a description of the major features, physical and functional specifications, mounting and power requirements, the interface, and typical timing characteristics of the TM848-1E and TM848-2E drives.

1.2 PURPOSE OF THE DRIVE

The TM848-1E and TM848-2E drives are rotating disk memories designed for random access data entry, storage, and retrieval applications. Typical applications include

intelligent terminal controllers, micro-computers, word processing systems, data communication systems, error logging, program loading, and point-of-sale terminals.

1.3 MAJOR FEATURES

MICROPROCESSOR CONTROL

The TM848-1E and TM848-2E drives feature an onboard microprocessor. This microprocessor provides six major features:

1. Buffered seek capabilities.
2. Improved head positioning accuracy with reduced hysteresis.
3. Write current switching for optimal data recording quality.
4. True Ready signal.
5. Internal diagnostics (strappable).
6. Power On Self-Tests.

WRITE PROTECT

When a write protected diskette is inserted into the drive, the write electronics are disabled.

DAISY CHAIN CAPABILITY

The drive provides the address selection and gating functions necessary to daisy chain a maximum of four units at the user's option. The last drive on the daisy chain terminates the interface. The terminations are accomplished by a resistor array plugged into a DIP socket.

INTERNAL TRIM ERASE

The drive provides the control signals necessary for proper trim erasure of data.

INDUSTRY STANDARD INTERFACE COMPATIBILITY

The drive is compatible with controllers that use an industry standard interface.

ACTIVITY INDICATOR

An activity indicator, located on the front panel, is automatically illuminated when the drive is selected. This front panel L.E.D. is also used as an indicator in the diagnostic mode.

DIRECT DRIVE, BRUSHLESS D. C. MOTOR

The spindle motor is a crystal controlled, direct drive, brushless D. C. motor for improved motor start time, and speed accuracy.

COMPACT SIZE

The reduced size of the drive occupies only one-half the mounting space required for a conventional drive.

DISKETTE LEVER LOCK SOLENOID

The diskette lever lock solenoid is controlled by the host system.

1.4 FUNCTIONAL DESCRIPTION

The drives are fully self-contained, and require no operator intervention during

normal operation. Each drive consists of a direct drive, spindle system, a head positioning system, and a read/write system.

The TM848-1E is a single-sided drive. The TM848-2E is a double-sided drive. The only difference between the two drives is the number of heads. The circuit board is identical for both models.

When the diskette lever is opened, access is provided for the insertion of a diskette. The diskette's jacket is accurately positioned by plastic guide rails. Its location is ensured by the back stop and disk ejector.

Closing the diskette lever activates the cone/clamp system, resulting in accurate centering and clamping of the diskette to the drive hub. The drive hub is driven at a constant speed of 360 RPM by a crystal-controlled, direct drive, brushless D. C. motor. The head is loaded into contact with the recording medium whenever the diskette lever is latched.

The heads are positioned over the desired track by means of a stepper motor/band assembly and its associated electronics. This positioner uses a 3.6 degree rotation to cause a one track linear movement.

When a write-protected diskette is inserted into the drive, the Write Protect sensor disables the write electronics of the drive, and a Write Protect status output signal is available to the interface. When performing a write operation, a 0.013-inch wide, nominal, data track is recorded. Then, this track is tunnel erased to 0.012-inch, nominal.

Data recovery electronics include a low-level read amplifier, filter, differentiator, zero crossover detector, and digitizing circuits. No data-clock separation is provided.

In addition, the drive is supplied with the following sensor systems:

1. A Track 0 sensor detects when the Head/Carriage Assembly is positioned over Track 0.
2. The TM848-2E has two index sensors, each consisting of an infrared L.E.D.

light source and a phototransistor, positioned to generate a signal when an index hole on the diskette is detected. The drive can determine if a single-sided or double-sided diskette is installed. This output signal is present at the interface.

3. A Write Protect sensor disables the write electronics when a write-enable tab is removed from the diskette.

POWER ON SELF-TESTS

The drive conducts a power on self-test as part of the normal power on sequence. Two of the tests do not require a diskette to be inserted. These tests are: the head carriage stepping in, away from, Track 0, and the head carriage stepping out toward Track 0. Failure of either of these tests is indicated on the front panel L.E.D. by the following flashing sequence:

- 3 flashes, then 2: Fails to step in from Track 0 or Track 0 sensor is always equal to zero.
- 3 flashes, then 3: Fails to step out to Track 0 or Track 0 sensor is always equal to one.

A third test monitors the index sensors whenever the diskette lever is closed, and must have a diskette inserted into the drive. If the diskette lever is closed without a diskette in place, or the spindle motor fails to operate, an error message flashes on the front panel L.E.D. in the following sequence:

- 3 flashes, then 4: No index pulse with lever closed.

Opening and closing the diskette lever is required to repeat a test that has failed. The diskette lever must be left open to complete an error cycle.

1.5 PHYSICAL DESCRIPTION

A representative drive is shown in Figure 1-1. The drive can be mounted in a vertical or horizontal plane. However, the logic circuit board must be on the uppermost side when the drive is mounted horizontally.

The spindle is rotated by a direct drive, brushless D. C. motor with an integral tachometer. The crystal-controlled servo circuit and tachometer control the speed of the spindle.

Operator access for diskette loading is provided via a horizontal slot located at the front of the drive.

The read/write double-head assembly is positioned by a split band positioner mounted to a microprocessor-controlled stepper motor. The read/write heads are glass-bonded, ferrite/ceramic structures with a life expectancy of 15,000 operating hours.

The control electronics of the drive are mounted on a printed circuit board located above the chassis. Power and interface signals are routed through connectors plugging directly into the logic circuit board. A second circuit board, mounted under the drive, operates the brushless D. C. spindle motor.

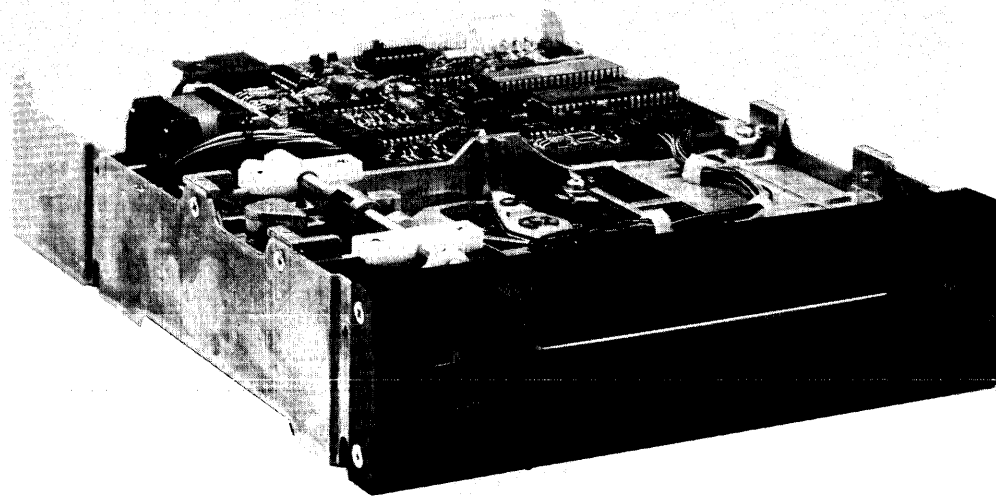

**FIGURE 1-1
DISK DRIVE**

SECTION 2

PRODUCT SPECIFICATIONS

INTRODUCTION

This section contains the mechanical, electrical, reliability, and environmental specifications for the TM848-1E and TM848-2E drives.

2.1 MECHANICAL SPECIFICATIONS

Figure 2-1 contains the physical dimensions of the drive.

2.2 ELECTRICAL AND OPERATIONAL SPECIFICATIONS

The electrical and operational specifications are located in Table 2-1.

2.3 RELIABILITY SPECIFICATIONS

The reliability specifications are located in Table 2-2.

2.4 ENVIRONMENTAL SPECIFICATIONS

The environmental specifications are located in Table 2-3.

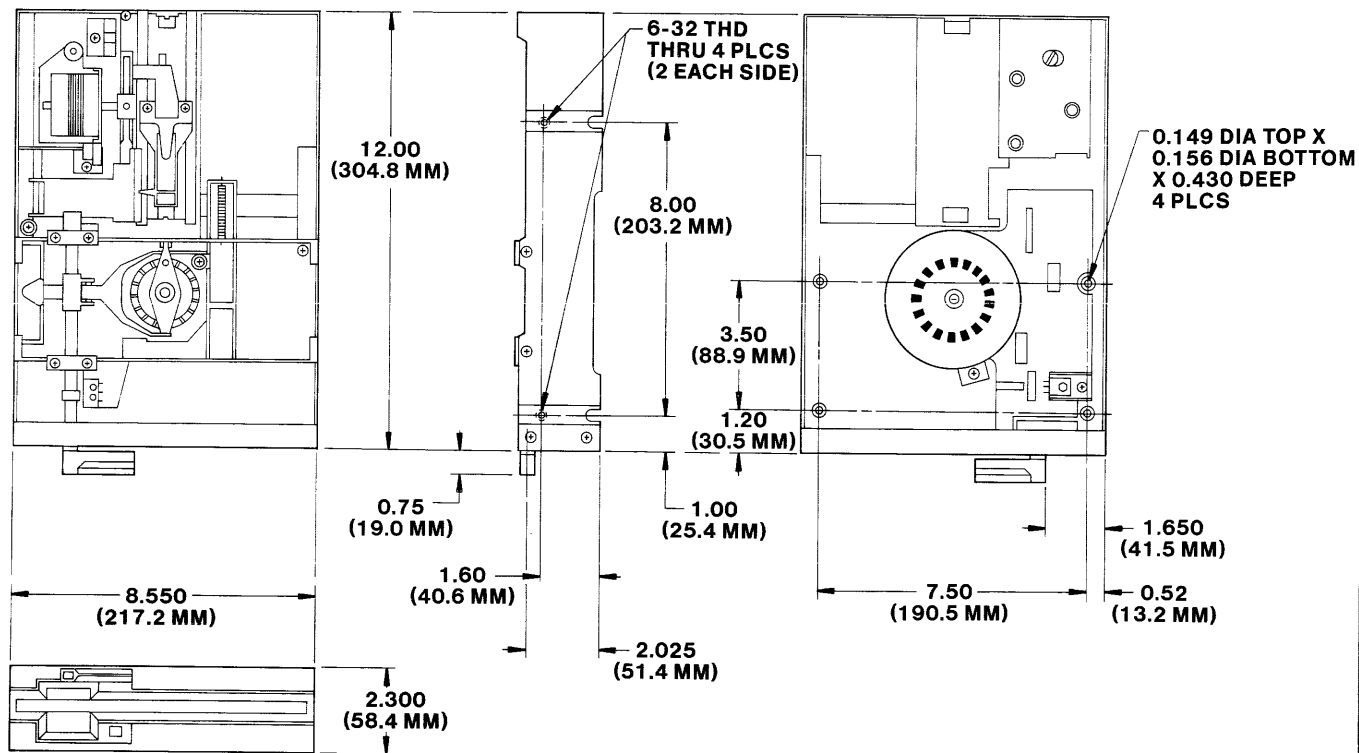

- NOTES: 1. DIMENSIONS ARE GIVEN IN INCHES. METRIC EQUIVALENTS ARE IN PARENTHESES.
 2. TOLERANCE ON ALL DIMENSIONS IS $\pm .020$ INCH.
 3. WEIGHT IS APPROXIMATELY 5.7 POUNDS.

FIGURE 2-1
 DISK DRIVE OUTLINE DRAWING

**TABLE 2-1
ELECTRICAL AND OPERATIONAL SPECIFICATIONS**

Media	203.20 millimeter, 8-inch IBM industry-standard diskette
Media Life (for reference only)	3×10^6 passes per track
Tracks Per Inch	48 TPI, both drives
Tracks Per Drive	
TM848-1E	77 tracks per drive
TM848-2E	154 tracks per drive, 77 per side
Track Spacing	0.529 millimeter, 20.8 milinches
Inside Track Radius	
Both Drives, Side 0	51.50 millimeters, 2.03 inches
TM848-2E, Side 1	49.42 millimeters, 1.95 inches
Outside Track Radius	
Both Drives	91.75 millimeters, 3.61 inches
TM848-2E, Side 1	89.64 millimeters, 3.53 inches
Head Life	15,000 media contact hours
Disk Rotational Speed, microprocessor controlled	360 RPM \pm 1.5 percent
Instantaneous Speed Variation (ISV)	\pm 1 percent
Motor Start Time	150 milliseconds, maximum
Seek Time, Track to Track	3 milliseconds, minimum
Head Settling Time	15 milliseconds
Average Track Access Time, including head settling time	91 milliseconds
Data Transfer Rate	500,000 bits per second

**TABLE 2-1 (CONTINUED)
ELECTRICAL AND OPERATIONAL SPECIFICATIONS**

Flux Reversals Per Inch (FRPI), inside track	6,536 FRPI
Both Drives, Side 0	
TM848-2E, Side 1	6,816 FRPI
Unformatted Recording Capacity	
TM848-1E	0.8 megabyte per disk
TM848-2E	1.6 megabytes per disk
D. C. Voltage and Current Requirements	
+ 24 volts D. C. Power	+ 24 volts, ± 10 percent at 700 milliamperes, typical. For surge current requirements, see Figures 2-2 and 2-3.
+ 5 volts D. C. Power	+ 5 volts, ± 5 percent at 450 milliamperes, typical
Typical Current Requirements For + 24 volts D. C.	
Spindle Motor	170 milliamperes
Stepper Motor	400 milliamperes
Electronics	130 milliamperes
Power Dissipation	20 watts, typical
Shipment	When prepared for shipment by Tandon, the drive meets the requirements of NSTA preshipment test procedure Project 1A.

Configured for stepper motor enabled during motor start, 2.25 amps typical surge.

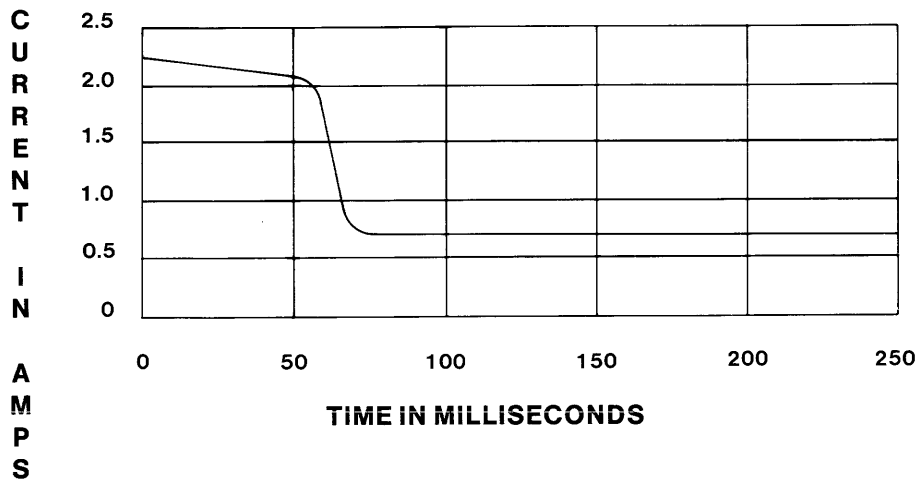

FIGURE 2-2
+24 VOLT D. C. CURRENT, CONFIGURATION 1

Configured for stepper motor disabled until motor comes up to speed, 1.8 amps typical surge.

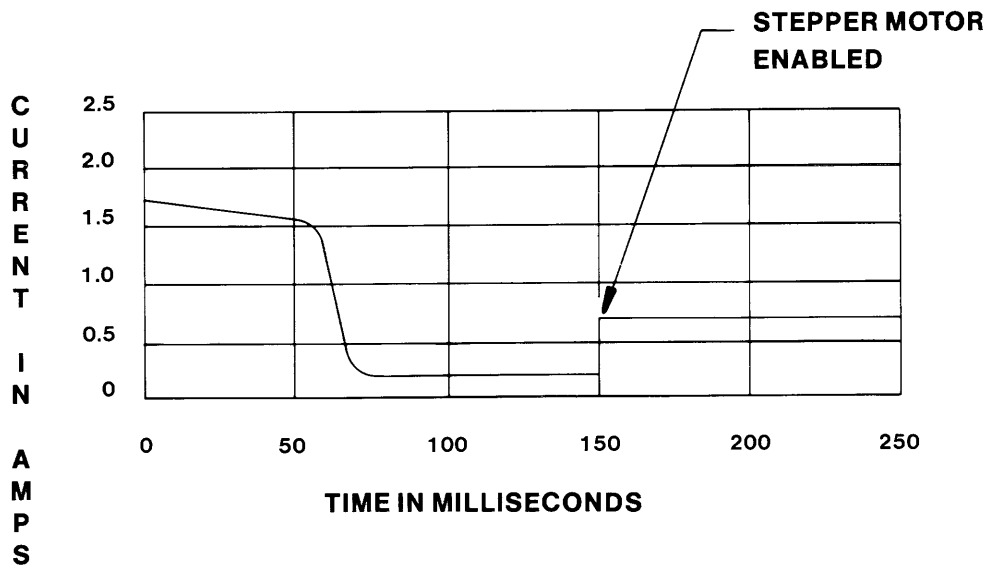

FIGURE 2-3
+24 VOLT D. C. CURRENT, CONFIGURATION 2

Tandon

CORPORATION, CHATSWORTH, CALIFORNIA 91311

179049-001
REV. A

**TABLE 2-2
RELIABILITY SPECIFICATIONS**

<p>Error Rates, maximum, exclusive of external sources, e.g.: electronics, defective and contaminated diskettes</p> <p>Soft Errors (Recoverable)</p> <p>Hard Errors (Nonrecoverable)</p> <p>Seek Errors</p> <p>Mean Time Between Failures</p> <p>Mean Time To Repair</p>	<p>One in 10^9 bits</p> <p>One in 10^{12} bits</p> <p>One in 10^6 seeks</p> <p>10,000 power-on hours</p> <p>30 minutes</p>
--	---

**TABLE 2-3
ENVIRONMENTAL SPECIFICATIONS**

<p>Temperature</p> <p>Operating, media dependent</p> <p>Nonoperating</p> <p>Relative Humidity</p> <p>Operating, noncondensing, media dependent</p> <p>Nonoperating, noncondensing</p>	<p>4.4°C to 46°C, 40°F to 115°F</p> <p>-40°C to 71°C, -40°F to 160°F</p> <p>20-to-80 percent</p> <p>5-to-95 percent</p>
---	---

SECTION 3

OPERATION

INTRODUCTION

This section contains information on how to unpack, check out, install, and operate the TM848-1E and TM848-2E drives.

3.1 UNPACKING THE DRIVE

The drives are packaged in protective containers to minimize the possibility of damage during shipment. The following list is the recommended procedure for unpacking the drive.

1. Place the container on a flat work surface.
2. Remove the upper half of the container.
3. Remove the drive from the lower half of the container.
4. Check the contents of the container against the packing slip.
5. Investigate the contents of the container for possible damage.
6. Notify the carrier immediately if any damage is found.

3.2 PREINSTALLATION CHECKOUT

Before applying power to the drive, the following inspection should be conducted:

1. Check to ensure that the diskette lever opens and closes.
2. When the lever is moved to an open position, the head arm raises.

3. Remove the cardboard shipping insert, and retain for future shipment.
4. Ensure that the front panel is secure.
5. Ensure that the circuit board is secure.
6. Ensure that the connectors are firmly seated.

3.3 MOUNTING THE DRIVE

The drive has been designed so it may be mounted in any plane, i.e.: upright, horizontal, or vertical. When mounted horizontally, the Logic circuit board side of the chassis must be the top side.

Eight holes are provided for mounting: two on each side and four on the bottom of the housing (see Figure 2-1). The two mounting holes on each side are tapped for 8-32 screws. The four mounting holes on the bottom require 8-32 thread forming screws. When installed in either plane, horizontal or vertical, only two mounting screws are required to securely hold the drive in place.

Optional straps are available to permit two drives to be attached together for installation in standard width drive openings.

Any mounting scheme in which the drive is part of the structural integrity of the enclosure is not permitted. Mounting schemes should allow for adjustable brackets or incorporate resilient members to accommodate tolerances. In addition, it is recommended that mounting schemes include no more than two mounting surfaces.

The drive is manufactured and tested with some critical internal alignments that must be maintained. Hence, it is important that the mounting hardware not introduce significant stress on the chassis.

DUST COVER

The design of an enclosure should incorporate a means to prevent contamination from loose items, e.g., dust, lint, and paper chad since the drive does not have a dust cover.

COOLING

Heat dissipation from a single drive is normally 20 watts, 68 BTU per hour, under high load conditions. When the drive is mounted so the components have access to a free flow of air, normal convection cooling allows operation within the specified temperature range.

When the drive is mounted in a confined environment, air flow must be provided to maintain specified air temperatures in the vicinity of the motors, printed circuit boards, and diskettes.

When forced air is used, air flow must be directed outward from the drive. Do not intake air through the drive or heads and diskettes.

3.4 INTERFACE CONNECTIONS

Interface connections for the TM848-1E and TM848-2E are made via a user-supplied, fifty-pin, flat ribbon connector, 3M Scotchflex, Part Number 3415, or its equivalent. This connector mates directly with the circuit board connector at the rear of the drive.

The interface description of the connectors, and the location of each one, is contained in this section. Interface lines are located in Table 3-1. D. C. power connector pin assignments are located in Table 3-2, Section 3.5 of this manual.

The signal wire harness should be of the flat ribbon or twisted pair type, have a maximum length of ten feet, and have a 26-to-28 gauge conductor compatible with the connector to be used. It is recommended that the interface cable have a characteristic impedance of 100 ohms.

All interface signals are TTL compatible. Logic true (low) is +0.4 volt maximum. Logic false (high) is +2.4 volts minimum.

INPUT CONTROL LINES

These input lines are individually terminated through a 150 ohm resistor pack installed in the dip socket located at integrated circuit location RP5 (or RP1 in the Large Scale Integration version). In a single-drive system, this resistor pack should be installed to provide the proper terminations. In a multiple-drive system, only the last drive on the interface is to be terminated. All other drives on the interface must have the resistor pack removed.

The drive can terminate the following input lines:

1. Direction
2. Step
3. Write Data
4. Write Gate
5. In Use
6. Side Select (TM848-2E only)
7. Write Current Switch
8. Head Load

MOTOR ON CONTROL

The Motor On Control lines are used to control the spindle motor. With the MOL jumper in (factory installed), the Motor On Control lines are low true. With the MOH jumper installed (optional), the Motor On Control lines are high true (see Table 3-3 located in Section 3.6).

DRIVE SELECT LINES

The Drive Select lines provide a means of selecting and deselecting a drive. These four lines, DS1 through DS4, allow independent selection of up to four drives attached to the controller.

When the signal logic level is true (low), the drive electronics are activated, and the drive is conditioned to respond to Step or to Read/

**TABLE 3-1
DRIVE INTERFACE LINES AND PIN ASSIGNMENTS**

Ground	Pin	Signal
1	2	Write Current Switch
3	4	Motor On Control 1
5	6	Motor On Control 2
7	8	True Ready, (Motor On Control 3, Optional)
9	10	Two Sided (Strappable) (TM848-2E only)
11	12	Disk Change (Strappable)
13	14	Side Select (TM848-2E only)
15	16	In Use Indicator (Strappable)
17	18	Head Load Line/Motor Control
19	20	Index
21	22	Ready
23	24	Motor On Control 4
25	26	Drive Select 1 (Side Select Option, TM848-2E only)
27	28	Drive Select 2 (Side Select Option, TM848-2E only)
29	30	Drive Select 3 (Side Select Option, TM848-2E only)
31	32	Drive Select 4 (Side Select Option, TM848-2E only)
33	34	Direction Select (Side Select Option, TM848-2E only)
35	36	Step
37	38	Write Data
39	40	Write Gate
41	42	Track 0
43	44	Write Protect
45	46	Read Data
47	48	Alternate I/O
49	50	Alternate I/O

Write commands. When the signal logic level is false (high), the input control lines and the output status lines are disabled.

The Drive Select address is determined by a select shunt on the circuit board. Drive Select lines 1 through 4 provide a means of daisy chaining a maximum of four drives to a controller. Only one can be true (low) at a time. An undefined operation might result if two or more drives are assigned the same address or if two or more Drive Select lines are in the true (low) state simultaneously. A Drive Select line must remain stable in the true (low) state until any operation in progress (Step, Read/Write) is completed.

Using Side Select options 1B through 4B, Drive Select lines may be used as Side Select lines for the TM848-2E (see Section 3.6).

**DIRECTION SELECT AND STEP LINES
(TWO LINES)**

When the drive is selected, a true (low) pulse on the Step line, with a time duration greater than one microsecond, initiates the access motion. The direction of motion is determined by the logic state of the Direction Select line when a step pulse is issued. The motion is toward the center of the disk if the Direction Select line is in the true (low) state. The direction of motion is away from the center of the disk if the Direction Select line is in the false (high) state.

To ensure proper positioning, the Direction Select line should be stable at least 1 microsecond prior to the corresponding rising edge of the step pulse, and remain stable 100 nanoseconds after it.

NOTE

TM848-1E and TM848-2E drives include a microprocessor-controlled buffered seek capability. The controller may issue step pulses of one microsecond minimum width, and fifteen microseconds minimum spacing between trailing edges. Internal drive electronics issue step commands at a rate of three milliseconds.

The drive electronics ignore step pulses when one of five conditions exists:

1. The Write Gate is true (low).
2. The Direction Select is false (high), and the head is positioned at Track 0.
3. The drive is not selected.
4. When trying to seek beyond Track 76.
5. When the diskette lever is opened.

COMPOSITE WRITE DATA

When the drive is selected, this interface line provides the bit serial Composite Write Data pulses that control the switching of the Write Current in the selected head. The write electronics must be conditioned for writing by the Write Enable line.

For each high-to-low transition on the Composite Write Data line, a flux change is produced at the write head gap. This causes a flux change to be recorded on the media.

When a double-frequency type encoding technique is used in which data and clock form the combined Write Data signal, it is recommended that the repetition of the high-to-low transitions, while writing all zeros, be equal to the nominal data rate, ± 0.1 percent, and the repetition of the high-to-low transitions, while writing all ones, be equal to twice the nominal data rate, ± 0.1 percent.

Host controllers may implement write precompensation circuits that recognize worst case

patterns and adjust the Write Data waveform. Although a value cannot be specified for write precompensation, Tandon suggests a value of 125 nanoseconds for systems using MFM double density recording format.

WRITE GATE

When this signal is true (low), the write electronics are prepared for writing data and the read electronics are disabled. This signal turns on Write Current in the selected Read/Write head. Data is written under the control of the Composite Write Data and Side Select input lines. When the Write Gate line is false (high), all write electronics are disabled.

When a write protected diskette is installed in a drive, the write electronics are disabled, irrespective of the state of the Write Gate or Side Select lines. With the NP jumper installed, a diskette cannot be write protected.

NOTE

Changes of state of the Write Gate line should occur before the first Write Data pulse.

IN USE

This strappable feature controls the lever lock solenoid when the DL option is installed.

WRITE CURRENT SWITCH

Normally, Write Current switching is accomplished by the host controller. A true (low) level on this line reduces the Write Current. Using option IC, the drive automatically reduces Write Current at Track 43.

SIDE SELECT

The Side Select interface line, available only on Tandon's TM848-2E, defines which side of a two-sided diskette is used for reading or writing. An open circuit, false (high) level

selects the Read/Write head on side zero, the lower head of the drive. A true (low) level on this line selects the Read/Write head on side one, the upper head of the drive. When switching from one head to the other, a 100 microsecond delay is required before any Read or Write operation can be initiated.

HEAD LOAD LINE/MOTOR CONTROL

This line may be used to control the spindle motor and/or the lever lock solenoid (see Section 3.6).

OUTPUT CONTROL LINES

There are eight output lines, five of which are standard and three of which are strappable features. The standard output signals are: Index/Sector, Track 0, Write Protect, Read Data, and Ready. The strappable output signals are Disk Change, Two-Sided, and True Ready.

INDEX

The Index signal represents the output of the Index sensor. An Index pulse is provided once every revolution, 166.67 milliseconds nominal, to indicate the beginning of a track to the controller. The leading edge of this signal must always be used to ensure timing accuracy. The Index line remains in the true (low) state for the duration of the Index pulse, which is nominally four milliseconds.

TRACK 0

When the drive is selected, the Track 0 interface signal indicates to the controller that the Read/Write head is positioned on Track 0, the outermost track. This signal remains true (low) until the Read/Write head is moved away from Track 0. This signal is false (high) when the selected drive's Read/Write head is not on Track 0.

WRITE PROTECT

The Write Protect signal is provided to indicate to the user that a write protected diskette is installed. This signal is true (low) when the diskette's Write Protect notch is uncovered. When the Write Protect signal is false (high), the write electronics are enabled, and write operations can be performed.

READ DATA

The Read Data line transmits data to the controller when the drive is selected and not writing. It provides a pulse for each flux transition recorded and detected on the diskette by the drive electronics. Normally, this signal is false (high). It becomes true (low) for the active state. The Read Data output line goes true (low) for a duration of 200 nanoseconds, ± 50 nanoseconds, for each change recorded on the diskette.

READY

The Ready interface signal indicates a diskette has been inserted into the drive. Ready will not return to the false state until the lever is opened, and is not affected by Spindle Motor Control.

When a single-sided diskette is installed, Ready is active (low) if side zero is selected. Ready is false (high) if side one is selected on the TM848-1E. When a two-sided diskette is installed, Ready is active when either side of the diskette is selected on the TM848-2E.

TRUE READY

The True Ready interface signal indicates the diskette is rotating at 360 RPM, and a seek operation is complete, i.e., the head has settled. This may be used to indicate seek complete when using the buffered seek operation.

NOTE

This is a strappable feature with the Motor Control 3 input signal line.

DISK CHANGE

This strappable feature provides a true (low) signal to the interface when Drive Select is activated if the drive has gone from a Ready to a Not Ready condition while deselected. This line is reset on the true-to-false transition of Drive Select if the drive has gone to a Ready condition.

TWO-SIDED

This option is available only on Model TM848-2E. True (low) indicates that a two-sided diskette is installed.

TYPICAL INTERFACE CHARACTERISTICS

Lines between the controller and the drive have the following characteristics:

$$V_{\text{out True}} = +0.4 \text{ volt maximum at } I_{\text{out}} = 48 \text{ milliamperes, maximum}$$

$$V_{\text{out False}} = +2.4 \text{ volts minimum open collector at } I_{\text{out}} = 250 \text{ microamperes, maximum}$$

Figure 3-1 contains the electrical interface characteristics. Figure 3-2 contains the control and data timing requirements.

3.5 D. C. POWER

D. C. power is supplied to the drive through a six-pin AMP connector, J2, mounted on the circuit board. The mating connector, not

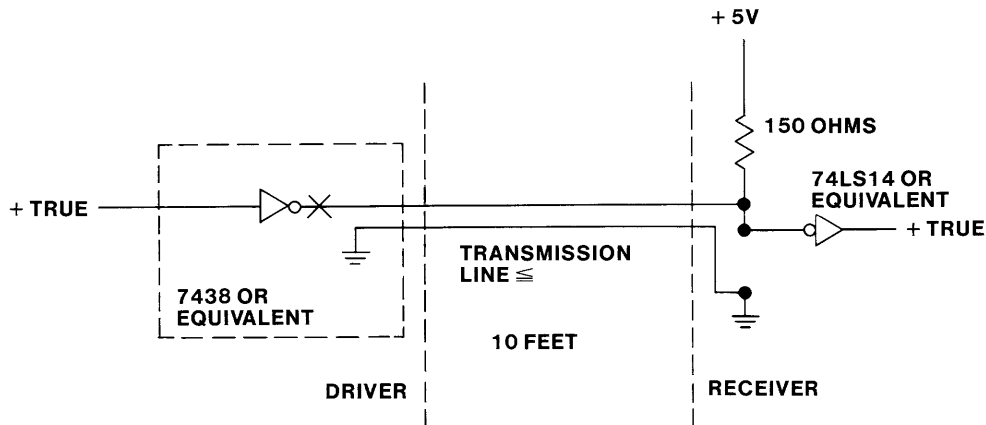
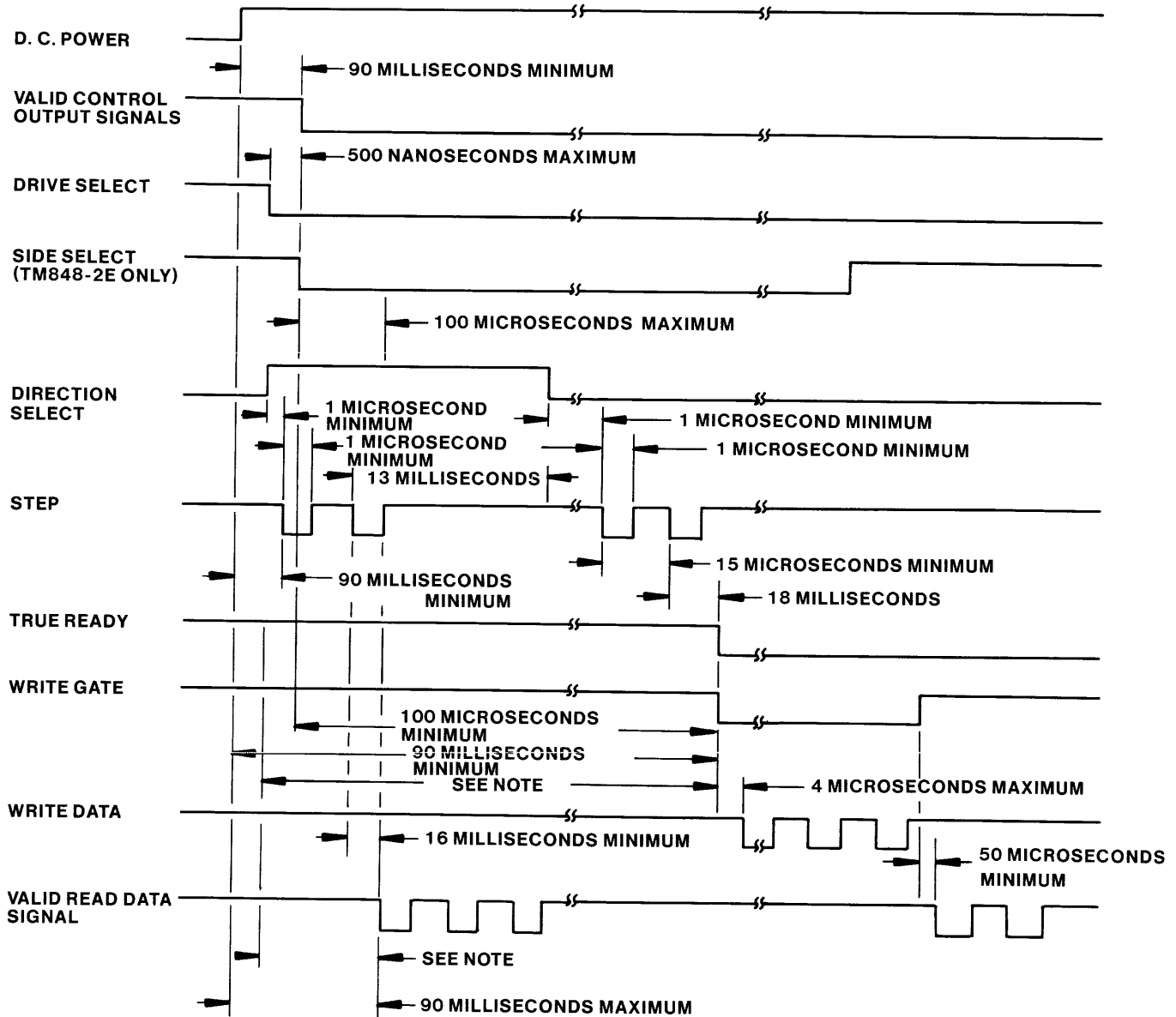

FIGURE 3-1
ELECTRICAL INTERFACE CHARACTERISTICS



NOTE: 150 MILLISECONDS, MINIMUM, DELAY MUST BE INTRODUCED AFTER DRIVE SELECT TO ALLOW TIME FOR THE D. C. MOTOR TO REACH 360 RPM OR THE OPTIONAL TRUE READY LINE MUST BE MONITORED.

**FIGURE 3-2
CONTROL AND DATA TIMING REQUIREMENTS**

supplied, is AMP Part Number 1-480270-0, using AMP contact Part Number 606191-1. Pin assignments are found in Table 3-2.

The chassis should be connected to earth ground to ensure proper operation.

TABLE 3-2 D. C. POWER CONNECTOR PIN ASSIGNMENTS	
Pin	Supply Voltage
1	+24 volts D. C.
2	24 volts Return
3	5 volts Return
5	+5 volts D. C.
6	Return

3.6 DRIVE ADDRESS AND OPTION STRAPPING

The drive address and option strapping is determined by the different jumper configurations required for specific system applications. If jumper configurations are changed, power should be cycled off and on so the microprocessor can recognize the new configuration.

The description of user-selectable options should be used in conjunction with Table 3-3.

Throughout Section 3.6, an X denotes jumper installation, and a dash denotes jumper removed.

DRIVE SELECT (DS1 – DS4)

This option allows the user to daisy chain up to four drives, and to enable one drive at a

time. Drive Select is implemented by shorting one of the four connections, using a shorting plug. The drive comes equipped from the factory with DS1 installed. All outputs are gated with drive select, as set-up at the factory.

DS1	DS2	DS3	DS4	DRIVE SELECT
X	–	–	–	Selects Drive 0 via J1-26.
–	X	–	–	Selects Drive 1 via J1-28.
–	–	X	–	Selects Drive 2 via J1-30.
–	–	–	X	Selects Drive 3 via J1-32.

HEAD SELECT OPTIONS (S1 – S3 and 1B – 4B)

The Side Select options allow the user to select the heads by various means. They are implemented by removing the shorting plug from the DS1 – DS4 option pads.

HEAD SELECT USING DRIVE SELECT

To use the Drive Select lines to select the heads, etch cut S2 and install S3 along with one of the 1B – 4B jumpers. The 1B – 4B control signal selected may not be the same control line used for Drive Select, or an undefined condition results. When the control line that corresponds to the Drive Select jumper is driven low (true), the drive is enabled, and the lower head, Head 0, is selected. When the control line that corresponds to the 1B – 4B jumper is driven low (true), the drive is enabled, and the upper head, Head 1, is selected.

**TABLE 3-3
OPTION PATCHING**

Option	Trace Designator	As Shipped	
		Installed	Not Installed
Drive Select	DS1 – DS4	DS1	DS2 – DS4
Head Select	S1 – S3	S2	S1, S3
Head Select Using Drive Select	1B – 4B		X
Power Save	PS	X	
Stepper Power From Head Load Line	HL		X
Spindle Motor Control	M1, M3, M4	M1, M3	M4
Motor Control Signal, Low True	MOL	X	
Motor Control Signal, High True	MOH		X
Motor Control Select	MC1 – MC4		X
Ready	R	X	
True Ready	TR		X
Lever Lock Solenoid	DL		X
In Use, Lever Lock Option	D		X
In Use, Latched	LL		X
In Use, Not Latched	NL	X	
Disk Change	DC	X	
Two-Sided Diskette Installed	2S	X	
Inhibit Write When Write Protected	WP	X	
Allow Write When Write Protected	NP		X
External Write Current Switch	XC	X	
Internal Write Current Switch	IC		X
Diagnostic Mode	DM		X

HEAD SELECT USING DIRECTION SELECT

During a Read or Write operation, the state of the Direction Select line is undefined. Hence, it may be used to select the desired head. A high enables Head 0. A low enables Head 1. To incorporate this option, etch cut S2 and install S1.

S1	S2	S3	1B	2B	3B	4B	HEAD SELECT
–	X	–	–	–	–	–	Head Select via J1-14.
–	–	X	X	–	–	–	Head Select via J1-26.
–	–	X	–	X	–	–	Head Select via J1-28.
–	–	X	–	–	X	–	Head Select via J1-30.
–	–	X	–	–	–	X	Head Select via J1-32.
X	–	–	–	–	–	–	Head Select via J1-34.

STEPPER MOTOR POWER (PS, PS*, DS, HL)

When the PS jumper is installed, stepper motor power is controlled by the Drive Select line, DS, or the Head Load line, HL. When either line is true (low), the stepper motor is driven with full power, and is ready for a Seek, Read, or Write operation. When either line is false (high), +5 volt stand-by current is supplied to the stepper motor to hold the head carriage assembly in position. When the PS* option is in, the stepper motor continuously receives full power. PS* is diametrically opposite PS (see Figures 3-3 and 3-4).

PS	PS*	DS	HL	STEPPER POWER
–	X	–	–	Stepper Power continuously on.
X	–	X	–	Stepper Power on with Drive Select.
X	–	–	X	Stepper Power on with Head Load line J1-18.

SPINDLE MOTOR CONTROL OPTIONS (M1, M3, M4, MOL, MOH, MC1 – MC4)

M1 is used to enable the motor off delay timer. When this jumper is installed, a five second

turn off delay of the spindle motor is activated on the trailing edge of the Motor Control signal.

With Motor Control using Drive Select or Head Load, the M3 and M4 jumpers determine which method of Motor Control is enabled. If option M3 or M4 jumpers are installed, the Motor On Control, MC1 – MC4, options operate in a logical OR manner with the control signal(s) selected by the M3 and M4 jumpers.

NOTE

If the Motor Delay Timer option (M1) is installed, the five second turn off delay is in effect regardless of which M3/M4 configuration is implemented.

M1	M3	M4	MOTOR CONTROL
X	–	–	Enables five-second motor off delay timer.
–	–	–	Motor Control only with MC1 – M4 options.
–	X	–	Motor Control using Drive Select.
–	–	X	Motor Control using Head Load.
–	X	X	Motor Control using Drive Select and Head Load, logical AND.

MOL	MOH	MC1	MC2	MC3	MC4	MOTOR CONTROL
X	-	-	-	-	-	Motor Control signals are low (true) active.
-	X	-	-	-	-	Motor Control signals are high (true) active.
X	-	X	-	-	-	Motor Control selected via J1-4.
X	-	-	X	-	-	Motor Control selected via J1-6.
X	-	-	-	X	-	Motor Control selected via J1-8.
X	-	-	-	-	X	Motor Control selected via J1-24.

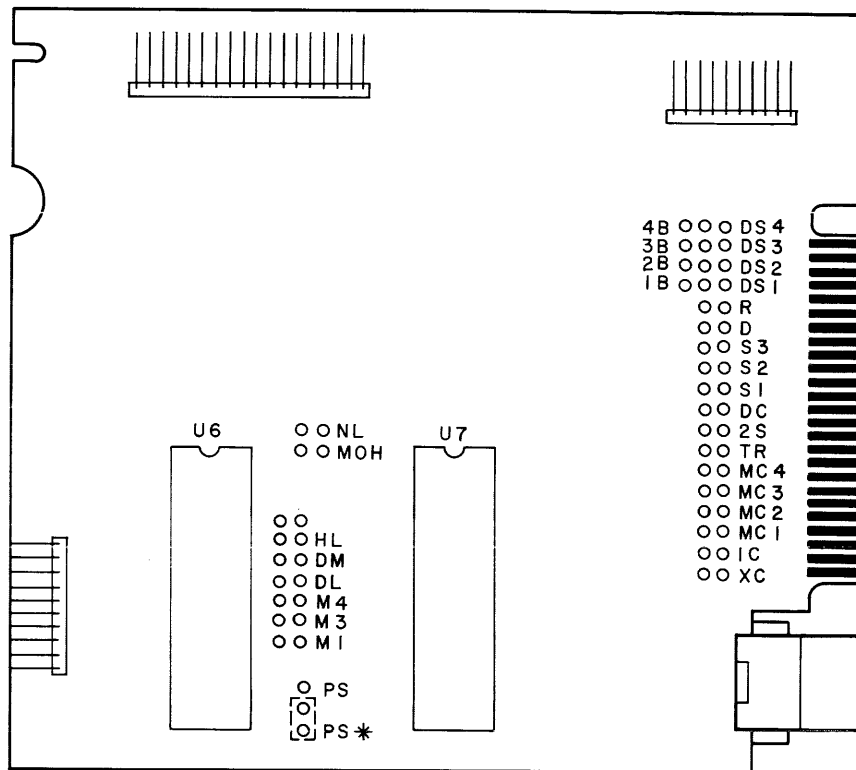
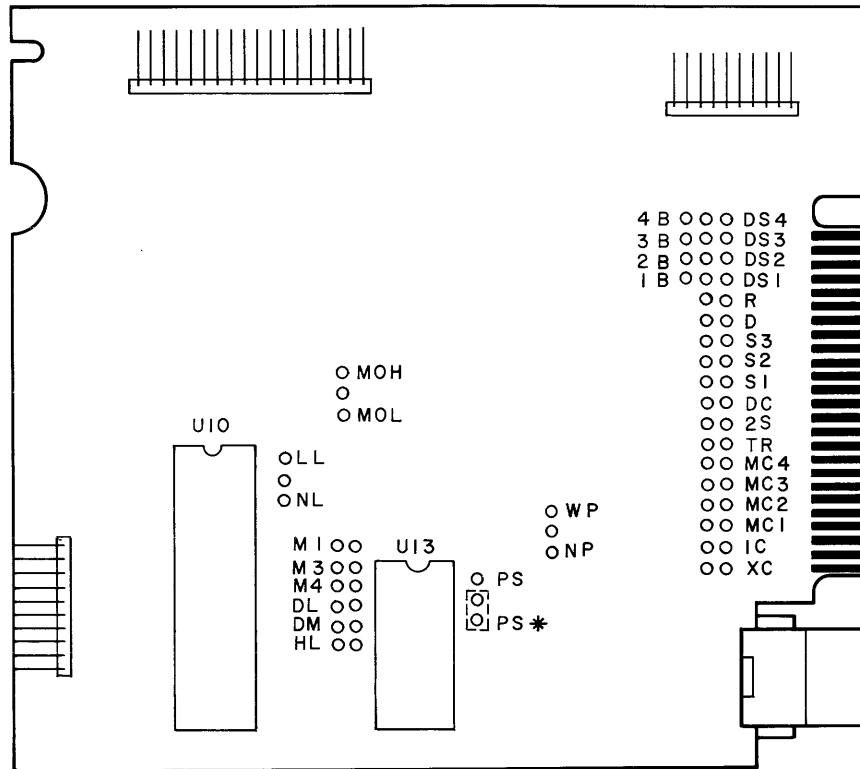

FIGURE 3-3
LSI CIRCUIT BOARD ASSEMBLY



**FIGURE 3-4
NON-LSI CIRCUIT BOARD ASSEMBLY**

READY AND TRUE READY (R AND TR)

When the R jumper is installed, the Ready signal is available at the interface. When the TR jumper is installed, the True Ready signal is available at the interface.

The R jumper is standard, while the TR jumper is optional. These two lines are independent functions, and may be used separately or together.

R	TR	READY OR TRUE READY
X	–	Ready signal via J1-22.
–	X	True Ready signal via J1-8.

NOTE

When using the True Ready option, Motor Control 3 may not be used.

LEVER LOCK OPTIONS (D, DL, LL, NL)

The lever lock solenoid, an optional feature, can be controlled by the In Use interface line J1-16.

D	DL	LL	NL	LEVER LOCK SOLENOID
–	–	–	–	Latched with Drive Select.
X	X	–	X	Latched by In Use via J1-16, true (low). Active energizes solenoid.
X	X	X	–	Latched by In Use via J1-16. Active low, in conjunction with Drive Select, latches the solenoid. The solenoid remains latched until In Use is false (high) on the leading edge of Drive Select.

DISK CHANGE (DC)

This output is used to indicate to the controller that a disk change has been made. The internal signal is gated with Drive Select. When the lever is opened, the Disk Change line goes low (true), and remains low until the trailing edge of the next Drive Select.

DC	DISK CHANGE
–	Disk Change signal not available.
X	Disk Change signal available via J1-12.

TWO-SIDED DISKETTE INSTALLED (2S)

When a two-sided diskette is installed, internal circuitry gates this signal with Drive Select. It sends a low (true) signal to the controller, indicating that a double-sided diskette is installed (index hole two is present). This option is factory installed.

2S	TWO-SIDED DISKETTE
–	Two-sided diskette signal not available.
X	Two-sided diskette signal available via J1-10.

WRITE PROTECT (WP AND NP)

This WP option is used to lock out the Write Gate when a write protected diskette is installed. It is factory installed.

The NP option allows the controller to write on any diskette, whether or not it is write protected. It does not stop the Write Protect signal from being sent on the interface line. This option is implemented by removing WP, and installing NP.

WP	NP	WRITE PROTECT
X	–	Disables Write Protect, for write protected diskette.
–	X	Allows writing on any diskette.

WRITE CURRENT SWITCH (XC AND IC)

The XC option allows the host controller to switch the Write Current independently of the drive's onboard microprocessor. It is factory installed.

To implement the IC option, remove the XC jumper, then install a jumper at IC.

XC	IC	WRITE CURRENT SWITCHING
X	—	External Write Current switch.
—	X	Microprocessor automatically switches Write Current at Track 43.

DIAGNOSTIC MODE OF OPERATION (DM, DL, M1, M3, M4)

The test programs allow the user to test some aspects of drive operation without the use of special test equipment. The programs allow the user to isolate the problems of the drive. The diagnostic mode provides 16 tests (see Table 3-4).

To enter the diagnostic mode:

1. Make a note of which jumpers are installed for normal operating conditions (see Table 3-3).
2. Remove the DL, M1, M3, and M4 jumpers.
3. Install the DM jumper, and supply power to the drive.
4. Using the DL, M1, M3, and M4 jumpers, select the diagnostic test desired by inserting the jumper according to Table 3-4.

To exit the diagnostic mode:

1. Remove power from the drive.
2. Remove the DM, DL, M1, M3, and M4 jumpers.

3. Reinstall the jumpers in their original configuration.
4. Power on the drive.

3.7 DISKETTES

The TM848-1E and TM848-2E drives use an IBM-compatible, eight-inch diskette. Diskettes are available with a single index hole or with multiple (index and sector) holes.

Diskettes with a single hole are used when soft sector format is required. Multiple hole diskettes provide sector information through the use of an index sensor and electronics.

Figure 3-5 illustrates the diskette used with the drive. This recording media is a flexible diskette enclosed in a protective jacket. The diskette, free to rotate within the jacket, is continuously cleaned by its soft fabric lining during normal operation.

LOADING THE DISKETTE

The drive is loaded by inserting the diskette, with its head aperture forward, into the front slot of the drive. Access to the diskette loading slot is obtained by opening the front lever.

The diskette should be carefully inserted until it is solidly against the back stop.

CAUTION

Damage to the center of the diskette may result if the door is closed when the diskette is not properly inserted. This prevents reliable recovery of the recorded data.

WRITE PROTECT TAB

The drive is equipped with a Write Protect Sensor Assembly. This sensor operates in conjunction with the diskette, which has a slot cut in the protective jacket.

**TABLE 3-4
DIAGNOSTIC MODE OF OPERATION**

DL	M4	M3	M1	Test	Description of Test
-	-	-	-	0	Seek to Track 0, and turn on spindle motor. This test seeks the carriage to Track 0, and turns on the spindle motor. It may be used to check the Track 0 status.
-	-	-	X	1	Seek to Track 1, and turn on spindle motor. This test seeks the carriage to Track 1, and turns on the spindle motor. It may be used for index-to-data burst testing with an alignment diskette.
-	-	X	-	2	Seek to Track 38 from Track 0, and turn on spindle motor. This test seeks the carriage to Track 0, then to Track 38. It may be used for radial alignment adjustment with an alignment diskette.
-	-	X	X	3	Seek to Track 38 from Track 76, and turn on spindle motor. This test seeks the carriage to Track 76, then to Track 38. This test, along with the previous one, is used to measure hysteresis.
-	X	-	-	4	Seek to Track 76, and turn on spindle motor. This test seeks the carriage to Track 76, and turns on the spindle motor. This test may be used to check index-to-data burst and azimuth.
-	X	-	X	5	Seek to Track 75, and turn on spindle motor. This test seeks the carriage to Track 75, and turns on the spindle motor.
-	X	X	-	6	Toggle front panel L.E.D. with each revolution of the disk. This test toggles the front panel L.E.D. at the leading edge of each side zero index pulse. A single-sided disk should be used for this test.
-	X	X	X	7	Toggle front panel L.E.D. with each revolution of the disk. This test toggles the front panel L.E.D. at the leading edge of each side one index pulse. A double-sided disk should be used for this test.
X	-	-	-	8	Alternate seek between Track 0 and Track 76 with spindle motor on. This test continuously moves the carriage between Tracks 0 and 76. This test is used to exercise the positioner system.
X	-	-	X	9	Seek to Track 2, and monitor the Track 0 sensor. This test moves the carriage to Track 2, and displays the state of the Track 0 sensor. The Track 0 sensor should change state at Track 2.

**TABLE 3-4 (CONTINUED)
DIAGNOSTIC MODE OF OPERATION**

DL	M4	M3	M1	Test	Description of Test
X	—	X	—	10/A	Monitor the write protect sensor. This test checks the write protect sensor. The front panel L.E.D. should turn on and off by moving a disk, which has the write protect notch covered, in and out of the drive. The L.E.D. is on when write protect is true.
X	—	X	X	11/B	Alternate seek between Track 0 and Track 4 with spindle motor on. This test is used in conjunction with a scope to dynamically test the Track 0 sensor.
X	X	—	—	12/C	Monitor the status of the lever position switch. This test is used to check the lever position switch. The front panel L.E.D. flashes on and off with the opening and closing of the diskette lever position switch.
X	X	—	X	13/D	Alternate seek between Track 74 and Track 76 with spindle motor on. By writing data on Track 75, this test determines if the head movement over that track causes any erasure. A time of 30 milliseconds is allowed for the head to settle at the end of each seek.
X	X	X	—	14/E	Turn spindle motor off. This test turns off the spindle motor.
X	X	X	X	15/F	Flash version number. This test outputs the firmware version number to the front panel L.E.D.

Notes: X = Jumper In
— = Open

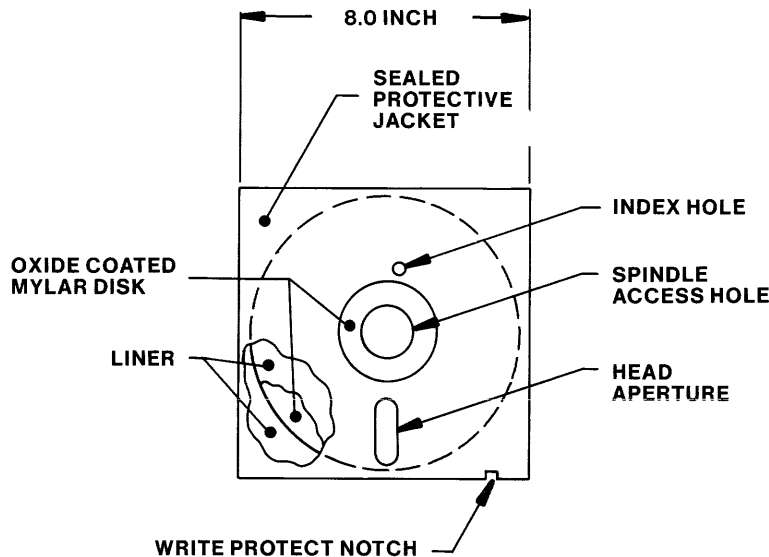

**FIGURE 3-5
RECORDING MEDIA**

When the slot is covered with an optically opaque, self-adhesive tab, the diskette is write enabled. When the tab is removed, the diskette is write protected.

DISKETTE HANDLING AND STORAGE

It is important the diskette be handled and stored correctly so the integrity of the recorded data is maintained. A damaged or contaminated diskette can impair or prevent recovery of data, and can result in damage to the Read/Write heads.

Figure 3-5 contains an illustration of the physical configuration of the diskette. The 7.88-inch diskette is oxide-coated, flexible mylar. It is enclosed in an eight-inch square protective jacket. In addition, openings for the drive hub and diskette index hole are provided.

Figure 3-6 provides some helpful hints on the care and handling of the drive and diskettes. In addition, to ensure trouble-free operation

and to enhance the service life of the diskette, the following handling procedure should be observed.

1. Return the diskette to the protective jacket when not in use.
2. Avoid exposing the diskette to any magnetizing force in excess of 50 oersted.

NOTE

The 50-oersted level magnetizing force is reached approximately three inches from a typical source, e.g., motors, generators, or transformers.

3. To avoid warping the diskette, do not store it in direct sunlight.
4. Do not use a lead pencil or a ballpoint pen to write on the label. Use a felt tipped pen, and mark lightly on the label.

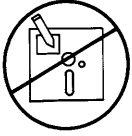

DO NOT WRITE ON THE JACKET WITH PEN OR PENCIL. USE A FELT TIPPED PEN.

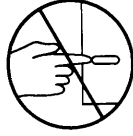

DO NOT TOUCH PRECISION SURFACE WITH YOUR FINGERS.

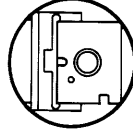

TO AVOID DAMAGE TO THE DISKETTE AND TO YOUR DRIVE, INSERT DISKETTE CAREFULLY UNTIL THE BACKSTOP IS ENCOUNTERED.

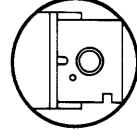

RETURN THE DISKETTE TO ITS JACKET WHEN NOT IN USE.

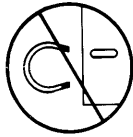

KEEP THE DISKETTE AWAY FROM MAGNETIC FIELDS.

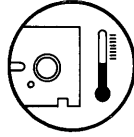

**DISKETTES SHOULD BE STORED AT
10°C to 52°C
50°F to 125°F**

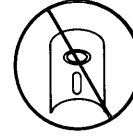

HANDLE WITH CARE; BENDING AND FOLDING MAY DAMAGE DISKETTE.

**FIGURE 3-6
DISKETTE CARE AND HANDLING**

Tandon
CORPORATE OFFICES
20320 PRAIRIE STREET
CHATSWORTH, CA 91311

TELEPHONE NO.: (213) 993-6644
TELEX NO.: 194794
TWX NO.: 910-494-1721

P/N 179049-001A (T5007A 5-83)

PRINTED IN U.S.A.