

KURTA
CORPORATION

Series ONE
The Thin Dimension

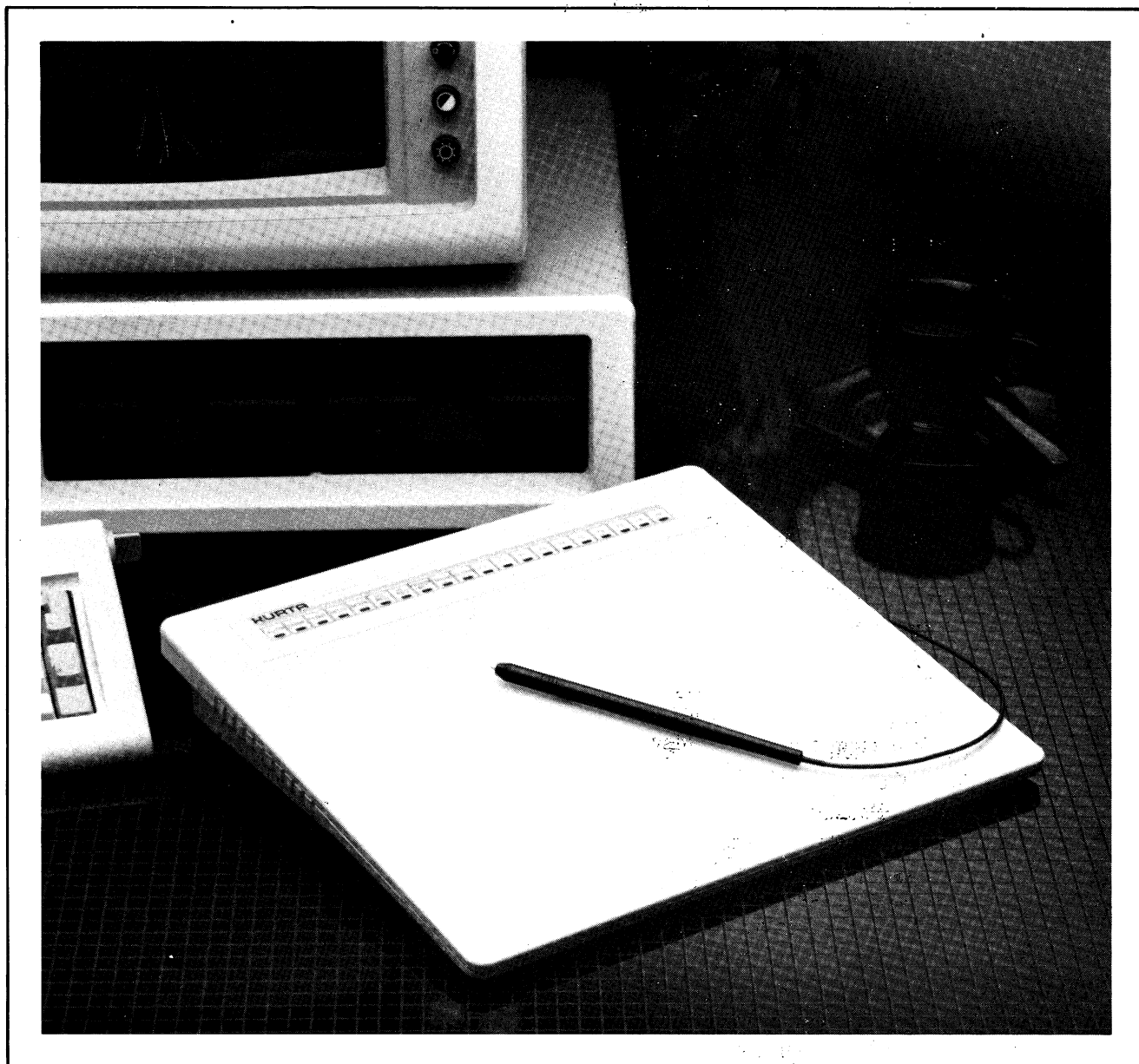

GRAPHICS TABLET
USER'S MANUAL

Series ONE
The Thin Dimension

GRAPHICS TABLET
USER'S MANUAL

Copyright © 1984

FCC RADIO FREQUENCY INTERFERENCE STATEMENT WARNING

This equipment generates and uses radio frequency energy and if not installed and used properly, that is, in strict accordance with the manufacturer's instructions, may cause interference to radio and television reception. It has been type tested and found to comply with the limits for a Class B computing device in accordance with the specifications in Subpart J of Part 15 of FCC Rules, which are designed to provide reasonable protection against such interference in a residential installation. However, there is no guarantee that interference will not occur in a particular installation. If this equipment does cause interference to radio or television reception, which can be determined by turning the equipment off and on, the user is encouraged to try to correct the interference by one or more of the following measures:

- Reorient the receiving antenna
- Relocate the computer with respect to the receiver
- Move the computer away from the receiver
- Plug the computer into a different outlet so that computer and receiver are on different branch circuits.

If necessary, the user should consult the dealer or an experienced radio/television technician for additional suggestions. The user may find the following booklet prepared by the Federal Communications Commission helpful: "How to Identify and Resolve Radio-TV Interference Problems." This booklet is available from the US Government Printing Office, Washington, D.C. 20402 Stock No. 004-000-00398-4."

NOTE: Your graphics tablet has been granted an equipment authorization of compliance with Federal Communication Commission Rules Part 15 of Equipment Class B Computing Device Peripherals under the following certification:

DMA 8C9 SERIESONE

INTRODUCTION

Welcome to a new dimension of computer graphics! Your Series ONE Graphics Tablet offers a wide variety of graphic features that will allow you to draw, menu select and add the dimension of graphics to your computer system.

Your graphics tablet is compatible with many graphics software packages available for personal computers supporting an RS232 serial interface. It may also be used in conjunction with BASIC, assembler, or other language programs that you may write for your own applications. In fact, we have included some BASIC programs that will show you how the tablet works, and also may help get you started writing your own applications programs.

The Series ONE Graphics Tablet is microprocessor driven and uses a pen or optional cursor to generate output data consisting of x and y coordinates as well as pen status information. A soft keyboard provides tablet control with the touch of the pen or optional cursor. The microprocessor will also accept commands loaded from the host computer. Programmable point, draw, delta, auto, and menu modes as well as origin relocation and resolution scaling support many tablet, workstation and keyboard applications.

Your Tablet can output data scaled to match the host monitor pixel requirements. The host can also program a change to other resolutions for printer output or data calculations. The built-in, powerful microprocessor minimizes host processing, control, and management tasks.

The following pages detail configuration information, setup instructions, and examples of BASIC programs that demonstrate how your Tablet works. Take a few minutes to familiarize yourself with them as you become acquainted with the unit.

TABLE OF CONTENTS

FCC RADIO FREQUENCY INTERFERENCE STATEMENT WARNING	1
INTRODUCTION	2
TABLE OF CONTENTS	3
SYSTEM CONFIGURATION AND SETUP	4
Configuration	
Inventory Checklist	
System Setup	
HARDWARE CONFIGURATION AND SETUP	5
Mode/Baud Switch Setup	
Program Switch Setup	
PEN AND CURSOR ASSEMBLIES	7
MENU KEYBOARD	8
OPERATION	9
MAINTENANCE AND SERVICE	10
TROUBLESHOOTING	11
SPECIFICATIONS	12
GLOSSARY	13
APPENDIX 1: ORIGIN SET AND RESOLUTION	14
APPENDIX 2: RS232 INTERFACE CONNECTOR	15
APPENDIX 3: INPUT FORMATS	16
Single Character Input Format	
Program Message Input Format	
Resolution Message Input Format	
APPENDIX 4: OUTPUT FORMATS	18
APPENDIX 5: MENU CODER	19

SYSTEM CONFIGURATION AND SETUP

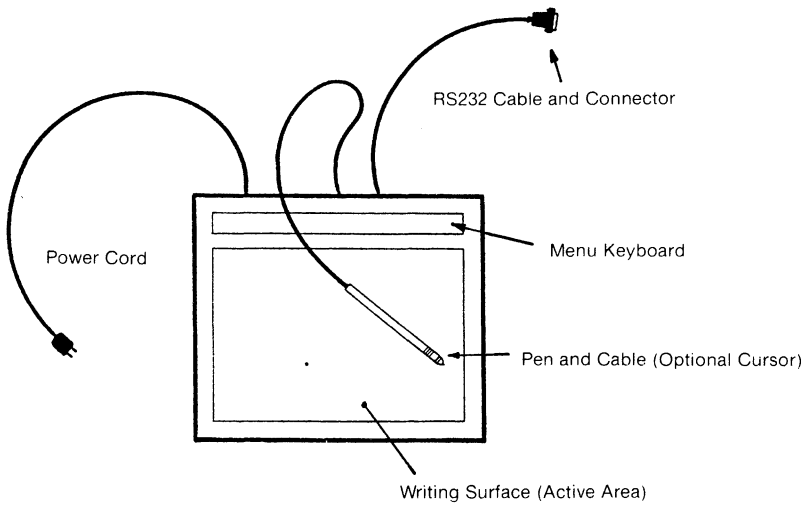

KURTA SERIES ONE GRAPHICS TABLET

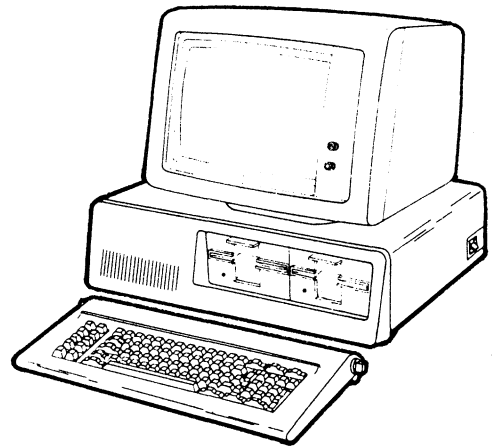

Mini, Micro or Personal Computer with an RS232 Interface

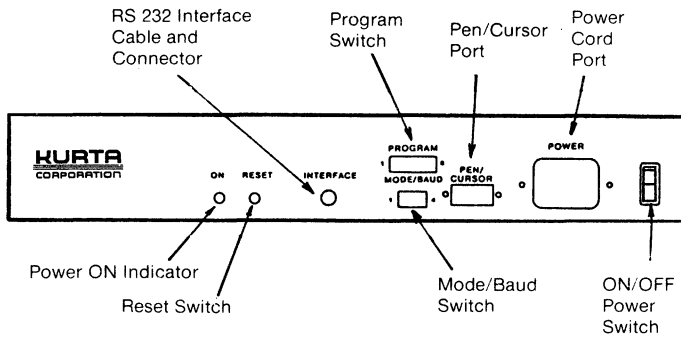

KURTA SERIES ONE REAR PANEL

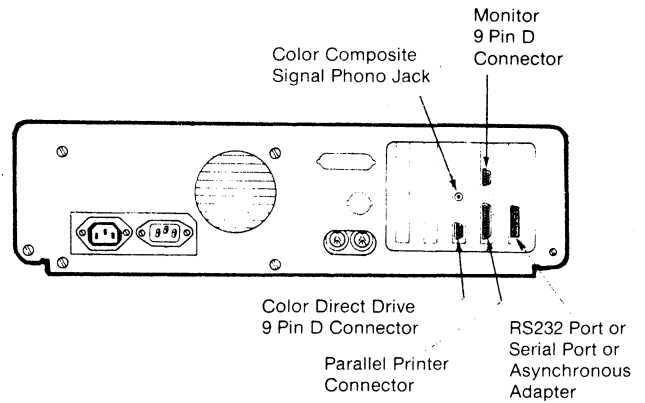

REAR PANEL

INVENTORY CHECKLIST

- Series ONE Graphics Tablet includes RS232 Cable and Connector
- Pen and/or Optional Cursor
- Power Cord
- Menu Overlay
- Writing Surface Overlay
- User's Manual and/or
- Software Package

***NOTE:** Three-pronged power cord is required for proper tablet operation as well as for safety and RFI reasons.

SYSTEM SETUP

- With tablet *and* computer power OFF:
- Set Mode/Baud Switches 3 & 4 and Program Switch 3 to computer Baud rate.
 - Verify Program Switch and Mode Switch are set to software program requirements
 - Connect Tablet RS232 cable to computer RS232 serial port or asynchronous port
 - Plug in pen/cursor to pen/cursor port
 - Connect Power cord to tablet
 - Plug in tablet power cord to 115 VAC 60 Hz*
 - Turn on tablet
 - Verify tablet POWER ON indicator is lit.
 - Turn on computer

Your graphics system is now ready for use. You may either load a graphics software diskette (you need to load DOS first) and begin using your new tablet and graphics software, or you may go to the OPERATIONS section and learn a bit more about your tablet first.

HARDWARE CONFIGURATION AND SETUP

MODE/BAUD SWITCH SETUP

The Mode/Baud Switch on the rear panel sets the default modes of operation and baud rates at POWER ON or RESET. The user can subsequently change the modes using the menu if the menu has been turned on by program switch or external input. In addition, modes may be externally programmed. (See Appendix 3: Input Formats.)

NOTE: Tablet Baud rate must be set to computer Baud rate for proper operation.

MODES OF OPERATION:

AUTO: continuous data output when pen or cursor is within proximity of the surface active area or pen/cursor switch is activated.

DRAW: continuous data output when writing, tracing or drawing and pen/cursor switch is activated.

POINT: single point data output upon pen/cursor switch activation.

DELTA: single data output for each 0.01 inch predefined increment of pen/cursor movement when pen/cursor switch is activated.

BAUD RATE:

Data transmission speed expressed in bits/second. Eight standard Baud rates are provided. See Table at right and Program Switch 3 below.

REAR PANEL VIEW

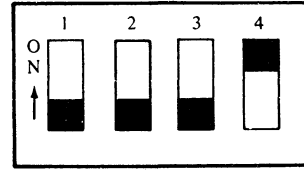

MODE/BAUD SWITCH

SETUP TABLE

MODE/BAUD SELECTION	SWITCH POSITION			
	1	2	3	4
Modes: Auto	OFF	OFF		
Draw	OFF	ON		
Point	ON	OFF		
Delta	ON	ON		
Baud Rate:				
High				
Low				
19200			OFF	OFF
1200			OFF	ON
9600			ON	OFF
600			ON	ON
4800				
300				
2400				
150				

PROGRAM SWITCH SETUP

The Program Switch located on the rear panel defines during POWER ON or RESET the modes of operation, resolution, menu internal and external operation, and output format selection. The program switch selections can subsequently be changed or externally programmed by a program input message. (See Appendix 3: Input Formats.)

REAR PANEL VIEW

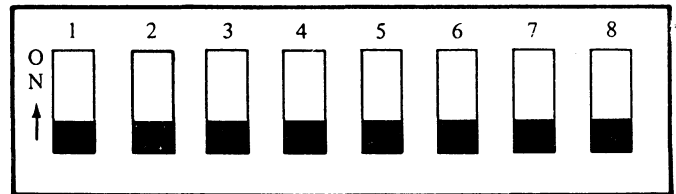

PROGRAM SWITCH

OUTPUT FORMAT: Four output formats are provided for the user. Formats 1 and 2 are binary coded and are compatible with standard industry tablets. Formats 3 and 4 provide for the additional capability of your Kurta Tablet (i.e., control menu, higher resolution, tablet size expansion) and are recommended for new designs. (See Appendix 4: Output Formats.)

BAUD RATE: Two ranges of Baud Rate are provided:

Switch 3	Baud Rates
OFF = High	19200, 9600, 4800, 2400
ON = Low	1200, 600, 300, 150

NOTE: Both Mode/Baud Switches 3 & 4 and Program Switch 3 must be set to obtain correct Baud Rate.

RESOLUTION: Two resolutions provide data output as follows:

Switch 4	8.5 x 11 Active Area	12 x 12 Active Area
OFF = 200 PPI	X = 0 to 2200 Y = 0 to 1700	X = 0 to 2400 Y = 0 to 2400
ON = 100 PPI	X = 0 to 1100 Y = 0 to 850	X = 0 to 1200 Y = 0 to 1200

(See Menu Keyboard (LO RES and HI RES) and Appendix 1: Origin Set and Resolution.)

SETUP TABLE

PROGRAM SELECTIONS	SWITCH POSITIONS							
	1	2	3	4	5	6	7	8
Output Format:								
1	OFF	OFF						
2	ON	OFF						
3	OFF	ON						
4	ON	ON						
Baud Rate:								
High			OFF					
Low			ON					
Resolution:								
200 PPI				OFF				
100 PPI				ON				
Remote Mode:								
Inactive					OFF			
Active					ON			
Internal Menu Operation:								
Active						OFF		
Inactive						ON		
External Menu Operation:								
Active							OFF	
Inactive							ON	
Origin:								
Upper Left								OFF
Lower Left								ON

HARDWARE CONFIGURATION AND SETUP (continued)

PROGRAM SWITCH SETUP (continued)

REMOTE MODE: When remote mode is inactive (Switch 5 OFF), tablet outputs data in mode selected (Auto, Draw, Point, Delta). When active (Switch 5 ON), tablet will output data only upon receipt of "DATA REQUEST" command from host.

MENU INTERNAL AND EXTERNAL OPERATIONS:

Switches 6 and 7 together control the operation of the menu keyboard. The menu keyboard may be divided into CONTROL KEYS and FUNCTION KEYS. CONTROL KEYS (AUTO through CLEAR) can change tablet operations or send a character to the Host when selected. FUNCTION KEYS (F0-F9/F11) can send only a character to the host. See MENU KEYBOARD for more detailed description and table at right for switch settings.

INTERNAL	Switch 6	OFF	OFF	ON	ON
EXTERNAL	Switch 7	OFF	ON	OFF	ON
MENU CONTROL		CHANGES OPERATION	CHANGES OPERATION	SEND MESSAGE	—
FUNCTION KEYS		SEND MESSAGE	—	SEND MESSAGE	—

The MESSAGE that will be sent by the tablet to the computer when SEND MESSAGE is listed in the MENU Operations table is indicated beneath each Key in the diagram below. X data equals Menu Key location and Y data equals zero (0). (See Appendix 4: Output Formats and Format Notes for Status.)

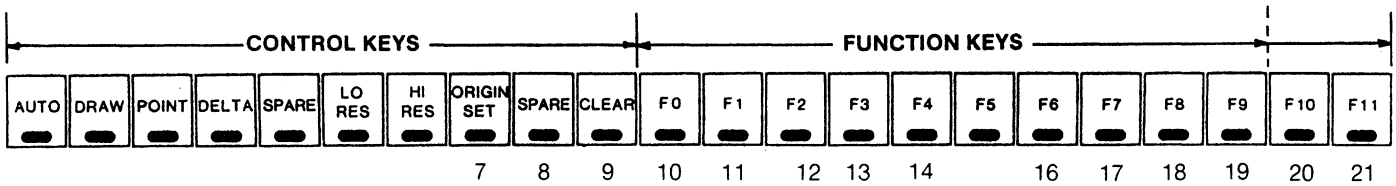

ORIGIN: Switch 8 OFF
Origin is in upper left.

Switch 8 ON
Origin is in lower left.

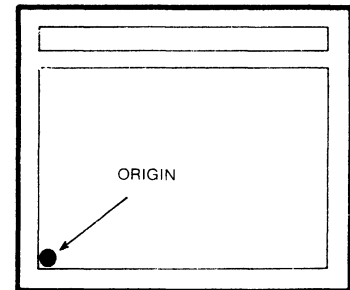
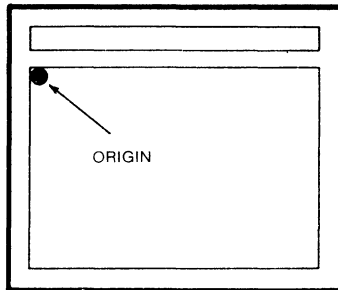

(See Menu Keyboard (Origin Set) and Appendix 1: Origin Set and Resolution.)

PEN AND CURSOR ASSEMBLIES

PEN ASSEMBLY

PEN PRESSURE AND SWITCH OPERATION: Your PEN has an internal switch housed inside the BARREL ASSEMBLY. The switch is activated when the PEN is pressed down on *any* surface; however, MENU FUNCTIONS or X, Y coordinates are transmitted only when the pen is in proximity to the MENU or WRITING SURFACE.

NOTE: *Normal writing pressure* is sufficient to fully activate the PEN SWITCH. (Press the exposed tip of the CARTRIDGE to your finger to see and feel the amount of movement and pressure required.)

Although the pen is ruggedly designed for years of use, it is still a precision instrument. Do *not* jam the switch or otherwise abuse it.

TO DISASSEMBLE: Turn PEN TIP counter-clockwise. Remove CARTRIDGE or PEN from BARREL ASSEMBLY being careful not to lose SPRING.

TO REASSEMBLE: Insert new or replacement CARTRIDGE into BARREL ASSEMBLY. Replace SPRING on CARTRIDGE. Replace PEN TIP and turn clockwise to tighten.

NOTE: The CARTRIDGE supplied with pen has no ink.

CURSOR ASSEMBLY

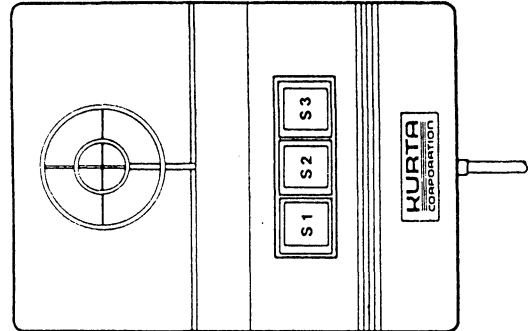

CARE AND HANDLING: Although your 3-Button Cursor is designed of durable plastic, you should exercise care while handling and cleaning it. Do not drop the Cursor or get it wet. Cleaning requires only a soft cloth lightly dampened with a non-abrasive cleaner which does not harm plastics.

NOTE: DO NOT clean the Cursor with chemicals or abrasive materials which may harm or scratch the plastic—especially the clear lens area.

CURSOR OPERATION: Your optional Cursor has precision crosshairs which allow greater accuracy in locating points to be digitized. The Cursor provides operation equivalent to the Pen when using Switch S1, and much greater capability when using the flexibility of all three switches in conjunction with Software programs.

SWITCHES: Each of the three switches is coded separately, so the switches may be used individually or in tandem giving eight (8) possible combinations. Switch S1 is identical in operation to PEN SWITCH.

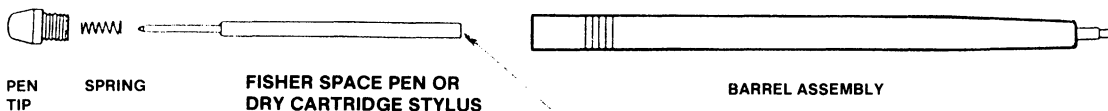

(NOTE: End surface must be kept clean and shiny.)

MENU KEYBOARD

(Internal Menu Operation - Program Switch 6 must be off.)

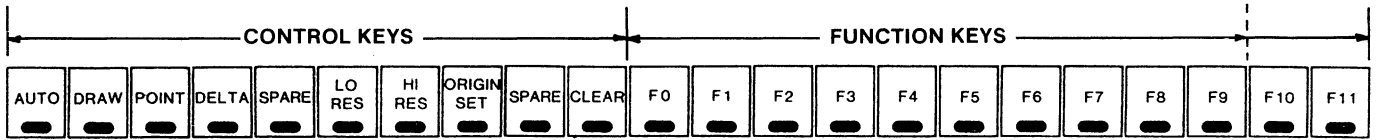

CONTROL KEYS

AUTO: Continuous data output when pen/cursor is within proximity of the active area or pen/cursor switch is activated.

DRAW: Continuous data output when writing, tracing, or drawing and pen/cursor switch is activated.

POINT: Single point data output upon each pen/cursor switch activation.

DELTA: Single data output for each 0.01 inch predefined increment of pen/cursor movement when pen/cursor switch is activated.

SPARE: Position available for user definition. Output character predefined.

LO RES: Sets resolution to $\frac{1}{2}$ of program switch resolution.

HI RES: Sets resolution to program switch resolution.

(e.g., if program switch resolution = 100: LO RES = 50, HI RES = 100; if program switch resolution = 200: LO RES = 100, HI RES = 200.)

ORIGIN SET: First pen or cursor switch activation in the surface active area after origin set selection locates the origin ($x = 0$, $y = 0$) at that point. X and y output data will increase or decrease from the new origin based on program switch origin setting (upper left, lower left) and resolution. (See Appendix 1: Origin Set and Resolution for more detail.)

SPARE: Position available for user definition. Output character predefined.

CLEAR: Resets origin to program switch origin setting (i.e., upper left, lower left).

FUNCTION KEYS

F0-F9/F11: Predefined output character sent to host. Function keys can be used with host and software to select printing or plotting operations, save or load to disk, call new programs or subroutines, request tablet setup parameters to be downloaded, etc.

OPERATION

Once the tablet has been connected to the computer and the Mode/Baud and Program Switches have been set the system is ready to operate. The following checkout procedure will confirm proper operation and provide familiarization.

Set the tablet switches as follows:

Mode/Baud Switch	
Point Mode	1 ON and 2 OFF
9600 Baud	3 OFF and 4 ON
Program Switch	
Format 1	1 OFF, 2 OFF
Baud Rates	3 OFF
Resolution 200	4 OFF
Remote mode inactive	5 OFF
Menu internal active	6 OFF
Menu external active	7 OFF
Origin lower left	8 ON

Type in the following BASIC program following the computer instruction:

```
100 DIM IN(4)
110 OPEN "COM1:9600,0,7,1" AS#1
120 I=0
130 IF EOF(1) THEN GOTO 130
140 IN(I)=ASC(INPUT$(1,#1))
150 I=I+1
160 IF I<5 THEN GOTO 130
170 S=63 AND IN(0)
180 X=64*(63 AND IN(2)) + (63 AND IN(1))
190 Y=64*(63 AND IN(4)) + (63 AND IN(3))
200 PRINT "STATUS = ";
210 PRINT USING "#";S;
220 PRINT "    X = ";
230 PRINT USING "####";X;
240 PRINT "    Y = ";
250 PRINT USING "####";Y
260 GOTO 120
```

Type RUN and depress the RETURN key. Touch the pen down in the lower left corner of the active area. The X and Y values should be approximately zero. Since the tablet is set to POINT mode, each time you touch the pen down in the active area a single data output for X and Y will occur.

Now move the pen to the right and confirm that the value of X increases each time you press the pen down. Do the same for Y. The values of X and Y should change 200 counts for each inch of movement in the X or Y direction.

NOTE: Pressing the pen down activates the pen switch which transmits the signal to the computer. Press the pen firmly but do not strike the pen tip on the surface as that action may damage both the pen and the surface.

Place the pen on the menu keyboard over the LO RES menu location. Press the pen down on the circular black area under the word LO RES. Now touch the pen down on the active area several times as you move from left to right. Confirm that the resolution is 100 points per inch.

Try to activate the pen on a surface away from the tablet, no X or Y data should appear.

Touch the pen to ORIGIN SET and then to a location in the center of the tablet. The data should be zero upon pen down and should increase in value to the right and up from this new origin location. This capability can be used to set the start point for data or the location of a paper or form. Touch CLEAR to reset the menu to its initial lower left corner position.

OPERATION (continued)

NOTE: When using DELTA, DRAW, or AUTO mode with this TEST program, the volume of tablet output data may cause a BUFFER OVERFLOW condition indicating the computer string buffer is full. If this occurs, restart the BASIC program and reduce the time you transmit data.

Touch the pen to DELTA mode. Now place the pen on the active area. The X and Y position data change only when the pen switch is activated and the pen moves 0.01 inch. If the pen switch is activated and the pen is not moved, data output will stop.

Touch the pen to DRAW mode. Now place the pen on the active area. The X and Y position data should only change when drawing on the surface. Note how the data stops when the pen pressure is removed.

Touch the pen to AUTO mode and raise the pen about two inches above the active area. Lower the pen slowly and note that data will start appearing on the screen when the pen is approximately ½ inch above the surface. No pen switch activation is required.

Spend some time learning the basic functions of the tablet and confirming proper operation. You are then ready to advance to more significant use of the tablet in operation with application software. See Appendix 1: Origin Set and Resolution.

MAINTENANCE AND SERVICE

Your Series ONE graphic tablet does not require periodic maintenance other than normal cleaning and upkeep. Make sure the writing and menu areas are clean and free of conductive material. The pen may need periodic cartridge replacement to maintain a smooth tip or provide ink capability.

TROUBLESHOOTING

If you have trouble, 1) Check all electrical connections, 2) Verify switch settings are proper for Baud rate and software program, 3) Check tablet is operational by using test program, and 4) Verify your software is operating properly.

PROBLEM	POSSIBLE CAUSE	ACTION
Power indicator does not light and/or unit does not appear to operate.	Power switch is OFF.	Turn ON.
	Power cord is not plugged into tablet.	Plug in firmly.
	Power cord is not plugged into operating power source.	Connect and check power.
Tablet is ON but there is no apparent output.	Interface cable is not plugged into computer.	Plug in firmly.
	Pen or cursor is not plugged in.	Plug in firmly.
	Pen is not in active area or pen switch is not activated.	Place pen within active area and press down firmly.
	Computer software is not operating.	Re boot software and confirm operation.
	Baud rate is not set correctly	Set Mode/Baud switch.
	Program Switch not set properly.	Check Switch settings with software instructions.
	RS232 connection may not be compatible with your computer.	See Appendix 2: RS232 Interface Connector for possible reconfiguration.
Data output appears to be intermittent or spiked.	Pen cartridge is not conducting signal.	Remove and polish top of cartridge with eraser until clean and shiny. See Pen Assembly.
	Pen tip is loose.	Tighten firmly in clockwise direction (must have spring to operate).
Data appears to be distorted or inconsistent or intermittent.	Conductive materials are being used on surface.	Do not use pencil lead, marker pen or other conductive material.
Pen will not write with Fisher Space Pen.	Supplied cartridge is a dry or inkless cartridge.	If ink is desired, replace cartridge. See Pen Assembly.
	Ink cartridge is empty	Replace as defined above.
Software Program from diskette doesn't load.	Tablet may not be on or connected properly.	Turn on tablet. If tablet is on, reset. Verify connections and switch settings have been made properly. Contact Software Dealer.
Data output is strange.	Baud rate switches may be set incorrectly.	Set Mode/Baud Switches 3 & 4 and Program Switch 3 to computer Baud rate and push RESET switch.
	Program Switch for Output Format may be set incorrectly.	See Appendix 4: Output Formats. Select proper format, set Program Switch and push RESET Switch.
Menu does not operate.	Program Switches 6 & 7 are not set properly.	See Hardware Configuration and Setup or Software Manual for proper switch settings. Set switches and push RESET switch.

SPECIFICATIONS

Performance	Resolution	Programmable to 200 points per inch
	Accuracy	+/- .025 inch
	Conversion rate	To 200 x and y coordinate pairs plus status per second (requires compatible baud rate — see Formats)
Active Area	Writing area	8.5 x 11 inches (216 x 280 mm) 12 x 12 inches (305 x 305mm)
	Menu keyboard	20 positions on 1 x 11 inch area (3 x 280 mm) 22 positions on 1 x 12 inch area (34 x 305mm)
Transducer	Pen	Equipped with dry stylus (can be replaced with Fisher Space Pen with ink)
	Cursor (option)	3 button (can be purchased at dealer)
Modes of operation	Switch selectable power on or reset (default) modes	Auto, Draw, Point, Delta and External
	Menu selectable	Auto, Draw, Point, Delta, Resolution and Origin
Interface	Serial RS232	6 foot cable equipped with DB-25S female connector
	Formats	Binary or ASCII (BCD) (switch selectable)
	Baud rate	To 19,200 Baud (switch selectable)
Microprocessor	Z8	Factory programmed
Technology	Electrostatic	Kurta proprietary design
Mechanical	Tablet with electronics	12D x 13.5W (305 x 343mm) 16D x 15W (407 x 381mm)
	Weight	5.5 lbs (2497 gm) (8.5 x 11 inch) 6.5 lbs (2951 gm) (12 x 12 inch)
Active/total area ratio	65%	
Environment	Ambient temperature	60° F to 104° F (15° C to 40° C)
	Shock and vibration	Withstands normal office or computer room operation
	Duty cycle	Continuous
Electrical	AC power	115 VAC, 50/60 Hz
Regulatory	FCC	Class B approved DMA8C9 SERIES ONE
	UL	Approved for UL114 and 478

GLOSSARY

Active Area	The 8½ x 11 (or 12 x 12) inch area of the surface that may be used for drawing.
Conversion Rate	Number or conversions of x and y coordinate data pairs plus pen/cursor status that occur per second. The output rate is dependent on the Baud rate and format selection.
Data	Numbers or counts that result from the conversion by the tablet of the pen or cursor position into corresponding digital information. The number varies from a value of zero at the origin to a maximum of 2200 (2400) in the x direction and 1700 (2400) in the y direction.
Kurta	A "message" in an old pre-biblical language, i.e. a message tablet.
Menu	Area of tablet where pressing the pen at defined surface locations is processed by the tablet or external software as a selection of alternatives.
Menu Keyboard	The 1 by 11 (12) inch area of the surface that has 20 (22) selection locations that can be used to internally control the tablet or output control messages to the host processor. Selections must be made in the lower portion of the area.
Modes of Operation	Auto, Draw, Point, Delta and External configurations of operation. (See definition of each mode in the Hardware Configuration and Setup section.)
Mouse	Little device that will bite you but has been replaced by tablet that will output all that a mouse does plus much, much more.
Origin	Place on surface where x and y position values are set to zero. Upon power up or RESET the origin is in lower left or upper left corner of the active area depending on Program Switch setting. The origin can be relocated to other positions by the origin set function on the Menu Keyboard.
Proximity	Indicates the range or distance the pen or cursor will operate above the menu keyboard or active area.
Resolution	The counts per inch or number changes that occur as the pen or cursor is moved.
Status	Output character that defines if the pen or cursor is in proximity of the surface, if the pen switch is activated, if the pen or cursor is located on the menu keyboard or active area and if any one of the cursor buttons are pushed.
Tablet	Pen or cursor, special writing area and electronics that converts position or writing into corresponding digital data that can be processed by a computer or used for other purposes.

APPENDIX 1: ORIGIN SET AND RESOLUTION

Several examples of ORIGIN and RESOLUTION are provided to assist you in understanding your tablet. Both PROGRAM SWITCHES and MENU CONTROL KEYS are changed to display the powerful capabilities of your graphics tablet. All coordinate pairs are: (X, Y). Set Mode/Baud Switch: (Point Mode, 9600 Baud). Push RESET after each SWITCH change and verify output.

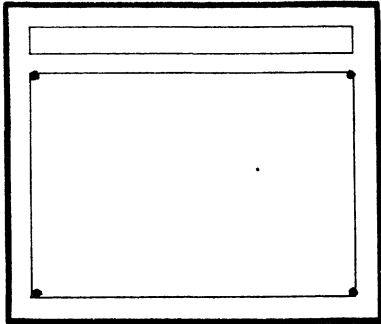
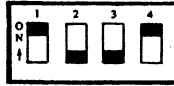

PROGRAM SWITCH

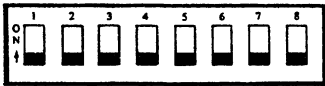

Format 1	1 OFF, 2 OFF
Baud rate	3 OFF
Resolution 200	4 OFF
Remote mode inactive	5 OFF
Menu internal active	6 OFF
Menu external active	7 OFF
Origin upper left	8 OFF

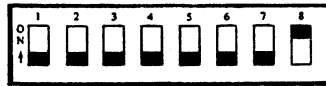
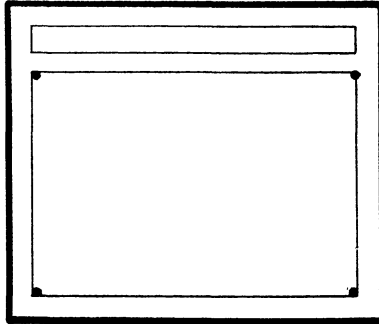

Change Switch 8 to ON.
Push RESET Switch.
Origin moves to lower left.

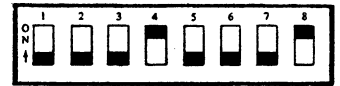
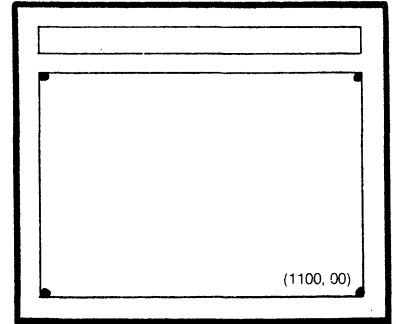

Change Switch 4 to ON.
Push RESET switch.
Resolution drops to 100 PPI.

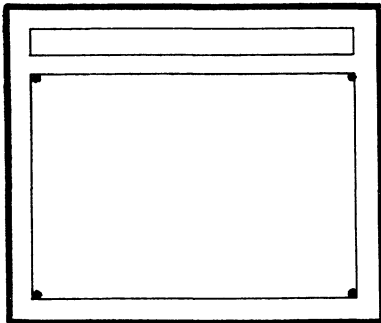

Select Control Key LO RES.
Resolution drops to 50 PPI.
Do not RESET.

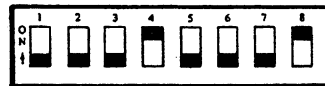
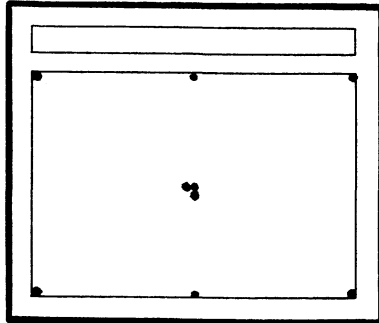

Select Control Key ORIGIN and touch Pen down in center of writing area. (X, Y coordinates are approximate.)

NOTE: X coordinates to left of Origin decrease in value from 1023. Y coordinates below Origin decrease in value from 1023. Do not RESET.

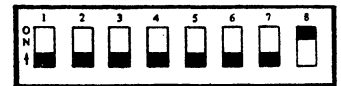
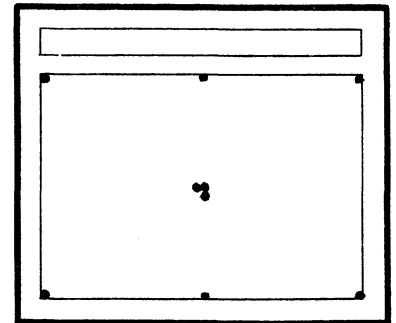

Change Switch 4 to OFF.
Push RESET Switch. Select Control Key ORIGIN and touch center.

NOTE: Tablet is 200 PPI with Origin in center.
NOTE: X and Y decrease in value from 4095 to left of and below Origin.

NOTE: All X and Y values shown are for 8.5 x 11 inch tablet.

APPENDIX 2: RS232 INTERFACE CONNECTOR

The RS232 cable that comes standard with your unit is equipped with a 25 pin female connector (Type DB-25S). This connector allows reconfiguration of the cable interface to accommodate different hardware or software requirements. The reconfiguration is made possible through the use of quick disconnect pins within the connector housing.

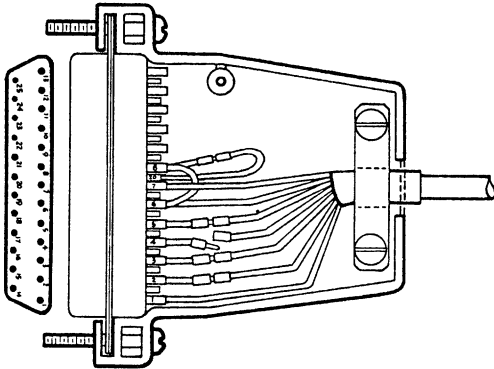

NOTE: Disconnect all power before beginning conversion.
TO DISASSEMBLE: Remove two (2) screws from connector shell by turning counterclockwise. Remove shell. Make necessary connections.
TO REASSEMBLE: Replace connector shell, insert two (2) screws and tighten by turning clockwise.

PIN #	WIRE COLOR	TABLET FUNCTION	PIN #	TYPICAL COMPUTER FUNCTION
1	Shield/Black	Ground/Return (Shield)	1	Ground
2	Brown	Receive Data In	2	Transmit Data Out
3	Red	Transmit Data Out	3	Receive Data In
4	Orange	Clear to Send (Optional)	4	Request to Send
5	Yellow	Tied to +12VDC, 300 Ohms	5	Clear to Send
6	Green	Tied to +12VDC, 300 Ohms	6	Data Set Ready
7	White	Signal Ground	7	Signal Ground
6 to 8	Buss Wire		8	Carrier Detector
	Buss Wire		20	Data Terminal Ready

NOTES:

- 1) If a male connector is required, obtain a shielded adapter from your local computer store.
- 2) The connector normally is shipped as configured above with Pin 4 disconnected because the tablet does not require Clear to Send to operate. (If Pin 4 is connected, you must have a logic one input or tablet will be inhibited.)
- 3) If your computer or software program requires the input and output channels to be reversed (consult your computer or software manual), reconfigure the connector as required using the quick disconnect pins.
- 4) The following diagrams depict some of the common configurations:

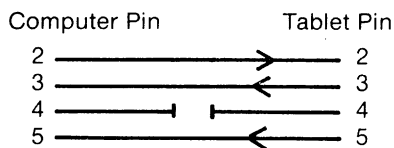

Typical Ship Configuration
Host RTS not used.

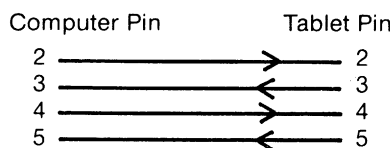

Host uses RTS to control tablet output.

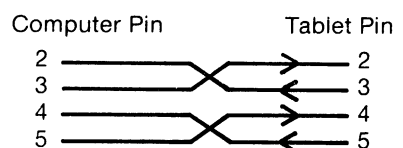

Communication channels reversed.

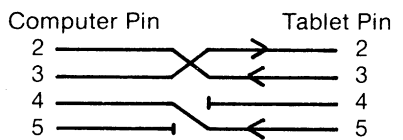

Communication channels reversed.
Host RTS not used.

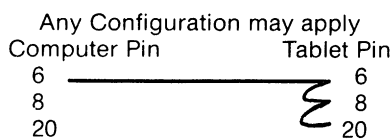

Any Configuration may apply
Computer requires Data Terminal Ready

NOTE: Pin 20 is tied high (+12VDC, 300 Ohms) to Pins 5, 6 and 8 but can be disabled if required by disconnecting the jumper.

APPENDIX 3: INPUT FORMATS

Three INPUT FORMATS have been provided for HOST or SOFTWARE control of your tablet. (Note: On INPUT FORMATS, tablet does not monitor parity bit. This allows you to use 7 data bits and odd parity or 8 data bits and no parity for your OUTPUT FORMATS.)

SINGLE CHARACTER INPUT FORMAT

CHAR.	STOP	STOP	CHARACTER BITS							START	
			B7	B6	B5	B4	B3	B2	B1	B0	
	1	1	P								0

This format may be used individually to program the tablet to 1) change MODES or RESOLUTION or SET ORIGIN or 2) set MISC CONTROL FUNCTIONS as shown in Table A. Multiple changes or controls are accompanied by sending sequential formats or as required by the program.

For example, if you wish to program tablet to DELTA mode, go to Table A and find HEX character associated with DELTA which is 43. Convert HEX to BINARY using table below.

Character bits in HEX have values as follows:

BIT VALUE (in HEX)	B6	B5	B4	B3	B2	B1	B0
4		2	1	8	4	2	1

The single character Input Format you would send in BINARY equivalent to HEX 43 is:

STOP	STOP	CHARACTER BITS							START	
		B7	B6	B5	B4	B3	B2	B1	B0	
1	1	P	1	0	0	0	0	1	1	0

(You have seven (7) character bits and parity is odd.)

PROGRAM MESSAGE INPUT FORMAT

CHAR.	STOP	STOP	CHARACTER BITS								START
			B7	B6	B5	B4	B3	B2	B1	B0	
1	1	1	P	1	0	1	0	0	0	1	0
2	1	1	P	S2-7	S2-6	S2-5	S2-4	0	S2-2	S2-1	0
3	1	1	P	0	0	0	0	S1-1	S1-2	S2-8	0

This format may be used to program the tablet to 1) change MODES and 2) change PROGRAM SWITCH functions shown in Table B. For clarity in the Input Format, Mode/Baud Switches are indicated as S1-1 and S1-2 and Program Switches are indicated as S2-1 through S2-8.

Character bits for switch settings are as follows:

OFF = 0 ON = 1

Using the PROGRAM MESSAGE INPUT FORMAT allows you to program or down load *all* switch settings for the table EXCEPT the BAUD RATE which must be manually set prior to POWER ON.

NOTE: This format programs all switch settings *except* BAUD RATE.

NOTE: PROGRAM SWITCH settings determine tablet operation on POWER ON or RESET. Each subsequent single CHARACTER or PROGRAM MESSAGE INPUT FORMAT will supercede (replace) or complement (add to) the PROGRAM SWITCH settings or INPUT FORMATS preceding it.

TABLE A

Menu Functions	Mode/Baud		Menu	ASCII	HEX
	S1	S2			
Modes					
Auto	OFF	OFF	0	@	40
Draw	OFF	ON	1	A	41
Point	ON	OFF	2	B	42
Delta (0.01 inch)	ON	ON	3	C	43
Resolution					
Fixed					
(Lo) RES			5	E	45
(Hi) RES			6	F	46
Graphic Management					
Set Origin			7	G	47
Origin Clear			9	I	49
MISC CONTROL FUNCTIONS					
Data Request				2	32
Test & Status Request				3	33
Reset	Reset (MOM)			5	35

TABLE B

Mode/Baud Switch Functions		
Modes	S1	S2
Auto	OFF	OFF
Draw	OFF	ON
Point	ON	OFF
Delta (0.01 inch)	ON	ON
Program Switch Functions		
Output Format	S1	S2
Format 1:		
Lo Res Packed Binary	OFF	OFF
Format 2:		
Hi Res Packed Binary	ON	OFF
Format 3:		
Hi Res Packed Binary	OFF	ON
Format 4:		
Hi Res ASCII (BCD)	ON	ON
Baud Rate		
High	S3	
19200, 9600, 4800, 2400	OFF	
Low		
1200, 600, 300, 150	ON	
Resolution		
200 PPI	S4	
100 PPI	OFF	
	ON	
Remote Mode		
Inactive	S5	
Active	OFF	
	ON	
Menu Internal Operation		
Active	S6	
Inactive	OFF	
	ON	
Menu External Operation		
Active	S7	
Inactive	OFF	
	ON	
Origin Location		
Upper left	S8	
Lower left	OFF	
	ON	

APPENDIX 3: INPUT FORMATS (continued)

RESOLUTION MESSAGE INPUT FORMAT

CHARACTER BITS											
CHAR.	STOP	STOP	B7	B6	B5	B4	B3	B2	B1	B0	START
1	1	1	P	1	0	1	0	0	0	0	0
2	1	1	P	X6	X5	X4	X3	X2	X1	X0	0
3	1	1	P	X13	X12	X11	X10	X9	X8	X7	0
4	1	1	P	Y6	Y5	Y4	Y3	Y2	Y1	Y0	0
5	1	1	P	Y13	Y12	Y11	Y10	Y9	Y8	Y7	0

This format allows you to define tablet resolution by defining the maximum number of counts or points in the X and Y axis, respectively. The maximum count for an 8.5 x 11 inch active area at 200 points per inch would be 2200 x 1700 points. X and Y may have a different number of points per inch. This format allows you to match the CRT pixel count, the printer or plotter capability, or program restrictions.

Character bits for X and Y are as follows:

OFF = 0 ON = 1

NOTE: You cannot exceed the maximum of 200 points per inch (X = 2200, Y = 1700 for an 8.5 x 11 inch tablet). To define resolution, 1) set maximum tablet values for X and Y, 2) put "1" in X column next to number(s) in VALUE column which add to value you wish. (See example, 128 + 512 = 640), 3) Put "0" in remaining X column blanks, 4) Do same for Y, 5) Insert character bits into format.

TABLE C

VALUE	CHARACTER BITS		EXAMPLES			
	X	Y	640	200	X	Y
1	X0	Y0	0	0		
2	X1	Y1	0	0		
4	X2	Y2	0	0		
8	X3	Y3	0	1		
16	X4	Y4	0	0		
32	X5	Y5	0	0		
64	X6	Y6	0	1		
128	X7	Y7	1	1		
256	X8	Y8	0	0		
512	X9	Y9	1	0		
1024	X10	Y10	0	0		
2048	X11	Y11	0	0		
4096	X12	Y12	0	0	0	0
8192	X13	Y13	0	0	0	0
16384	X14	Y14	0	0	0	0
32768	X15	Y15	0	0	0	0

RESOLUTION AT STANDARD SWITCH SETTINGS

SW 2-4	MENU	PPI	POINTS IN TABLET			
			8.5 X 11 Inch		12 x 12 Inch	
			X	Y	X	Y
100 PPI	LO RES	50	550	425	600	600
	HI RES	100	1100	850	1200	1200
200 PPI	LO RES	100	1100	850	1200	1200
	HI RES	200	2200	1700	2400	2400

NOTE: Maximum tablet output = 200 PPI.
X12-X15 and Y12-Y15 will = 0.

APPENDIX 4: OUTPUT FORMATS

FORMAT 1

- Lo Resolution Packed Binary Message Format out
- Five (5) characters
- To 200 points per inch resolution
- Can be used with existing systems
- B6 = synchronization bit

Character	STOP		B7	CHARACTER BITS								START
				B6	B5	B4	B3	B2	B1	B0		
1 (Status)	1	1	p	1	S4	S3	S2	S1	M	0	0	
2 (Data)	1	1	p	0	X5	X4	X3	X2	X1	X0	0	
3 (Data)	1	1	p	0	X11	X10	X9	X8	X7	X6	0	
4 (Data)	1	1	p	0	Y5	Y4	Y3	Y2	Y1	Y0	0	
5 (Data)	1	1	p	0	Y11	Y10	Y9	Y8	Y7	Y6	0	

FORMAT 2

- Hi Resolution Packed Binary Message Format out
- Six (6) characters
- To 200 points per inch resolution
- Can be used with existing systems
- B7 = synchronization bit

Character	STOP		B7	CHARACTER BITS								START
				B6	B5	B4	B3	B2	B1	B0		
1 (Status/Data)	1	1	1	M	S4	S3	S2	S1	X15	X14	0	
2 (Data)	1	1	0	X13	X12	X11	X10	X9	X8	X7	0	
3 (Data)	1	1	0	X6	X5	X4	X3	X2	X1	X0	0	
4 (Data)	1	1	0	0	0	0	0	0	Y15	Y14	0	
5 (Data)	1	1	0	Y13	Y12	Y11	Y10	Y9	Y8	Y6	0	
6 (Data)	1	1	0	Y6	Y5	Y4	Y3	Y2	Y1	Y0	0	

FORMAT 3

- Hi Resolution Binary Message Format Out
- Five (5) characters
- To 200 points per inch resolution
- Full MENUS use for new systems
- B7 = synchronization bit

Character	STOP		B7	CHARACTER BITS								START
				B6	B5	B4	B3	B2	B1	B0		
1 (Status)	1	1	1	0	0	M	S4	S3	S2	S1	0	
2 (Data)	1	1	0	X6	X5	X4	X3	X2	X1	X0	0	
3 (Data)	1	1	0	X13	X12	X11	X10	X9	X8	X7	0	
4 (Data)	1	1	0	Y6	Y5	Y4	Y3	Y2	Y1	Y0	0	
5 (Data)	1	1	0	Y13	Y12	Y11	Y10	Y9	Y8	Y7	0	

FORMAT 4

- ASCII Message Format Out
- Ten (10) characters
- To 200 points per inch resolution
- Full MENU use for new systems

Character	STOP		B7	CHARACTER BITS								START
				B6	B5	B4	B3	B2	B1	B0		
1 (Status)	1	1	p	A3	A2	A1	S4	S3	S2	S1	0	
2 (Data)	1	1	p	0	1	1	X15	X14	X13	X12	0	
3 (Data)	1	1	p	0	1	1	X11	X10	X9	X8	0	
4 (Data)	1	1	p	0	1	1	X7	X6	X5	X4	0	
5 (Data)	1	1	p	0	1	1	X3	X2	X1	X0	0	
6 (Data)	1	1	p	0	1	1	Y15	Y14	Y13	Y12	0	
7 (Data)	1	1	p	0	1	1	Y11	Y10	Y9	Y8	0	
8 (Data)	1	1	p	0	1	1	Y7	Y6	Y5	Y4	0	
9 (Data)	1	1	p	0	1	1	Y3	Y2	Y1	Y0	0	
10 (CR)	1	1	p	0	0	0	1	1	0	1	0	

FORMAT NOTES:

- X = X (left and right) data bits., X0 = LSB
- Y = Y (up and down) data bits., Y0 = LSB
- P = Odd parity (if available)
- M = Menu (if 0 = data output;
if 1 = menu output: x = menu location,
y = 0. See internal/external menu.)
- S1 = When pen or cursor switch No. 1 is activated, S1 = 1 (otherwise S1 = 0)
- S2-S4 = Cursor switch No. 2-4 are activated,
S2-S4 = 1 respectively (otherwise S2-S4 = 0).
- CR = Carriage Return

- A3 A2 A1 = Pen/Cursor location and switch status
- 0 1 0 = No switch activation
- 0 1 1 = Switch activation in writing area
- 1 0 0 = Switch activation in menu area

APPENDIX 5: MENUCODER

MENUCODER is a BASIC program which provides an interface between your Kurta tablet and a menu application program.

MENUCODER allows the user to define the menu array and the numeric output for each menu block. The numeric output from the menu block would be used as input to the application program.

Standard menu arrays can be developed by following a few simple rules. Each block must be a multiple of $\frac{1}{4}$ inch blocks (smallest block would be $\frac{1}{4}$ " x $\frac{1}{4}$ "), rectangular in shape, and numbered from left to right and top to bottom. A single data statement is sufficient for this example: DATA 01, 01, 01, 01, 44, 34, 1. (See program lines 1050-1210 and Example 1.)

NOTE:

- 01: First menu block (X-axis) starts on left edge if positive.
- 01: First menu block (Y-axis) starts on top edge if positive.
- 01: Each menu block is $\frac{1}{4}$ inch high in X-axis.
- 01: Each menu block is $\frac{1}{4}$ inch wide in Y-axis.
- 44: There are 44 menu blocks in a row.
- 34: There are 34 menu blocks in a column.
- 01: First menu block (top left hand corner) is number 1
(First menu block in row 2 will be 45 and last menu block in lower right corner will be 1496.)

To change this example to a menu array of $1 \times \frac{1}{2}$ inch blocks, the data statement would be: DATA 01, 01, 04, 02, 11, 17, 01. (See Example 2.)

MENUCODER will accommodate various sizes of menu blocks, blank areas, and number output schemes within one menu array. PROGRAM LINES 1230-1280 are an example of a border of $\frac{1}{2} \times \frac{1}{2}$ inch menu blocks around the edge of the active area. The menu blocks are numbered sequentially from 1 to 74 in a clockwise manner. (See Example 3.)

NOTE: A separate DATA statement is required: 1) For each rectangular grouping of contiguous same size menu blocks, and 2) each time you change from 'left to right' to 'right to left,' or from 'top to bottom' to 'bottom to top' numbering sequence.

MENUCODER also allows you to include up to 49 separate menu arrays or SCREENS in your program. The data format for each SCREEN is:

- DATA 50: SCREENS have DATA statement numbers ranging from 50 to 98.
- DATA : Define menu array.
- DATA 99: SCREEN terminator. Each individual SCREEN definition must end with DATA 99.

PROGRAM LINE 1330 defines the SCREEN number for the program to call. SCREEN 50 in the DATA statements equals 0 in program line 1330; SCREEN 51 equals 01; and SCREEN 98 equals 48. You may want to change this to an input field.

MENUCODER numeric output is printed to the computer screen in Program Line 1400. This would be the place to tie in your application program requiring menu output.

Example 1

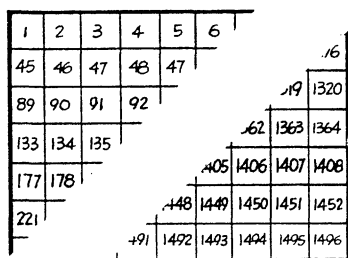

$\frac{1}{4} \times \frac{1}{4}$ inch blocks
Data 01, 01, 01, 01, 44, 34, 1

Example 2

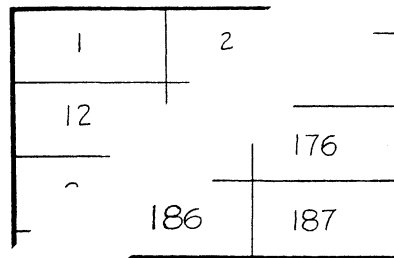

$1 \times \frac{1}{2}$ inch blocks
Data 01, 01, 04, 02, 11, 17, 01

Example 3

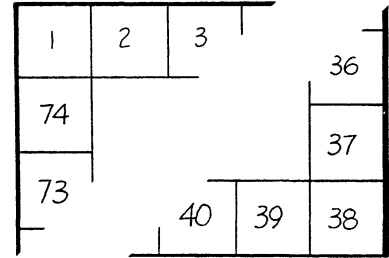

$\frac{1}{2} \times \frac{1}{2}$ inch blocks
See Program Lines 1240-1270

MENCODER (continued)

Program Lines	Description
1000 - 1040	Defines tablet size and counts per block
1050 - 1220	Defines setup parameters for menu array
1230 - 1290	Example for menu that forms border of 1/2" blocks around (active area)
1300 - 1320	Establishes communications between BASIC program and tablet.
1330 - 1340	Unpacks parameters for designated SCREEN (menu array)
1390 - 1410	Sample output from tablet interface to user application program. MENCODER currently outputs: MENU (menu number), X (X coordinate), Y (Y coordinate)

```

1000 DEFINT M
1010 DIM MENU(43,33),I(4)
1020 X25=50 ' COUNTS/.25 IN (11 IN=2200)
1030 Y25=50 ' COUNTS/.25 IN (8.5 IN=1700)
1040 '
1050 ' THE MENU BLOCKS ARE CREATED BY A SET OF PARAMETERS. ONE ENTRY
1060 ' DEFINES ANY SET OF SIMILAR SPACE WISE CONTIGUOUS BLOCKS. EACH
1070 ' ENTRY IS AS FOLLOWS:
1080 '
1090 ' STARTING X / SCREEN NUMBER / TERMINATOR
1100 ' 1-44 STARTING X - .25 IN/COUNT
1110 ' - LEFT END IF POSITIVE 'BLOCK SIZE X'
1120 ' 50-98 SCREEN NUMBER (BEGINNING) - 00-48
1130 ' 99 TERMINATOR
1140 ' STARTING Y 1-34 - .25 IN/COUNT
1150 ' - TOP IS POSITIVE 'BLOCK SIZE Y'
1160 ' BLOCK SIZE X 1-44 - .25 IN/COUNT
1170 ' BLOCK SIZE Y 1-34 - .25 IN/COUNT
1180 ' NR BLOCKS X 1-44
1190 ' NR BLOCKS Y 1-34
1200 ' STARTING NR 1-65535 - LEFT TO RIGHT (POSITIVE 'BLOCK SIZE X')
1210 ' TOP TO BOTTOM (POSITIVE 'BLOCK SIZE Y')
1220 '
1230 DATA 50: ' SCREEN NR 00
1240 DATA 01,01,02,02,22,01,01: ' 01-22 LEFT TO RIGHT BORDER (TOP)
1250 DATA 43,03,02,02,01,15,23: ' 23-37 TOP TO BOTTOM BORDER (RIGHT)
1260 DATA 44,34,-2,-2,22,01,38: ' 38-59 RIGHT TO LEFT BORDER (BOTTOM)
1270 DATA 01,32,02,-2,01,15,60: ' 60-74 BOTTOM TO TOP BORDER (LEFT)
1280 DATA 99: ' TERMINATOR
1290 '
1300 ' OPEN COMM FILE AND UNPACK FORMAT
1310 '
1320 OPEN "COM1:9600,0,7,1" AS#1
1330 SCRN=0
1340 GOSUB 1700
1350 PRINT "READY FOR COMMUNICATIONS"
1360 '
1370 ' INPUT A POINT FROM THE TABLET AND DISPLAY ON THE CRT
1380 '
1390 GOSUB 1500
1400 PRINT "MENU ";MENUNR;" X ";X;" Y ";Y
1410 GOTO 1390
1420 '
1430 ' GET A POINT AND CHECK IF A MENU BLOCK
1440 '
1450 ' RET: 'MENUNR' <> 0 MENU BLOCK NR
1460 ' = 0 POINT NOT IN MENU BLOCK
1470 ' 'X' X COORDINATE
1480 ' 'Y' Y COORDINATE
1490 '
1500 I=0
1510 IF EOF(1) THEN GOTO 1510
1520 IN(I)=ASC(INPUT$(1,#1))
1530 I=I+1
1540 IF I<5 THEN GOTO 1510
1550 X=64*(63 AND IN(2)) + (63 AND IN(1))
1560 Y=64*(63 AND IN(4)) + (63 AND IN(3))
1570 WX=INT(X/X25)
1580 WY=INT(Y/Y25)
1590 MENUNR=MENU(WX,WY)
1600 RETURN
1610 '
1620 ' SET UP THE MENU BLOCK AREA
1630 '

```

```

1640 ' ENT: SCREEN SCREEN NUMBER (00-48)
1650 '
1660 ' RTN: MENU(X,Y) SET-UP FOR CURRENT SCREEN
1670 ' F O=SCREEN NUMBER NOT VAILD
1680 ' 1=SCREEN PARAMETERS UNPACKED
1690 '
1700 IF IPARM=0 THEN GOTO 1740
1710 FOR X=0 TO 43
1720 FOR Y=0 TO 33:MENU(X,Y)=0:NEXT Y
1730 NEXT X
1740 IPARM=1
1750 F=0
1760 RESTORE
1770 READ X
1780 IF X=99 THEN RETURN
1790 IF X>49 THEN IF SCRNUM=50 = X THEN GOTO 1860
1800 IF X>49 THEN GOTO 1770
1810 READ Y,BX,BY,NRX,NRY,NR
1820 GOTO 1770
1830 '
1840 ' FOUND SCREEN NR, READ PARAMETERS
1850 '
1860 READ X
1870 IF X=99 THEN F=1:RETURN
1880 IF X>49 THEN F=1:RETURN
1890 READ Y,BX,BY,NRX,NRY,NR
1900 X=X-1:Y=Y-1
1910 WX=X:WY=Y:WBX=BX:WBY=BY:WNRX=NRX:WNR=NR:WNRN=NR
1920 MENU(WX,WY)=WNR
1930 IF WBX > 0 THEN WX=WX-1:WBX=WBX-1
1940 IF WBX < 0 THEN WX=WX+1:WBX=WBX+1
1950 IF WBX <> 0 THEN GOTO 1920
1960 WBX=BX
1970 WNR=WNR+1
1980 WNRX=WNRX-1
1990 IF WNRX <> 0 THEN GOTO 1920
2000 WNRX=NRX
2010 IF WBY > 0 THEN WY=WY-1
2020 IF WBY < 0 THEN WY=WY+1
2030 IF WBY > 0 THEN WBY=WBY-1
2040 IF WBY < 0 THEN WBY=WBY+1
2050 IF WBY <> 0 THEN WNR=NR:WX=X:GOTO 1920
2060 WY=WY+WBX
2070 WBY=BY
2080 NR=NR+NRX
2090 WNRN=WNRN-1
2100 IF WNRN <> 0 THEN WNR=NR:WX=X:GOTO 1920
2110 GOTO 1860
2120 RETURN

```

KURTA

CORPORATION

4610 South 35th Street
Phoenix, Arizona 85040

CUSTOMER PRODUCT COMMENTS

Your suggestions and comments about our graphic tablets, digitizer products, and any software you may use with these services help us improve our products. Kurta may use and distribute any information you provide in any manner it deems appropriate without incurring any obligation. You may, of course, continue using the information you supply. Please include your name and address and any other pertinent information in the space provided:

COMMENTS:

Name _____ Position Title _____ Date _____

Address _____

City/State/Zip _____ Phone _____

Serial #: _____

Where purchased: _____

USE: Business Graphics CADD CAE CAM MENUING PROFESSIONAL HOME

Other Please specify _____

Software Used: _____

Hardware Used: _____

KURTA

CORPORATION

KURTA CORPORATION
4610 South 35th Street
Phoenix, Arizona 85040
Copyright © 1984