

## HP 98626A RS-232 Interface Installation

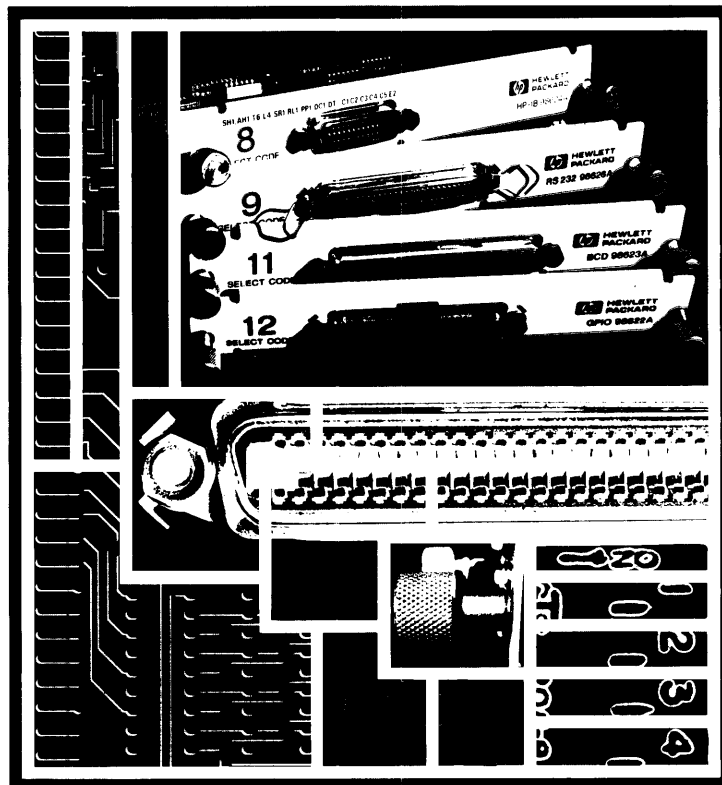

# **HP 98626A RS-232C Interface Installation**

Manual Part No. 98626-90000

© Copyright Hewlett-Packard Company, 1982

This document refers to proprietary computer software which is protected by copyright. All rights are reserved. Copying or other reproduction of this program except for archival purposes is prohibited without the prior written consent of Hewlett-Packard Company.

**Hewlett-Packard Company**  
Roseville Networks Division  
8000 Foothills Boulevard  
Roseville, California 95678

## Printing History

New editions of this manual will incorporate all material updated since the previous edition. Update packages may be issued between editions and contain replacement and additional pages to be merged into the manual by the user. Each updated page will be indicated by a revision date at the bottom of the page. A vertical bar in the margin indicates the changes on each page. Note that pages which are rearranged due to changes on a previous page are not considered revised.

The manual printing date and part number indicate its current edition. The printing date changes when a new edition is printed. (Minor corrections and updates which are incorporated at reprint do not cause the date to change.) The manual part number changes when extensive technical changes are incorporated.

June 1981...First Edition Installation Note

August 1981...Second Edition Installation Manual

May 1982...Third Edition. Updated pages: ii, iii, iv, 2-1 thru 2-5. Added pages: Appendix C-1 thru C-4.

---

### NOTICE

The information contained in this document is subject to change without notice.

HEWLETT-PACKARD MAKES NO WARRANTY OF ANY KIND WITH REGARD TO THIS MATERIAL, INCLUDING, BUT NOT LIMITED TO, THE IMPLIED WARRANTIES OF MERCHANTABILITY AND FITNESS FOR A PARTICULAR PURPOSE. Hewlett-Packard shall not be liable for errors contained herein or for incidental or consequential damages in connection with the furnishing, performance or use of this material.

Hewlett-Packard assumes no responsibility for the use or reliability of its software on equipment that is not furnished by Hewlett-Packard.

This document contains proprietary information which is protected by copyright. All rights are reserved. No part of this document may be photocopied, reproduced or translated to another program language without the prior written consent of Hewlett-Packard Company.

# Table of Contents

## Chapter 1: General Information

Introduction .....	1-1
Background on Data Communications .....	1-2
RS-232C .....	1-3
Specifications .....	1-3
Environmental .....	1-3
Electrical .....	1-3
Cable Options .....	1-4

## Chapter 2: Installation

Unpacking and Inspection .....	2-1
Conditions Set by User .....	1-2
Configuring the Interface .....	2-2
Installing Interface Cards in the Backplane .....	2-6

## Appendix A: RS-232C

RS-232C Compatible .....	A-1
What is RS-232C? .....	A-1
Mechanical Characteristics .....	A-2
Electrical Characteristics .....	A-2

## Appendix B: RS-232C Function Table

## Appendix C: Replaceable Parts

### Figures

1-1 Modem Conversion Process .....	1-1
1-2 Asynchronous Mode Transmission .....	1-1
1-3 Using the 98626 Option 001 Cable .....	1-4
1-4 Using the 98626 Option 002 Cable .....	1-5
1-5 Point-to-Point System .....	1-5
1-6 Typical Data Communications System with Modems .....	1-6
2-1 Select Code Switch and Baud Rate Switch Settings .....	2-2
2-2 Interrupt Level Switch Settings .....	2-3
2-3 Line Control Switch Settings .....	2-3
2-4 Status Line Disconnect Switch Settings and Remote Keyboard Jumper .....	2-4
2-5 Installing the Interface Card in the Computer .....	2-6
A-1 25-Pin Connector .....	A-2
A-2 Interchange Equivalent Circuit .....	A-3
A-3 Circuit Voltage Levels .....	A-3

**Tables**

1-1	Cable Options .....	1-4
2-1	Conditions Set by User .....	2-1
2-2	Cable Signals .....	2-7
2-3	Connector Wiring .....	2-8
C-1	Replaceable Parts .....	C-2

# Chapter 1

## General Information

### Introduction

This manual describes the installation of the HP 98626A RS-232C Interface. This interface provides serial data communication between the 9826 computer and a data communications device. This chapter contains a background on data communications, a description of the RS-232C standard, a description of the 9826 implementation of the RS-232C standard, specifications, options and cable functions. Chapter 2 contains installation information.

The HP 98626A RS232C Interface enables the 9826 computer to communicate with serial asynchronous data communications devices. Data can be transferred at standard baud rates of 50 to 9,600. A universal asynchronous receiver/transmitter integrated circuit (UART) is used to manipulate data and provide the basic hardware protocol for asynchronous operation. The interface is available in cable configurations which enable the 9826 computer to act as either a data terminal or the digital portion of a modem. For specialized applications, the 98626 interface supports the HP 13265A 300 Baud Modem and the HP 13266B Current-loop Interface.

The HP 98628 Data Communications Interface is also a serial data interface. It provides communication to RS-449/422-A and RS-449/423-A devices as well as RS-232 devices. It supports enhanced asynchronous protocol and HP Data Link protocol. Enhancements include half- and full-duplex software handshake and I/O timeout. For specialized applications, the 98628 interface supports the HP 13264A Data Link Adaptor, the HP 13265A 300 Baud Modem and the HP 13266B Current-loop Interface.

## Background on Data Communications

Data Comm is the means by which data is transmitted from one point to another. A computer can be hooked directly to a remote terminal using special transmission lines, but for long distances, this becomes impractical. Although common telephone lines can be used, there is one drawback: telephone lines are made for analog signals (e.g., the voice), not digital signals like those generated by a computer. A modem, or a signal converter, must be used for converting signals from digital to analog and vice versa. A modem is a contraction of the words modulator and demodulator.

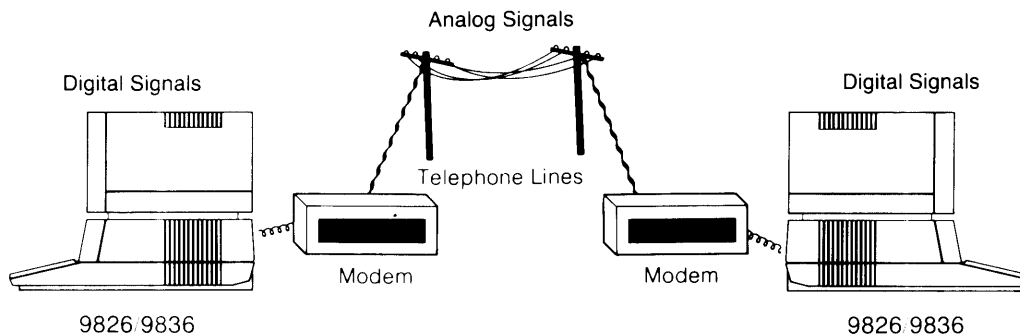

Figure 1-1. Modem Conversion Process

The modem converts outgoing digital signals to analog form and incoming analog signals to digital form (Figure 1-1). Since there are many different ways to do these conversions, it is important that data converted to analog is re-converted to the correct digital form. So, the modem on one end of the telephone line must understand, or be compatible with, the modem on the other end.

Modems are classified as synchronous or asynchronous, by mode, by data rate and by modulation technique.

Asynchronous transmission is often referred to as START-STOP. This is because the data is sent serially one character at a time along with start and stop bits. These start and stop bits are used to separate characters and to synchronize the receiver with the transmitter for each character since the modem itself does not provide clocking information. When the signal elements or bits of a character travel in sequence over the line, it is called a serial transmission. With the start and stop bits added, this is called serial start-stop or serial asynchronous, meaning each character is individually synchronized. This type of transmission is normally used at data rates up to 2,400 bits per second.

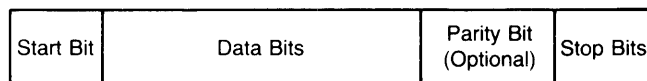

Figure 1-2. Asynchronous Mode Transmission

Modems can operate in three different modes:

- Simplex, where data is sent only or received only,
- Half-duplex, where data can be both sent and received, but not simultaneously,
- Full-duplex, where data can be simultaneously transmitted and received.

Half-duplex is normally used for high-speed batch transmission where fewer line turn-arounds are needed and full channel capacity (bandwidth) is needed for transmission in one direction. Full-duplex is often used for timesharing, even though it seldom occurs that data is truly being transmitted and received simultaneously. The one case where simultaneous transmission does occur is when a break'' is sent to the timeshare computer. One reason for full-duplex timesharing is to provide transmission error checking by having the computer echo'' or re-transmit each character input from the terminal.

The most commonly referenced operational characteristic of a modem is its speed or data rate expressed in bits per second (bps) or baud. For simple low-speed modulation techniques, one bit per second into a modem may equal one baud on the analog side. However, at higher data rates with more complex modulation techniques, it is possible to encode more than one bit per signal change (or baud) on the telephone line. In this case, bits per second (into the modem) and baud (on the telephone line) are two different units.

## RS-232C

One of the standards adopted by the EIA for use with data communications was the Electronic Industries Association RS-232C, Interface Between Data Terminal Equipment and Data Communications Equipment Employing Serial Binary Data Interchange. The RS-232C is the most common data communications protocol in use today. The International Telegraph and Telephone Consultative Committee, or CCITT, Standards V.24 and V.28, parallel the EIA RS-232C and provide a compatible international standard. RS-232C has been the most successful interfacing standard implemented to date.

A lengthy description of the RS-232C standard is contained in Appendix A. Appendix B contains a table of RS-232C functions, listed by pin number.

## Specifications

### Environmental

Generally speaking, any environment in which an HP computer can operate is also acceptable for the 98626 Serial Interface. If extreme environmental conditions exist, or if there is a question about specifications not listed here, consult your local HP sales and service office.

### Electrical

The 98626 is designed to conform to the RS-232C standard. A discussion of the RS-232C standard is contained in Appendix A.



## Cable Options

The 98626 interface comes with a choice of two cables. The option number determines which cable is provided with the interface. Table 1-1 describes which equipment is included with the available options.

**Table 1-1. Cable Options**

Option	Connector	Purpose
001	25 pin male	Computer to modem or other data comm equipment
002	25 pin female	Computer to data terminal equipment

The 98626 option 001 interface cable is shipped with a 4.9 metre (16 ft) cable terminated with a standard male EIA 25-pin connector. The option 001 interface is connected between the computer and a modem.

Using the option 001 interface cable, the computer acts as a data terminal connected to a modem.

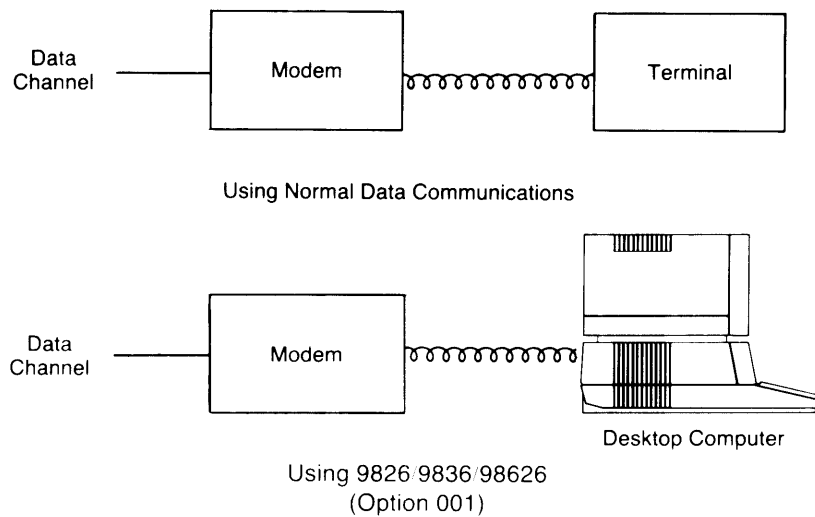

**Figure 1-3. Using the 98626 (option 001) Cable**

The 98626 option 002 interface is shipped with a 4.9 metre (16 ft) cable terminated with a standard female EIA 25 pin connector. The option 002 interface is connected between the computer and a data terminal.

Using the option 002 interface cable, the computer takes the place of a modem or computer communicating with a terminal.

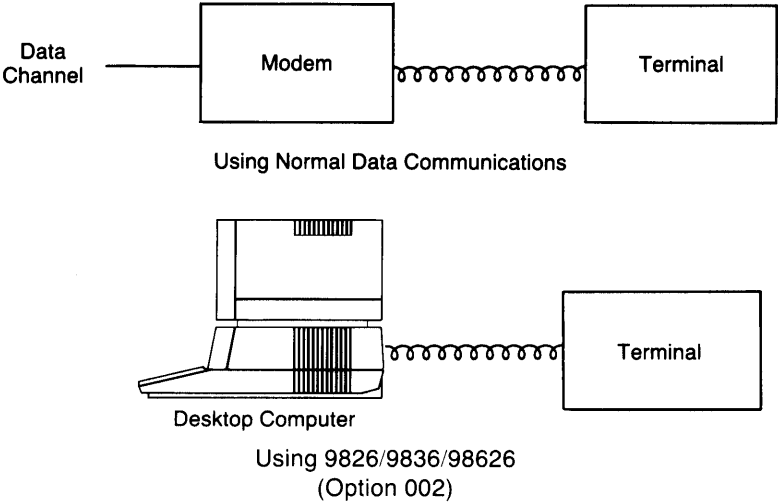

Figure 1-4. Using the 98626 Option 002 Cable

Figure 1-5 shows a typical point-to-point installation using the 98626 interface. Note that one computer uses the option 001 connector, while the other is using option 002.

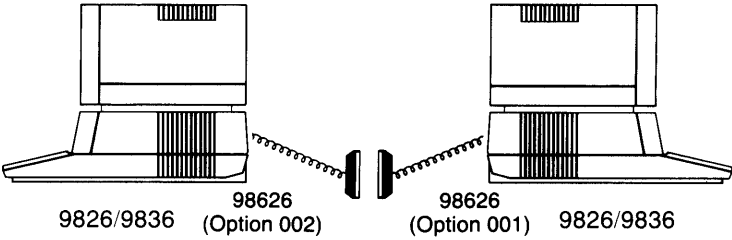

Figure 1-5. Point-to-Point System

Figure 1-6 shows a typical installation using modems to convey information over commercial telephone lines. Both computers in this example use the option 001 connector.

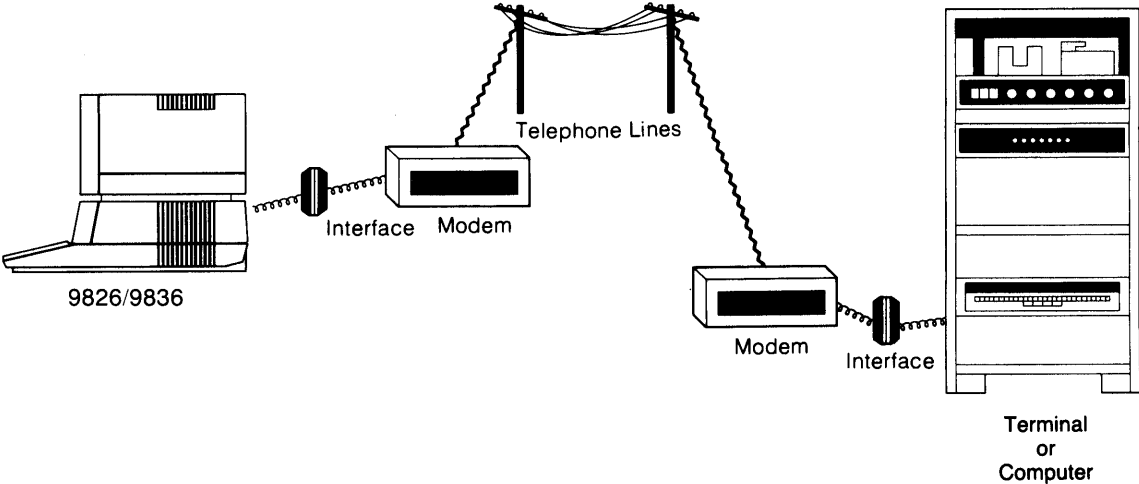

Figure 1-6. Typical Data Communications System With Modems

## 1-6 General Information

# Chapter 2

## Installation

### Unpacking and Inspection

If the shipping carton is damaged, ask the carrier's agent to be present when the interface is unpacked. If the interface is damaged or fails to meet electrical specifications, immediately notify the carrier and the nearest HP sales and service office. Retain the shipping carton for the carrier's inspection. The sales and service office will arrange for the repair or replacement of your interface without waiting for the claim against the carrier to be settled.

### Conditions Set by User

Many conditions are determined by the position of switches or jumpers set by the user. Table 2-1 contains a list of these conditions, the choices allowed by the switches and jumpers and the factory settings of each.

**Table 2-1. Conditions Set by User**

Function	Choices	Factory Setting
Select code	Five switches allow choice of 32 codes	9 (01001)
Baud rate	Four switches select one of 16 baud rates	<b>2400 (1010)</b>
Character word length	Two switches select among 5-, 6-, 7- or 8-bit word length	8 (11)
Number of stop bits	One switch chooses one or two stop bits	1 (0)
Parity enable	One switch to enable parity	Disable (0)
Parity select	Select odd or even parity	Odd (0)
Parity stick	One switch to make parity bit always 0 or always 1, according to Parity Select Switch	No (0)
Interrupt level	Two switches select interrupt level 3, 4, 5 or 6	3 (00)
Status line disconnect switches	Four switches disconnect and tie high unused status lines	Disconnected
Remote keyboard	Jumper selects between 9826 keyboard and a remote keyboard	Local (jumper installed)

Note that all of these switches except Interrupt Level, Status Line Disconnect and Select Code may be overridden by software, once the interface is in operation.

## Configuring the Interface

As noted above, many interface functions are selected by switches or a jumper wire. This section contains instructions for verifying or changing the selections.

The switches used may be either slide or recessed rocker switches. Both types are illustrated in the factory preset positions.

**CAUTION**

IF YOU CHANGE ANY OF THE FACTORY SETTINGS, MAKE SURE THAT YOU CHANGE THE PROPER SWITCH SEGMENTS. DO NOT DISTURB THE SETTINGS OF ADJOINING SWITCHES. USE A PENCIL POINT OR SIMILAR OBJECT FOR CHANGING SWITCH SETTINGS.

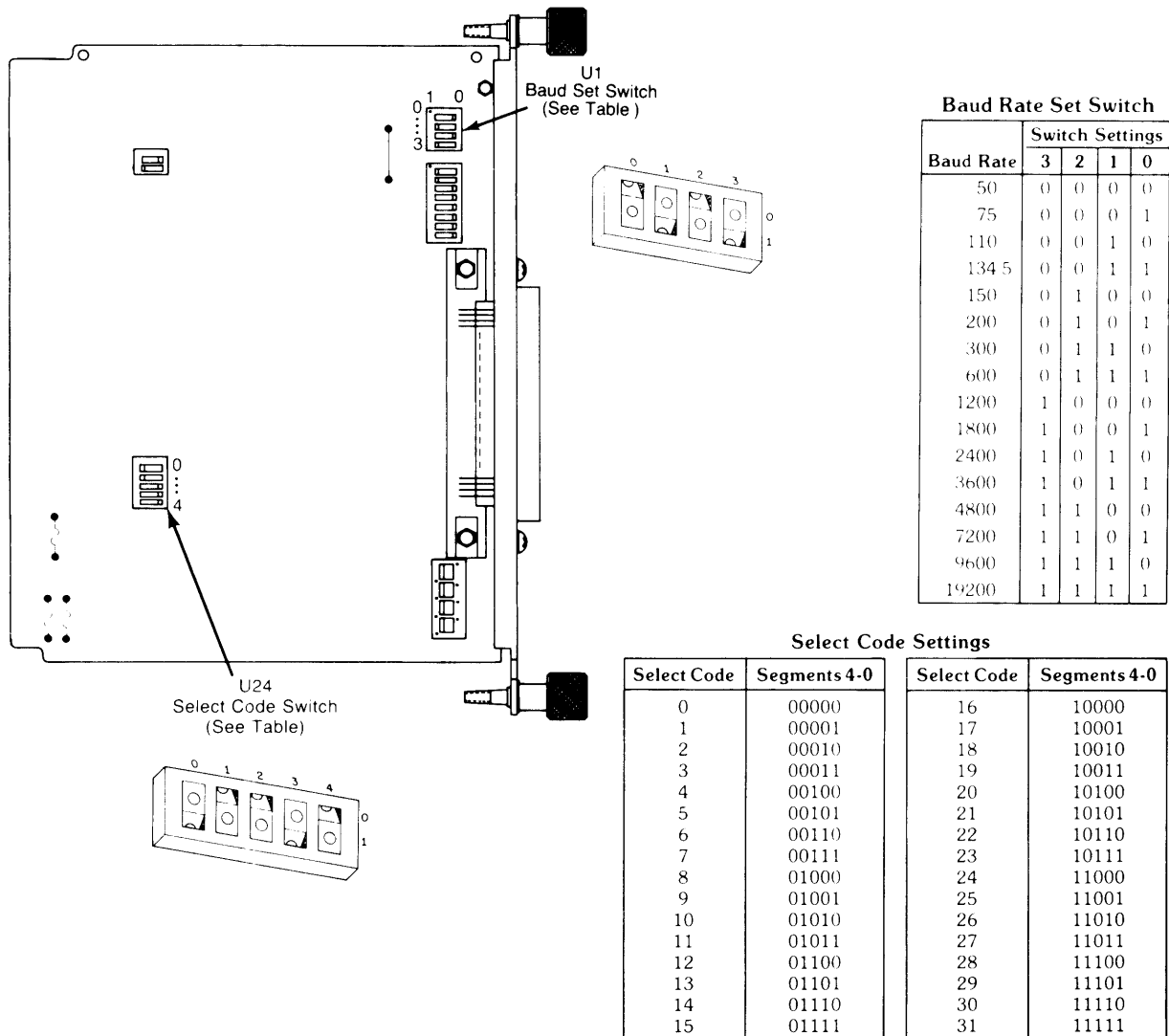

Figure 2-1. Select Code Switch and Baud Rate Switch Settings

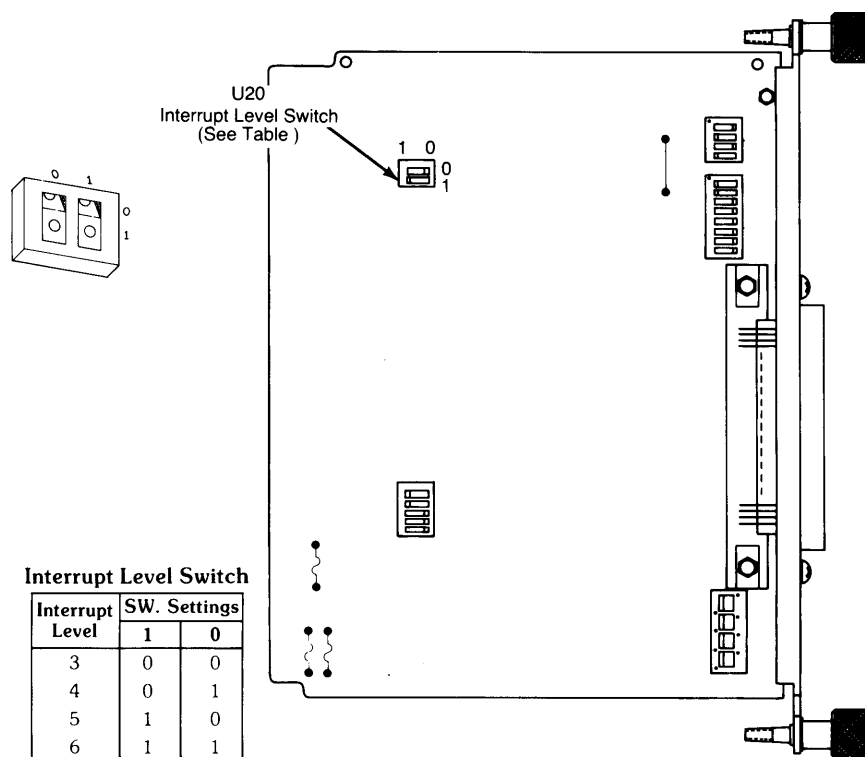
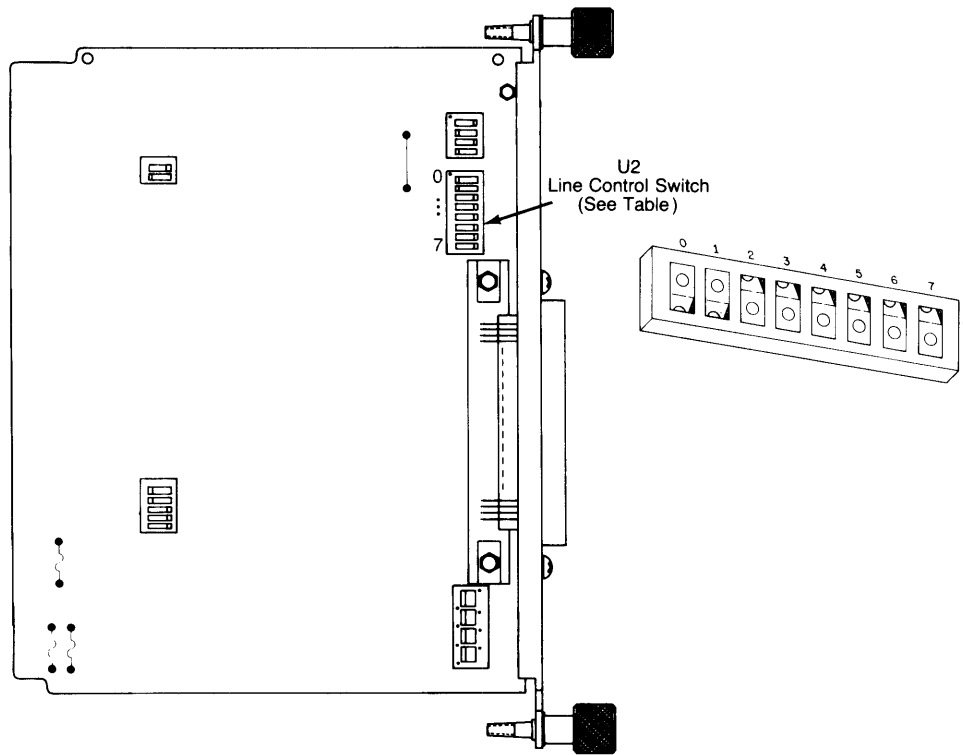

Figure 2-2. Interrupt Level Switch Settings

2-4 Installation



Line Control Switch Setting

Bit 0	Bit 1	Bit 2	Bit 3	Bit 4	Bit 5	Bit 6	Bit 7
Character Length		Stop	Parity Enabled	Parity Type		Handshake Type	
0 = 5 Bits/Char	0	0 = Stop Bit Added	Parity Enable Generation and Checking	0 = Odd	0	Don't Care	Don't Care
1 = 6 Bits Char	0	1 = 1.5 Stop Bits @ 5 Bits/Char		1 = Even	0		
0 = 7 Bits/Char	1	1 = 2.0 Stop Bits @ 6, 7 or 8 Bits/Char	1 = Enabled	0 = Parity Bit = 1	1	Reserved For Future Use	Reserved For Future Use
1 = 8 Bits/Char	1			1 = Parity Bit = 0	1		

Character Word Length Settings      Stop Bit Settings      Parity Settings

Figure 2-3. Line Control Switch Settings

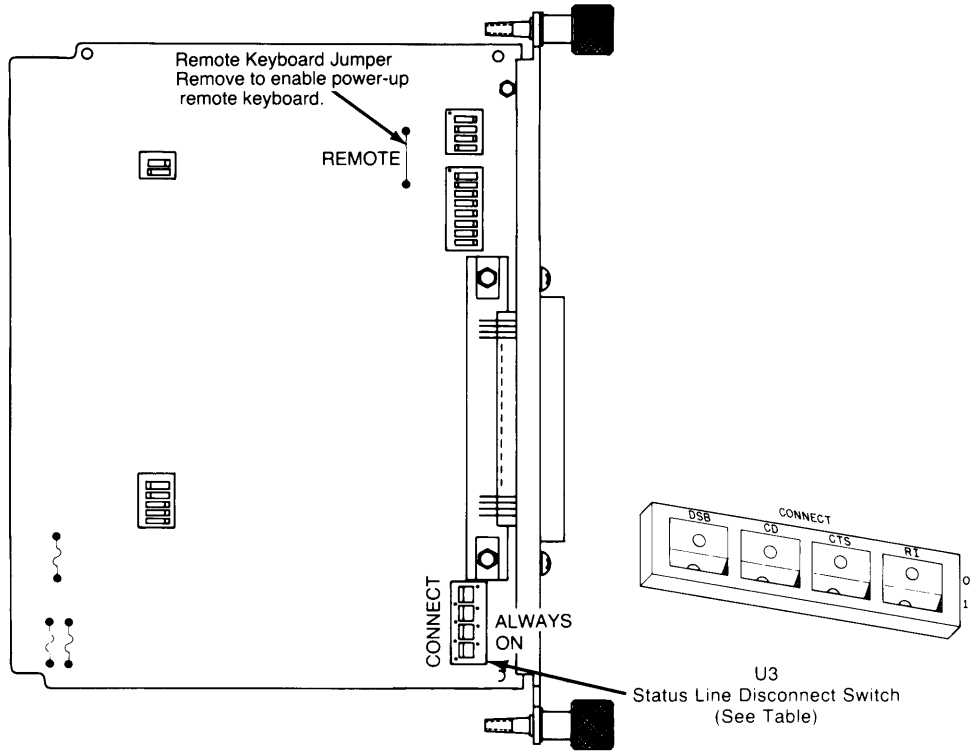

Condition	Switch Position
On Always	Not Connect
Connect to Line	Connect

Figure 2-4. Status Line Disconnect Switch Settings and Remote Keyboard Jumper



## Installing Interface Cards in the Backplane

Although there are eight slots in the computer backplane, only four interface cards can be installed in it. Each interface card installed decreases by one the number of memory boards which may be installed.

To install an interface card in the computer backplane, follow these instructions:

1. Set the switches on the card according to the instructions in the section on Configuring the Interface Card.
2. Turn the computer off.
3. Interface cards must go into any of the four slots just under a pair of cover bolt holes. Remove the metal backplane covers one by one until you find an empty slot just under a pair of cover bolt holes.
4. The metal plate on the interface card takes the place of a backplane cover. A memory or DMA board may be installed in the slot above the interface card.
5. Slide the interface card into the slot, component side up, until it bottoms against the backplane connectorboard. Then tighten the dog bolts until they are finger tight.
6. If there are no empty slots just under a cover bolt hole pair, you must rearrange the memory boards in order to accommodate the interface card. Remove any memory board in a slot under a bolt hole pair and re-install it in an empty slot above a bolt hole pair. It is not necessary to change the address of the memory board, as the computer CPU automatically finds the board at its new location.
7. If there are no empty slots, a memory board or interface card must be removed and left out if the interface card is to be installed. If a RAM memory board is left out, make sure that it is the RAM board with the lowest address.
8. Connect the computer to the desired peripheral using an appropriate cable.
9. Turn the computer and the peripheral on and operate according to the instructions in the appropriate operating manual. If problems are encountered, call the nearest HP Sales and Service Office.

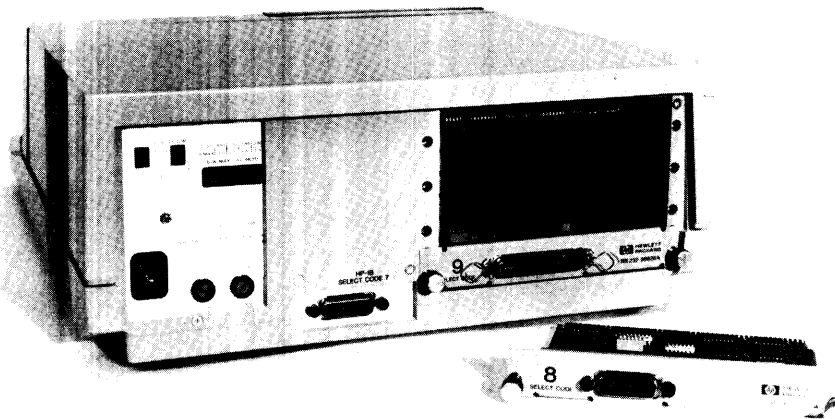

Figure 2-5. Installing the Interface Card in the Computer

Table 2-2. Cable Signals

**98626 Option 001 Cable (Male Connector Connects to Modem)**

Pin	Signal Name	Signal Direction
1	Protective Ground	N/A
2	Transmitted Data	98626 to Device
3	Received Data	Device to 98626
4	Request to Send	98626 to Device
5	Clear to Send	Device to 98626
6	Data Set Ready	Device to 98626
7	Signal Ground	N/A
8	Carrier Detect	Device to 98626
9 – 11	Unused	
12	Secondary Carrier Detect	Device to 98626
13 – 18	Unused	
19	Secondary Request to Send	98626 to Device
20	Data Terminal Ready	98626 to Device
21	Unused	
22	Ring Indicator	Device to 98626
23	Data Rate Select	98626 to Device
24 – 25	Unused	

**98626 Option 002 Cable (Female Connector Connects to Terminal)**

Pin	Signal Name	Signal Direction
1	Protective Ground	N/A
2	Transmitted Data	Device to 98626
3	Received Data	98626 to Device
4	Request to Send	Device to 98626
5	Clear to Send	98626 to Device
6	Data Set Ready	98626 to Device
7	Signal Ground	N/A
8	Carrier Detect	98626 to Device
9 – 11	Unused	
12	Secondary Carrier Detect	98626 to Device
13 – 18	Unused	
19	Secondary Request to Send	Device to 98626
20	Data Terminal Ready	Device to 98626
21	Unused	
22	Ring Indicator	98626 to Device
23 – 25	Unused	

## 2-8 Installation

**Table 2-3. Connector Wiring**

Pin	Wire Color	Function
1	Drain	Protective Ground
2	Black	Transmitted Data
3	Brown	Received Data
4	Red	Request to Send
5	Orange	Clear to Send
6	Yellow	Data Set Ready**
7	Green	Signal Ground
8	Blue	Carrier Detect
12	Violet	Secondary Carrier Detect
15	Grey	Unused*
17	White	Unused*
19	White/Black	Secondary Request to Send
20	White/Brown	Data Terminal Ready
22	White/Red	Ring Indicator**
23	White/Orange	Data Rate Select***
24	White/Yellow	Unused

\* Pins 15 and 17 are tied together in Option 2.

\*\* Pins 6 and 22 are tied together in Option 2.

\*\*\* Unused in Option 2.

# Appendix A

## RS-232C

### RS-232C Compatible

What is the meaning of “RS-232C” Compatible? Or, of more importance, what doesn’t it mean?

To answer the latter question first, it does not mean that every piece of equipment bearing that label will work perfectly with every other piece of equipment so labelled. What it does mean is that the equipment does not exceed any of the specifications or characteristics set down in the standard known as EIA RS-232C. But within the scope of RS-232C there is enough latitude to permit minor incompatibilities from one device to another, and these minor incompatibilities can cause unpleasant surprises for the unwary.

### What is RS-232C?

What is RS-232C? In 1963, the Electronic Industry Association (EIA) established a standard to govern the Interface Between Data Terminal Equipment and Data Communication Equipment Employing Serial Binary Interchange. The latest revision of this standard has been in effect since 1969 and is known colloquially as RS-232C. It specifies:

- Mechanical characteristics of the interface,
- Electrical characteristics of the interface,
- A number of interchange circuits with descriptions of their functions,
- The relationship of interchange circuits to standard interface types.

The Comité Consultatif International Téléphonique et Télégraphique (CCITT) has established standards that correspond to RS-232C. While these standards, CCITT V.24 and CCITT V.28, are very similar to RS-232C, they are not identical. Because it does not make use of all the circuits defined in both RS-232C and CCITT V.24, the 98626 Data Communications Interface conforms to both RS-232C and CCITT V.24 without any modification of the interface. The circuits which are utilized vary with different applications and with different modems. The drivers and receivers used in the 98626 conform to voltage and other electrical specifications of both CCITT V.28 and RS-232C.

## Mechanical Characteristics

The standard gives definitions to 22 pins and designates three pins as unassigned, but does not specify a 25-pin connector. Although a particular 25-pin connector is not defined, the industry has accepted the connector shown in Figure A-1 as a de facto standard. The male connector is used with data terminal equipment (the desktop computer), and the female connector is used with data communications equipment (the modem).

The length of the cable used by data terminal equipment to connect to data communications equipment should not be longer than 15.24 metres (50 feet). This is assuming that the load capacitance at the interface point is the worst case value of 2,500 picofarads. Longer cables are often used, especially in point-to-point configurations when the user knows that the total load capacitance will not exceed the 2,500 pf maximum.

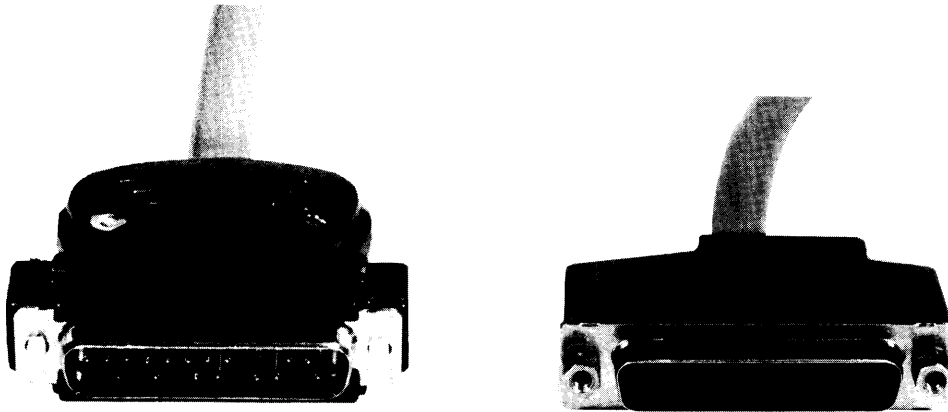
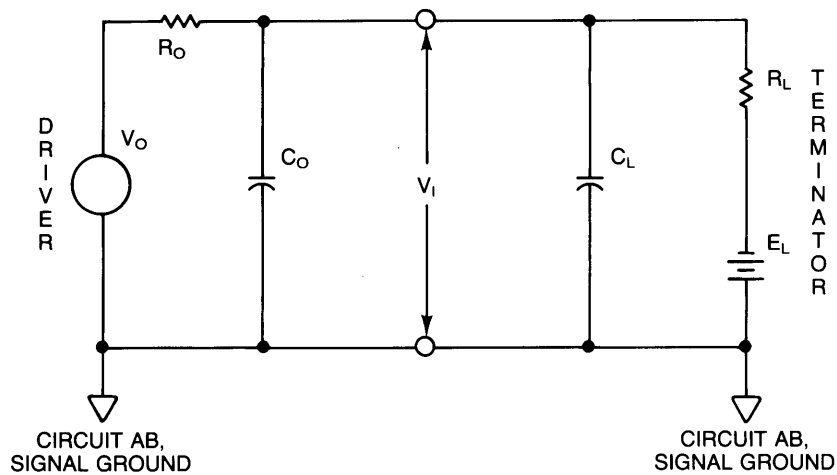

Figure A-1. 25-Pin Connector

## Electrical Characteristics

A number of electrical parameters and limitations are defined by RS-232C for each interchange circuit. They refer to the equivalent interchange circuit shown in Figure A-2. All voltage measurements are made at the interface point and with reference to signal ground.

- Open circuit voltage from the driver shall not be greater than +25 volts.
- The open circuit voltage of the terminator shall not exceed +2 volts.
- The total capacitance of the terminator shall not exceed 2,500 picofarads.
- The driver output voltage must be between 5 and 15 volts when the total terminator input resistance is between 3,000 $\Omega$  and 7,000 $\Omega$ .
- The output impedance of the driver circuit, when the driver power is off, shall not exceed 300 $\Omega$ .
- The rate of change of the driver output voltage (slew rate) shall not exceed 30 volts per microsecond.



**Figure A-2. Interchange Equivalent Circuit**

In addition, several rules define the logic state indicated by voltage levels on the circuit.

- A logical “1” (MARK) is indicated when the voltage at the interface point is more negative than  $-3$  volts.
- A logical “0” (SPACE) is indicated when the voltage at the interface point is more positive than  $+3$  volts.
- To indicate a “1” signal condition (MARK), the driver shall assert a voltage between  $-5$  volts and  $-15$  volts.
- To indicate a “0” signal condition (SPACE), the driver shall assert a voltage between  $+5$  volts and  $+15$  volts.

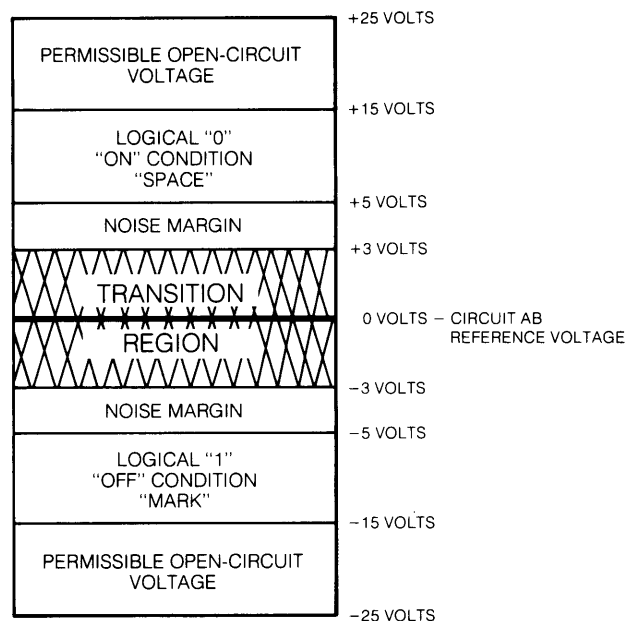

**Figure A-3. Circuit Voltage Levels**

## A-4 Appendix

Note that these standards allow for a 2-volt noise margin between the minimum driver voltage of 5 volts and the maximum undefined voltage of 3 volts. Other specifications that govern the transition region:

- All interchange signals entering the transition region shall proceed to the opposite valid signal state. It shall not re-enter the transition region until the next significant change in signal state.
- While in the transition region, the direction of the voltage change must not reverse.
- The time required for a control signal to cross the transition region shall not exceed one millisecond.
- The time required for a data or timing signal to cross the transition region shall not exceed one millisecond or four percent of the nominal signal period, whichever is the lesser.

# Appendix B

## RS-232C Function Table

This table contains the RS-232C functions, listed by pin number in the connector. Those functions marked with an asterisk are implemented in the 98626 interface.

Pin 1	*Protective Ground. Electrical equipment frame and ac power ground.
Pin 2	*Transmitted Data. Data originated by the terminal to be transmitted via the sending modem.
Pin 3	*Received Data. Data from the receiving modem in response to analog signals transmitted from the sending modem.
Pin 4	*Request to Send. Indicates to the sending modem that the terminal is ready to transmit data.
Pin 5	*Clear to Send. Indicates to the terminal that its modem is ready to transmit data.
Pin 6	*Data Set Ready. Indicates to the terminal that its modem is not in a test mode and that modem power is ON.
Pin 7	*Signal Ground. Establishes common reference between the modem and the terminal.
Pin 8	*Received Line Signal Detector. Indicates to the terminal that its modem is receiving carrier signals from the sending modem.
Pin 9	Reserved for test.
Pin 10	Reserved for test.
Pin 11	Unassigned.
Pin 12	*Secondary Received Line Signal Detector. Indicates to the terminal that its modem is receiving secondary carrier signals from the sending modem.
Pin 13	Secondary Clear to Send. Indicates to the terminal that its modem is ready to transmit signals via the secondary channel.
Pin 14	Secondary Transmitted Data. Data from the terminal to be transmitted by the sending modem's channel.
Pin 15	Transmitted Signal Element Timing. Signal from the modem to the transmitting terminal to provide signal element timing information.
Pin 16	Secondary Received Data. Data from the secondary channel of the modem in response to analog signals transmitted from the sending modem.
Pin 17	Receiver Signal Element Timing. Signal to the receiving terminal to provide signal element timing information.
Pin 18	Unassigned.



## B-2 Appendix

- Pin 19 \*Secondary Request to Send. Indicates to the modem that the sending terminal is ready to transmit data via the secondary channel.
- Pin 20 \*Data Terminal Ready. Indicates to the modem that the associated terminal is ready to receive and transmit data.
- Pin 21 Signal Quality Detector. Signal from the modem telling whether a defined error rate in the received data has been exceeded.
- Pin 22 \*Ring Indicator. Signal from the modem indicating that a ringing signal is being received over the line.
- Pin 23 \*Data Signal Rate Selector. Selects one of two signaling rates in modems having two rates.
- Pin 24 Transmit Signal Element Timing. Transmit clock provided by the terminal.
- Pin 25 Unassigned.

# Appendix C

## Replaceable Parts

### Introduction

This chapter contains part number information for the 98626 RS-232 interface.

The part number information is presented in this manner:

Table 1 lists the replaceable parts. Here is a description of each table column.

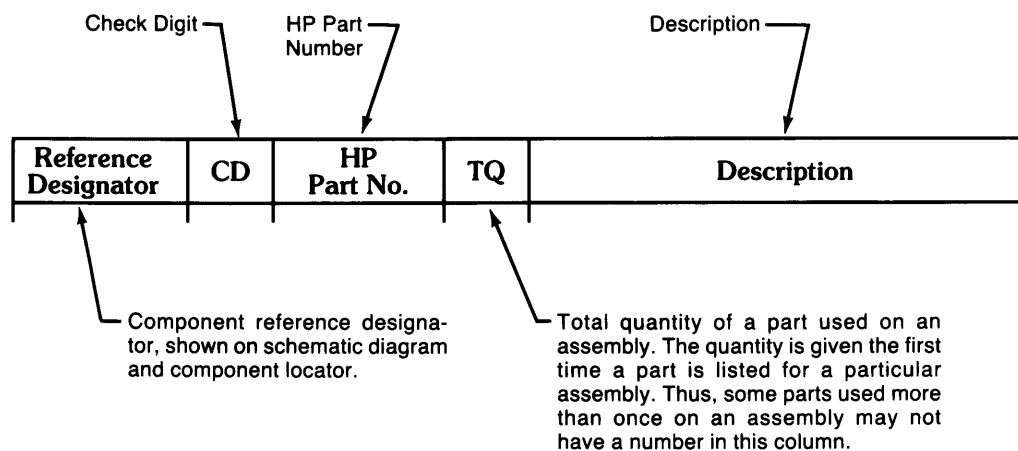

Parts may be ordered from Corporate Parts Center. The address is:

Corporate Parts Center  
333 Logue Avenue  
Mountain View, California 94042

The telephone number is: (415) 968-9200

Table C-1. Replaceable Parts

Reference Designation	HP Part Number	C D	Qty	Description	Mfr Code	Mfr Part Number
	98626-66501	3	1	ASSEMBLY-RS232	28480	98626-66501
C1	0160-4810	8	7	CAPACITOR-FXD 330PF +-5% 100VDC CER	28480	0160-4810
C2	0160-4810	8		CAPACITOR-FXD 330PF +-5% 100VDC CER	28480	0160-4810
C3	0160-4810	8		CAPACITOR-FXD 330PF +-5% 100VDC CER	28480	0160-4810
C4	0160-4810	8		CAPACITOR-FXD 330PF +-5% 100VDC CER	28480	0160-4810
C5	0160-4810	8		CAPACITOR-FXD 330PF +-5% 100VDC CER	28480	0160-4810
C6	0160-4810	8		CAPACITOR-FXD 330PF +-5% 100VDC CER	28480	0160-4810
C7	0160-4810	8		CAPACITOR-FXD 330PF +-5% 100VDC CER	28480	0160-4810
F8	0180-1746	5	2	CAPACITOR-FXD 150F+-10% 20VDC TA	56289	150D156X9020B2
C9	0180-1746	5	5	CAPACITOR-FXD 150F+-10% 20VDC TA	56289	150D156X9020B2
C10	0160-3847	9	6	CAPACITOR-FXD .01UF +100-0% 50VDC CER	28480	0160-3847
C11	0160-3847	9		CAPACITOR-FXD .01UF +100-0% 50VDC CER	28480	0160-3847
C12	0160-4830	2	1	CAPACITOR-FXD 2200PF +-10% 100VDC CER	28480	0160-4830
C13	0160-3847	9		CAPACITOR-FXD .01UF +100-0% 50VDC CER	28480	0160-3847
C14	0160-3847	9		CAPACITOR-FXD .01UF +100-0% 50VDC CER	28480	0160-3847
C15	0160-3847	9		CAPACITOR-FXD .01UF +100-0% 50VDC CER	28480	0160-3847
C16	0160-3847	9		CAPACITOR-FXD .01UF +100-0% 50VDC CER	28480	0160-3847
C17	0180-0228	6	1	CAPACITOR-FXD 220F+-10% 15VDC TA	56289	150D226X9015B2
CR1	1901-1098	1	2	DIODE-SWITCHING 1N4150 50V 200MA 4NS	9N171	1N4150
CR2	1901-1098	1	1	DIODE-SWITCHING 1N4150 50V 200MA 4NS	9N171	1N4150
F1	2110-0592	2	1	FUSE 4A 125V NTD .281X.093	28480	2110-0592
F2	2110-0423	8	1	FUSE 1.5A 125V NTD .281X.093	28480	2110-0423
F3	2110-0297	4	1	FUSE .5A 125V NTD .281X.093	28480	2110-0297
R1	0683-4725	2	4	RESISTOR 4.7K 5% .25W FC TC=-400/+700	01121	CR4725
R2	0683-4725	2		RESISTOR 4.7K 5% .25W FC TC=-400/+700	01121	CR4725
R3	0683-1525	4	1	RESISTOR 1.5K 5% .25W FC TC=-400/+700	01121	CR1525
R4	0683-4725	2		RESISTOR 4.7K 5% .25W FC TC=-400/+700	01121	CR4725
R5	0683-4725	2		RESISTOR 4.7K 5% .25W FC TC=-400/+700	01121	CR4725
R6	0683-1515	2	1	RESISTOR 150 5% .25W FC TC=-400/+600	01121	CR1515
U3	3101-2257	2	1	SWITCH-SL 4-SPDT DIP-SI IDE ASSY .1A	28480	3101-2257
U4	1810-0162	5	2	NETWORK-RES 14-DIP4.7K OHM X 13	11236	760-1-R4.7K
U5	1820-0509	5	2	IC DRV R DTL LINE DRV R QUAD	04713	MC1488L
U6	1820-0509	5	1	IC DRV R DTL LINE DRV R QUAD	04713	MC1488L
U7	1820-0990	8	2	IC RCVR DTL NAND LINE QUAD	01295	SN75189AJ
U8	1820-0990	8		IC RCVR DTL NAND LINE QUAD	01295	SN75189AJ
U9	1820-2024	3	4	IC DRV R TTL LS LINE DRV R OCTL	01295	SN74LS24AN
U10	1820-2024	3		IC DRV R TTL LS LINE DRV R OCTL	01295	SN74LS24AN
U11	1820-2443	0	1		28480	1820-2443
U12	1820-2024	3		IC DRV R TTL LS LINE DRV R OCTL	01295	SN74LS24AN
U13	1820-2024	3		IC DRV R TTL LS LINE DRV R OCTL	01295	SN74LS24AN
U14	1813-0202	0	1		28480	1813-0202
U15	1820-1112	8	2	IC FF TTL LS D-TYPE POS-EDGE-TRIG	01295	SN74LS74AN
U16	1820-1416	5	1	IC SCHMITT-TRIG TTL LS INV HEX 1-INP	01295	SN74LS14N
U17	1820-1245	8	1	IC DCDR TTL LS 2-TO-4-LINE DUAL 2-INP	01295	SN74LS155N
U18	1820-1197	9	1	IC GATE TTL LS NAND QUAD 2-INP	01295	SN74LS00N
U19	1820-1300	6	1	IC SHF-RGTR TTL LS R-S PRL-IN PRL-OUT	01295	SN74LS195AN
U21	1820-1202	7	1	IC GATE TTL LS NAND TPL 3-INP	01295	SN74LS10N
U22	1820-1144	6	1	IC GATE TTL LS NOR QUAD 2-INP	01295	SN74LS02N
U23	1810-0162	5		NETWORK-RES 14-DIP4.7K OHM X 13	11236	760-1-R4.7K
U25	1820-1112	8		IC FF TTL LS D-TYPE POS-EDGE-TRIG	01295	SN74LS74AN
U26	1820-1427	8	1	IC DCDR TTL LS 2-TO-4-LINE DUAL 2-INP	01295	SN74LS156N
U27	1820-1568	8	1	IC BFR TTL LS BUS QUAD	01295	SN74LS25AN
U28	1820-1195	7	1	IC FF TTL LS D-TYPE POS-EDGE-TRIG COM	01295	SN74LS175N
U29	1820-2740	0	1	IC COMPTR TTL LS MAGTD 2-INP 8-BIT	01295	SN74LS688N
U30	1820-2075	4	1	IC MISC TTL LS	01295	SN74LS245N
	1251-7161	2	1	CONNECTOR-50PST RING	28480	1251-7161
	3101-2506	4	1	SWITCH ASSEMBLY-ROCKER	28480	3101-2506
	3101-2507	5	1	SWITCH ASSEMBLY-ROCKER	28480	3101-2507
	3101-2508	6	1	SWITCH ASSEMBLY-ROCKER	28480	3101-2508
	3101-2510	0	1	SWITCH ASSEMBLY-ROCKER	28480	3101-2510

See introduction to this section for ordering information  
 \*Indicates factory selected value

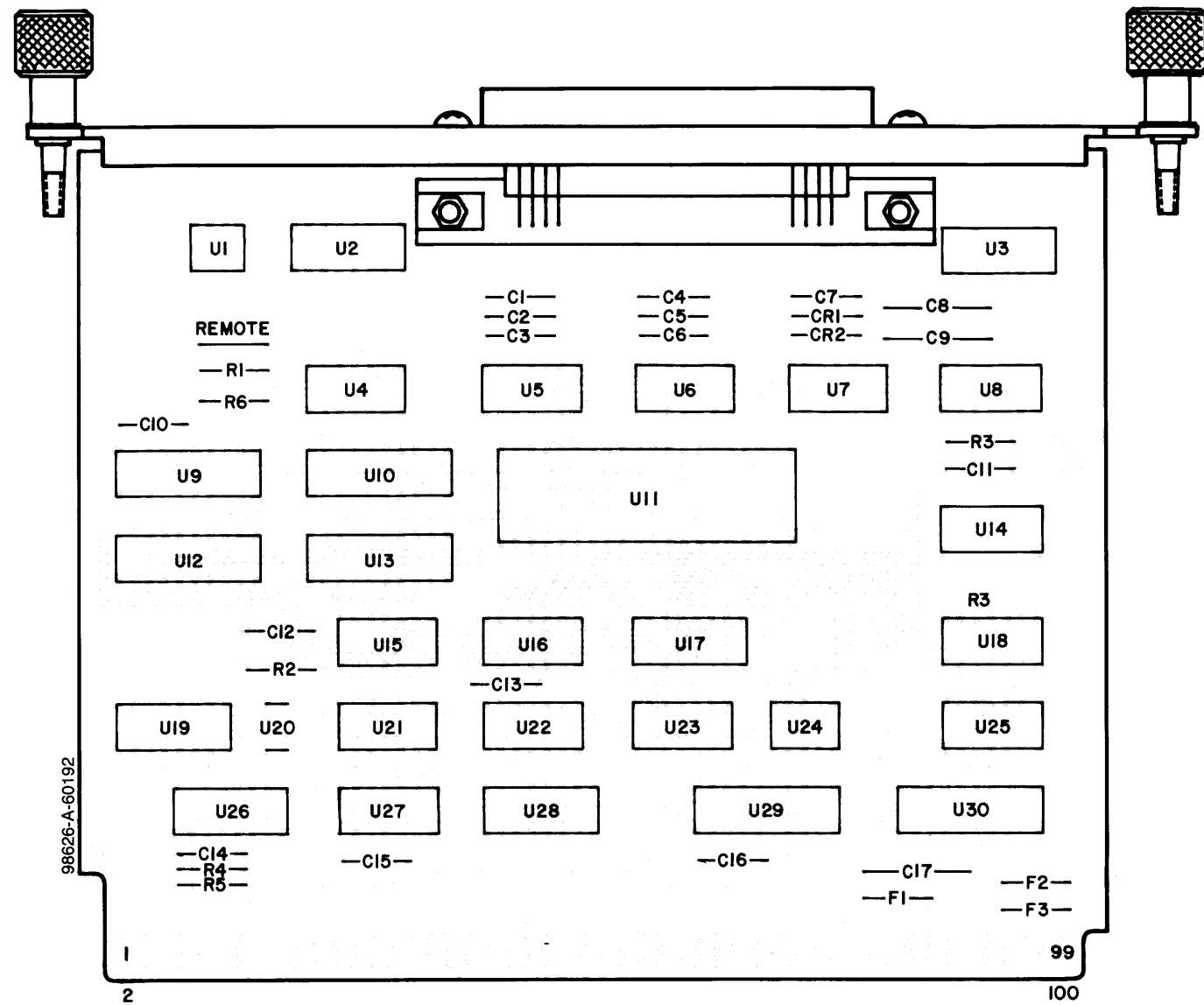

## COMPONENT SIDE A1

HP Part No. 98626-66501 Rev C

### SCHEMATIC NOTES

- PARTIAL REFERENCE DESIGNATIONS ARE SHOWN, PREFIX WITH ASSEMBLY OR SUBASSEMBLY DESIGNATION(S) OR BOTH FOR COMPLETE DESIGNATION.
- COMPONENT VALUES ARE SHOWN AS FOLLOWS UNLESS OTHERWISE NOTED.  
RESISTANCE IN OHMS  
CAPACITANCE IN MICROFARADS
- A CURVED LINE MEETING A BUS DENOTES THAT LINE ENTERS THE BUS, A STRAIGHT LINE MEETING THE BUS DENOTES THAT LINE DOES NOT ENTER THE BUS.

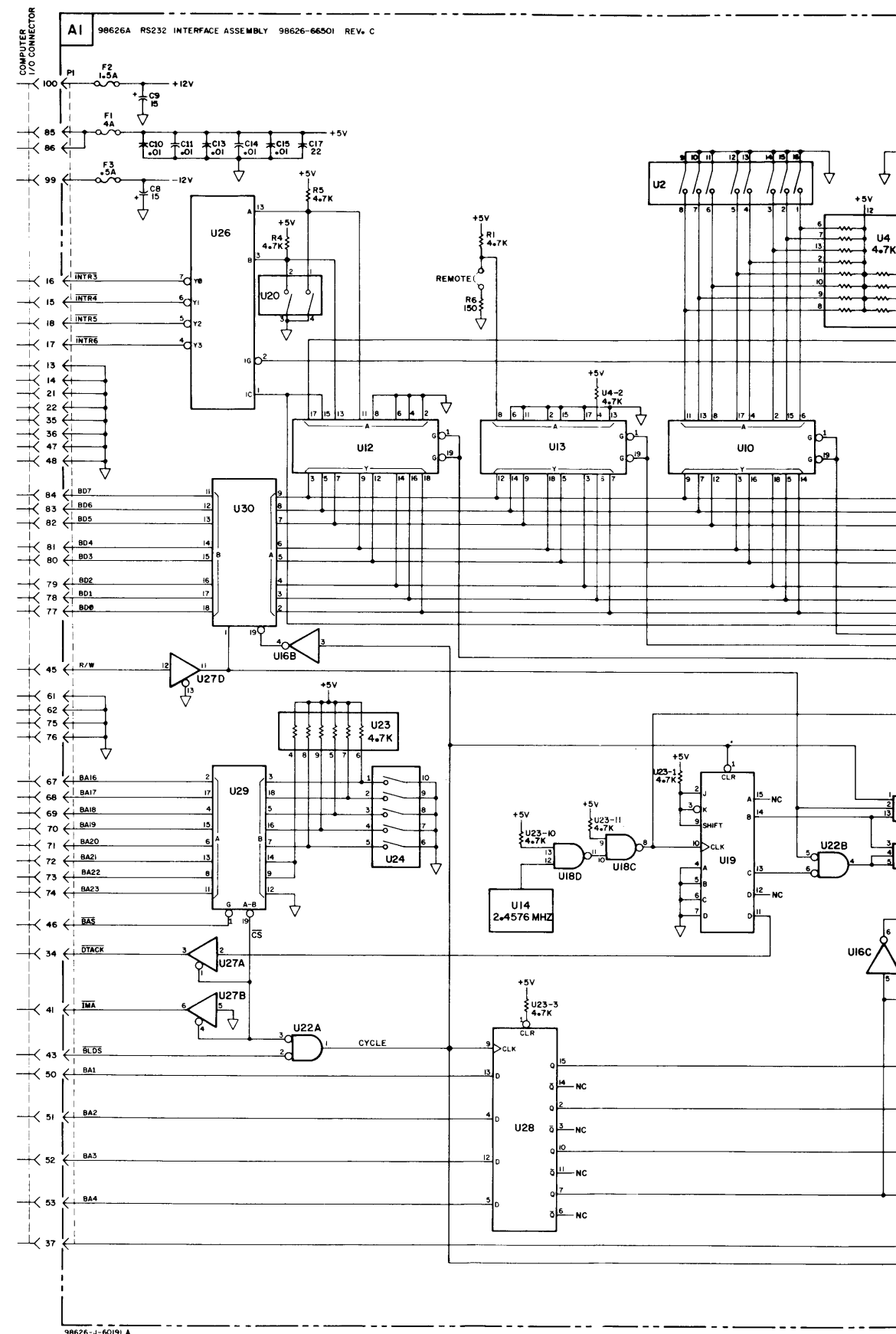

98626-J-60191 A

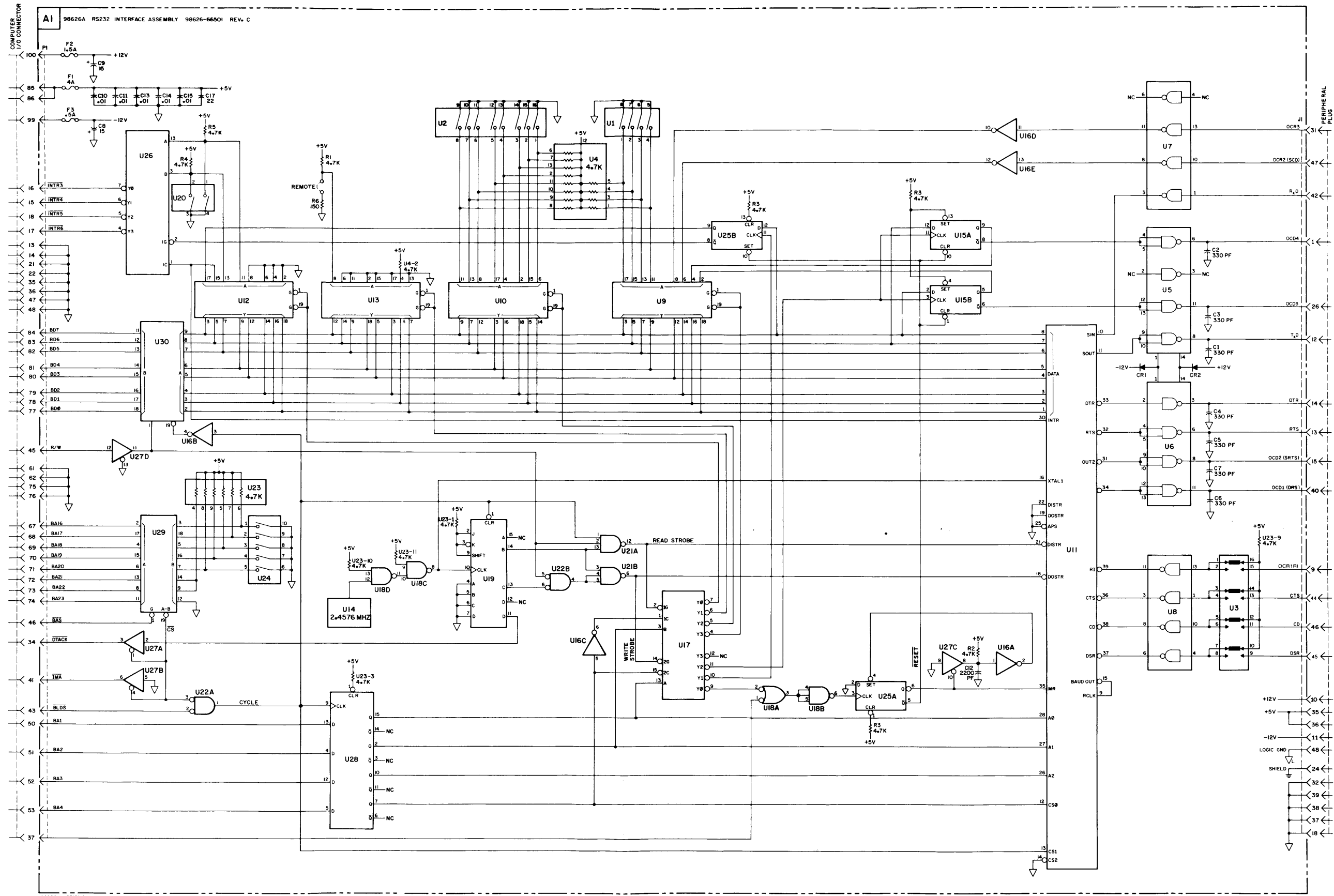
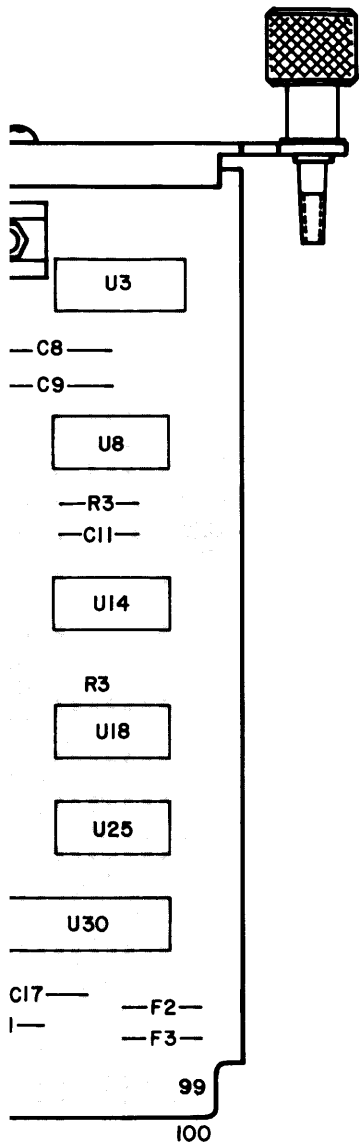

ASSEMBLY OR  
ED.

A STRAIGHT LINE

COPYRIGHT BY HEWLETT-PACKARD COMPANY 1982

**HEWLETT  
PACKARD**

Roseville Networks Division  
8000 Foothills Boulevard  
Roseville, California 95678

A1

RS232 INTERFACE ASSEMBLY BOARD  
SCHEMATIC DIAGRAM

Manual Part No. 98626-90000      Dwg Rev. A      Sheet 1 of 1

