User's Guide

Real-Time C Debugger for Motorola 6830x-Family Emulator/Analyzer

Notice

Hewlett-Packard makes no warranty of any kind with regard to this material, including, but not limited to, the implied warranties of merchantability and fitness for a particular purpose. Hewlett-Packard shall not be liable for errors contained herein or for incidental or consequential damages in connection with the furnishing, performance, or use of this material.

Hewlett-Packard assumes no responsibility for the use or reliability of its software on equipment that is not furnished by Hewlett-Packard.

© Copyright 1996, Hewlett-Packard Company.

This document contains proprietary information, which is protected by copyright. All rights are reserved. No part of this document may be photocopied, reproduced or translated to another language without the prior written consent of Hewlett-Packard Company. The information contained in this document is subject to change without notice.

MS-DOS(R) is a U.S. registered trademark of Microsoft Corporation.

HP-UX 9.* and 10.0 for HP 9000 Series 700 and 800 computers are X/Open Company UNIX 93 branded products.

TrueType(TM) is a U.S. trademark of Apple Computer, Inc.

UNIX(R) is a registered trademark in the United States and other countries, licensed exclusively through X/Open Company Limited.

Windows or MS Windows is a U.S. trademark of Microsoft Corporation.

Hewlett-Packard
P.O. Box 2197
1900 Garden of the Gods Road
Colorado Springs, CO 80901-2197, U.S.A.

RESTRICTED RIGHTS LEGEND Use, duplication, or disclosure by the U.S. Government is subject to restrictions as set forth in subparagraph (c) (1)(ii) of the Rights in Technical Data and Computer Software Clause at DFARS 252.227-7013. Hewlett-Packard Company, 3000 Hanover Street, Palo Alto, CA 94304 U.S.A. Rights for non-DOD U.S. Government Departments and Agencies are as set forth in FAR 52.227-19(c)(1,2).

Printing History

New editions are complete revisions of the manual. The date on the title page changes only when a new edition is published.

A software code may be printed before the date; this indicates the version level of the software product at the time the manual was issued. Many product updates and fixes do not require manual changes, and manual corrections may be done without accompanying product changes. Therefore, do not expect a one-to-one correspondence between product updates and manual revisions.

Edition 1 B3638-97000, July 1996

Edition 2 B3638-97001, November 1996

Safety, Certification and Warranty

Safety and certification and warranty information can be found at the end of this manual on the pages before the back cover.

Real-Time C Debugger — Overview

The Real-Time C Debugger is an MS Windows application that lets you debug C language programs for embedded microprocessor systems.

The debugger controls HP 64700 emulators and analyzers either on the local area network (LAN) or connected to a personal computer with an RS-232C interface or the HP 64037 RS-422 interface. It takes full advantage of the emulator's real-time capabilities to allow effective debug of C programs while running in real-time.

The debugger is an MS Windows application

- You can display different types of debugger information in different windows, just as you display other windows in MS Windows applications.
- You can complete a wide variety of debug-related tasks without exiting the debugger. You can, for example, edit files or compile your programs without exiting the debugger.
- You can cut text from the debugger windows to the clipboard, and clipboard contents may be pasted into other windows or dialog boxes.

The debugger communicates at high speeds

- You can use the HP 64700 LAN connection or the RS-422 connection for high-speed data transfer (including program download). These connections give you an efficient debugging environment.

You can debug programs in C context

- You can display C language source files (optionally with intermixed assembly language code).
- You can display program symbols.
- You can display the stack backtrace.
- You can display and edit the contents of program variables.
- You can step through programs, either by source lines or assembly language instructions.
- You can step over functions.
- You can run programs until the current function returns.
- You can run programs up to a particular source line or assembly language instruction.

- You can set breakpoints in the program and define macros (which are collections of debugger commands) that execute when the breakpoint is hit. Break macros provide for effective debugging without repeated command entry.

You can display and modify processor resources

- You can display and edit the contents of memory locations in hexadecimal or as C variables.
- You can display and edit the contents of microprocessor registers including on-chip peripheral registers.
- You can display and modify individual bits and fields of bit-oriented registers.

You can trace program execution

- You can trace control flow at the C function level.
- You can trace the callers of a function.
- You can trace control flow within a function at the C statement level.
- You can trace all C statements that access a variable.
- You can trace before, and break program execution on, a C variable being set to a specified value.
- You can make custom trace specifications.

You can debug your program while it runs continuously at full speed

- You can configure the debugger to prevent it from automatically initiating any action that may interrupt user program execution. This ensures that the user program executes in real time, so you can debug your design while it runs in a real-world operating mode.
- You can inspect and modify C variables and data structures without interrupting execution.
- You can set and clear breakpoints without interrupting execution.
- You can perform all logic analysis functions, observing C program and variable activity, without interrupting program execution.

In This Book

This book documents the Real-Time C Debugger for 6830x. It is organized into five parts whose chapters are described below.

Part 1. Quick Start Guide

Chapter 1 quickly shows you how to use the debugger.

Part 2. User's Guide

Chapter 2 shows you how to use the debugger interface.

Chapter 3 shows you how to configure the emulator.

Chapter 4 shows you how to plug the emulator into target systems.

Chapter 5 shows how to perform the tasks that you can use to debug programs.

Part 3. Reference

Chapter 6 contains a summary of the debugger commands as they are used in command files and break macros.

Chapter 7 describes the format for expressions used in commands.

Chapter 8 describes commands that appear in the menu bar.

Chapter 9 describes commands that appear in debugger window control menus.

Chapter 10 describes commands that appear in pop-up menus.

Chapter 11 describes commands that are only available in command files and break macros.

Chapter 12 describes error messages and provides recovery information.

Part 4. Concept Guide

Chapter 13 contains conceptual (and more detailed) information on various topics.

Part 5. Installation Guide

Chapter 14 shows you how to install the debugger.

Chapter 15 shows you how to install or update HP 64700 firmware.

Contents

Part 1 Quick Start Guide

1 Getting Started

- Step 1. Start the debugger 25
- Step 2. Adjust the fonts and window size 26
- Step 3. Set the reset value for the supervisor stack pointer and program counter 27
- Step 4. Map memory for the demo program 29
- Step 5. Load the demo program 31
- Step 6. Display the source file 32
- Step 7. Set a breakpoint 33
- Step 8. Run the demo program 34
- Step 9. Delete the breakpoint 35
- Step 10. Single-step one line 36
- Step 11. Single-step 10 lines 37
- Step 12. Display a variable 38
- Step 13. Edit a variable 39
- Step 14. Monitor a variable in the WatchPoint window 40
- Step 15. Run until return from current function 41
- Step 16. Step over a function 42
- Step 17. Run the program to a specified line 43
- Step 18. Display register contents 44
- Step 19. Trace function flow 46
- Step 20. Trace a function's callers 47
- Step 21. Trace access to a variable 49
- Step 22. Exit the debugger 50

Part 2 User's Guide

2 Using the Debugger Interface

How the Debugger Uses the Clipboard 55

Debugger Function Key Definitions 56

Starting and Exiting the Debugger 57

To start the debugger 57

To exit the debugger 58

To create an icon for a different emulator 58

Working with Debugger Windows 60

To open debugger windows 60

To copy window contents to the list file 61

To change the list file destination 61

To change the debugger window fonts 62

To set tab stops in the Source window 62

To set colors in the Source window 63

Using Command Files 64

To create a command file 64

To execute a command file 65

To create buttons that execute command files 66

3 Configuring the Emulator

Setting the Hardware Options 69

To select the emulator clock source 70

To select the processor data bus width 71

To specify the target memory access size 71

To specify the TRAP number for software breakpoints 72

To enable or disable breaks on writes to ROM 73

To enable or disable the target /BERR signal 74

To enable or disable freeze of peripherals during monitor execution 75

To enable or disable buffering of the chip-select lines to the target system 76

To enable or disable buffering of the function-code lines to the target system	77
To enable or disable buffering of the read/write line to the target system	78
To enable or disable buffering of the strobe lines to the target system	79
To enable or disable buffering of the write-enable lines to the target system	80
To enable or disable drive of background monitor cycles to the target system	81
To enable or disable driving /DTACK high (deassert) after each assertion	82
To enable or disable target system interrupts	83
To enable or disable tracing of DMA cycles	83
To specify initial values for the SSP and PC	84
To specify control of the /DTACK signal	85
To specify the use of the /IACK7/PB0 pin	86
To specify operation during an Interrupt 7 occurrence	87
Mapping Memory	88
To map memory	88
Using the EMSIM Registers	91
EMSIM registers in the emulator	91
To view the SIM register differences	93
To synchronize to the 6830x SIM registers	93
To synchronize to the EMSIM registers	94
To reset the EMSIM registers to processor defaults	94
Verifying the Emulator Configuration	95
To check for configuration inconsistencies	95
To check emulator clock setup	96
To display information about chip selects	96
To display information about bus interface ports	97
To display information about the memory map	97
To display information about the reset mode configuration	98
To display assembly code for setting up the SIM	98
Setting Up the BNC Port	99
To output the trigger signal on the BNC port	99
To receive an arm condition input on the BNC port	99

Saving and Loading Configurations	100
To save the current emulator configuration	100
To load an emulator configuration	101
Setting the Real-Time Options	102
To allow or deny monitor intrusion	103
To turn polling ON or OFF	104
4 Plugging the Emulator into Target Systems	
Connecting the Emulator Probe	107
To plug in the emulator probe	107
Configuring the Emulator for In-Circuit Operation	108
Step 1. Understand the important concepts	108
Step 2. Set up your chip selects	110
Step 3. Reprogram chip-select base addresses	112
Step 4. Know your interrupt mode	115
Step 5. Set up the DTACK signals	117
Step 6. If emulator status shows HALTED	118
Step 7. Choose the correct target memory access size	120
Step 8. Check your DTACK pullup resistor!	121
If you have problems	123
5 Debugging Programs	
Loading and Displaying Programs	129
To load user programs	129
To display source code only	130
To display source code mixed with assembly instructions	130
To display source files by their names	131
To specify source file directories	132
To search for function names in the source files	133
To search for addresses in the source files	133
To search for strings in the source files	134

Displaying Symbol Information	135
To display program module information	136
To display function information	136
To display external symbol information	137
To display local symbol information	138
To display global assembler symbol information	139
To display local assembler symbol information	139
To create a user-defined symbol	140
To display user-defined symbol information	141
To delete a user-defined symbol	142
To display the symbols containing the specified string	142
Stepping, Running, and Stopping the Program	143
To step a single line or instruction	143
To step over a function	144
To step multiple lines or instructions	145
To run the program until the specified line	146
To run the program until the current function return	146
To run the program from a specified address	147
To stop program execution	147
To reset the processor	148
Using Breakpoints and Break Macros	149
To set a breakpoint	150
To disable a breakpoint	151
To delete a single breakpoint	151
To list the breakpoints and break macros	152
To set a break macro	152
To delete a single break macro	155
To delete all breakpoints and break macros	156
Displaying and Editing Variables	157
To display a variable	157
To edit a variable	158
To monitor a variable in the WatchPoint window	159

Contents

Displaying and Editing Memory	160
To display memory	160
To edit memory	162
To copy memory to a different location	163
To copy target system memory into emulation memory	164
To modify a range of memory with a value	165
To search memory for a value or string	166
Displaying and Editing I/O Locations	167
To display I/O locations	167
To edit an I/O location	168
Displaying and Editing Registers	169
To display registers	169
To edit registers	171
Tracing Program Execution	172
To trace function flow	174
To trace callers of a specified function	175
To trace execution within a specified function	177
To trace accesses to a specified variable	178
To trace before a particular variable value and break	179
To trace until the command is halted	181
To stop a running trace	181
To repeat the last trace	181
To identify bus arbitration cycles in the trace	182
To display bus cycles	182
To display absolute or relative counts	183
Setting Up Custom Trace Specifications	184
To set up a "Trigger Store" trace specification	185
To set up a "Find Then Trigger" trace specification	188
To set up a "Sequence" trace specification	193
To edit a trace specification	197
To trace "windows" of program execution	197
To store the current trace specification	199
To load a stored trace specification	200

Part 3 Reference

6 Command File and Macro Command Summary

WAIT Command Dialog Box 208

7 Expressions in Commands

Numeric Constants 211

Symbols 212

Function Codes 215

C Operators 215

8 Menu Bar Commands

File→Load Object... (ALT, F, L) 221

File→Command Log→Log File Name... (ALT, F, C, N) 224

File→Command Log→Logging ON (ALT, F, C, O) 225

File→Command Log→Logging OFF (ALT, F, C, F) 226

File→Run Cmd File... (ALT, F, R) 227

File→Load Debug... (ALT, F, D) 229

File→Save Debug... (ALT, F, S) 230

File→Load Emulator Config... (ALT, F, E) 231

File→Save Emulator Config... (ALT, F, V) 232

File→Copy Destination... (ALT, F, P) 233

File→Exit (ALT, F, X) 234

File→Exit HW Locked (ALT, F, H) 235

File Selection Dialog Boxes 236

Execution→Run (F5), (ALT, E, U) 237

Execution→Run to Cursor (ALT, E, C) 238

Execution→Run to Caller (ALT, E, T) 239

Execution→Run... (ALT, E, R) 240

Execution→Single Step (F2), (ALT, E, N) 242

Execution→Step Over (F3), (ALT, E, O) 243

Execution→Step... (ALT, E, S) 244

Execution→Break (F4), (ALT, E, B) 248

Execution→Reset (ALT, E, E) 249

Breakpoint→Set at Cursor (ALT, B, S) 250

Breakpoint→Delete at Cursor (ALT, B, D) 251

Breakpoint→Set Macro... (ALT, B, M) 252

Contents

Breakpoint→Delete Macro (ALT, B, L)	255
Breakpoint→Edit... (ALT, B, E)	256
Variable→Edit... (ALT, V, E)	258
Variable Modify Dialog Box	260
Trace→Function Flow (ALT, T, F)	261
Trace→Function Caller... (ALT, T, C)	262
Trace→Function Statement... (ALT, T, S)	264
Trace→Variable Access... (ALT, T, V)	266
Trace→Variable Break... (ALT, T, B)	268
Trace→Edit... (ALT, T, E)	270
Trace→Trigger Store... (ALT, T, T)	271
Trace→Find Then Trigger... (ALT, T, D)	274
Trace→Sequence... (ALT, T, Q)	278
Trace→Until Halt (ALT, T, U)	282
Trace→Halt (ALT, T, H)	283
Trace→Again (F7), (ALT, T, A)	284
Condition Dialog Boxes	285
Trace Pattern Dialog Box	288
Trace Range Dialog Box	290
Sequence Number Dialog Box	292
RealTime→Monitor Intrusion→Disallowed (ALT, R, T, D)	293
RealTime→Monitor Intrusion→Allowed (ALT, R, T, A)	294
RealTime→I/O Polling→ON (ALT, R, I, O)	295
RealTime→I/O Polling→OFF (ALT, R, I, F)	296
RealTime→Watchpoint Polling→ON (ALT, R, W, O)	297
RealTime→Watchpoint Polling→OFF (ALT, R, W, F)	298
RealTime→Memory Polling→ON (ALT, R, M, O)	299
RealTime→Memory Polling→OFF (ALT, R, M, F)	300
Assemble... (ALT, A)	301
Settings→Emulator Config→Hardware... (ALT, S, E, H)	302
Settings→Emulator Config→Memory Map... (ALT, S, E, M)	311
Settings→Emulator Config→Information... (ALT, S, E, I)	314
Settings→Communication... (ALT, S, C)	318
Settings→BNC→Outputs Analyzer Trigger (ALT, S, B, O)	321
Settings→BNC→Input to Analyzer Arm (ALT, S, B, I)	323
Settings→Font... (ALT, S, F)	324
Settings→Tabstops... (ALT, S, T)	326
Settings→Symbols→Case Sensitive→ON (ALT, S, S, C, O)	327
Settings→Symbols→Case Sensitive→OFF (ALT, S, S, C, F)	327

Settings→Extended→Trace Cycles→User (ALT, S, X, T, U)	328
Settings→Extended→Trace Cycles→Monitor (ALT, S, X, T, M)	328
Settings→Extended→Trace Cycles→Both (ALT, S, X, T, B)	329
Settings→Extended→Load Error Abort→ON (ALT, S, X, L, O)	330
Settings→Extended→Load Error Abort→OFF (ALT, S, X, L, F)	330
Settings→Extended→Source Path Query→ON (ALT, S, X, S, O)	331
Settings→Extended→Source Path Query→OFF (ALT, S, X, S, F)	331
Window→Cascade (ALT, W, C)	332
Window→Tile (ALT, W, T)	332
Window→Arrange Icons (ALT, W, A)	332
Window→1-9 (ALT, W, 1-9)	333
Window→More Windows... (ALT, W, M)	334
Help→About Debugger/Emulator... (ALT, H, D)	335
Source Directory Dialog Box	336
WAIT Command Dialog Box	337

9 Window Control Menu Commands

Common Control Menu Commands	341
Copy→Window (ALT, -, P, W)	341
Copy→Destination... (ALT, -, P, D)	342
Button Window Commands	343
Edit... (ALT, -, E)	343
Device Regs Window Commands	346
Continuous Update (ALT, -, U)	346
Expression Window Commands	347
Clear (ALT, -, R)	347
Evaluate... (ALT, -, E)	348
I/O Window Commands	349
Define... (ALT, -, D)	349
Memory Window Commands	351
Display→Linear (ALT, -, D, L)	351
Display→Block (ALT, -, D, B)	352

Contents

Display→Byte (ALT, -, D, Y)	352
Display→16 Bit (ALT, -, D, 1)	352
Display→32 Bit (ALT, -, D, 3)	352
Search... (ALT, -, R)	353
Utilities→Copy... (ALT, -, U, C)	355
Utilities→Fill... (ALT, -, U, F)	356
Utilities→Image... (ALT, -, U, I)	357
Utilities→Load... (ALT, -, U, L)	359
Utilities→Store... (ALT, -, U, S)	360
Register Window Commands	362
Copy→Registers (ALT, -, P, R)	362
Register Bit Fields Dialog Box	363
Source Window Commands	365
Display→Mixed Mode (ALT, -, D, M)	365
Display→Source Only (ALT, -, D, S)	366
Display→Select Source... (ALT, -, D, L)	366
Search→String... (ALT, -, R, S)	367
Search→Function... (ALT, -, R, F)	369
Search→Address... (ALT, -, R, A)	370
Search→Current PC (ALT, -, R, C)	371
Search Directories Dialog Box	372
Symbol Window Commands	373
Display→Modules (ALT, -, D, M)	373
Display→Functions (ALT, -, D, F)	374
Display→Externals (ALT, -, D, E)	374
Display→Locals... (ALT, -, D, L)	375
Display→Asm Globals (ALT, -, D, G)	376
Display→Asm Locals... (ALT, -, D, A)	376
Display→User defined (ALT, -, D, U)	378
Copy→Window (ALT, -, P, W)	378
Copy→All (ALT, -, P, A)	379
FindString→String... (ALT, -, F, S)	379
User defined→Add... (ALT, -, U, A)	380
User defined→Delete (ALT, -, U, D)	381
User defined→Delete All (ALT, -, U, L)	382

Trace Window Commands	383
Display→Mixed Mode (ALT, -, D, M)	383
Display→Source Only (ALT, -, D, S)	384
Display→Bus Cycle Only (ALT, -, D, C)	384
Display→Count→Absolute (ALT, -, D, C, A)	385
Display→Count→Relative (ALT, -, D, C, R)	385
Copy→Window (ALT, -, P, W)	386
Copy→All (ALT, -, P, A)	386
Search→Trigger (ALT, -, R, T)	387
Search→State... (ALT, -, R, S)	387
Trace Spec Copy→Specification (ALT, -, T, S)	388
Trace Spec Copy→Destination... (ALT, -, T, D)	388
WatchPoint Window Commands	389
Edit... (ALT, -, E)	389

10 Window Pop-Up Commands

BackTrace Window Pop-Up Commands	395
Source at Stack Level	395
Source Window Pop-Up Commands	396
Set Breakpoint	396
Clear Breakpoint	396
Evaluate It	396
Add to Watch	397
Run to Cursor	397

11 Other Command File and Macro Commands

BEEP	401
EXIT	402
FILE CHAINCMD	403
FILE RERUN	404
NOP	405
TERMCMD	406
WAIT	408

12 Error Messages

Error Messages	410
Bad RS-232 port name	411
Bad RS-422 card I/O address	411
Could not open initialization file	411
Could not write Memory	412
EMIPLCR value is not consistent with VCCSYN/MODCLK	413
Error occurred while processing Object file	415
General RS-232 communications error	416
General RS-422 communications error	416
HP 64700 locked by another user	417
HP 64700 not responding	417
Incorrect DLL version	417
Incorrect LAN Address (HP-ARPA, Windows for Workgroups)	418
Incorrect LAN Address (Novell)	419
Incorrect LAN Address (WINSOCK)	419
Internal error in communications driver	420
Internal error in Windows	420
Interrupt execution (during run to caller)	420
Interrupt execution (during step)	421
Interrupt execution (during step over)	421
Invalid transport name	422
LAN buffer pool exhausted	422
LAN communications error	423
LAN MAXSENDSIZE is too small	423
LAN socket error	423
Object file format ERROR	424
Out of DOS Memory for LAN buffer	425
Out of Windows timer resources	426
PC is out of RAM memory	426
Timed out during communications	427

Part 4 Concept Guide**13 Concepts**

Debugger Windows	433
The BackTrace Window	434
The Button Window	435
Device Regs Window	436
Device Register Dialogs	437
The Expression Window	438
The I/O Window	439
The Memory Window	440
The Register Window	441
The Source Window	443
The Status Window	446
The Symbol Window	449
The Trace Window	450
The WatchPoint Window	452
Compiler/Assembler Specifications	453
IEEE-695 Object Files	453
Compiling Programs with MCC68K	455
Compiling Programs with AxLS	456
Trace Signals and Predefined Status Values	458

Part 5 Installation Guide

14 Installing the Debugger

- Requirements 463
- Before Installing the Debugger 464
- Step 1. Connect the HP 64700 to the PC 465
 - To connect via RS-232 465
 - To connect via LAN 468
 - To connect via RS-422 472
 - If you cannot verify RS-232 communication 473
 - If you cannot verify LAN communication 474
- Step 2. Install the debugger software 475
- Step 3. Start the debugger 478
 - If you have RS-232 connection problems 478
 - If you have LAN connection problems 481
 - If you have LAN DLL errors 482
 - If you have RS-422 connection problems 483
- Step 4. Check the HP 64700 system firmware version 484
- Optimizing PC Performance for the Debugger 485

15 Installing/Updating HP 64700 Firmware

- Step 1. Connect the HP 64700 to the PC 489
- Step 2. Install the firmware update utility 491
- Step 3. Run PROGFLASH to update HP 64700 firmware 494
- Step 4. Verify emulator performance 496

Glossary

Index

Part 1

Quick Start Guide

A few task instructions to help you get comfortable.

Part 1

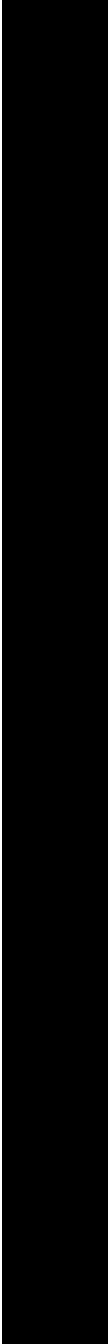



Getting Started

Getting Started

This tutorial helps you get comfortable by showing you how to perform some measurements on a demo program. This tutorial shows you how to:

- 1 Start the debugger.
- 2 Adjust the fonts and window size.
- 3 Set the reset value for the supervisor stack pointer and program counter.
- 4 Map memory for the demo program.
- 5 Load the demo program.
- 6 Display the source file.
- 7 Set a breakpoint.
- 8 Run the demo program.
- 9 Delete the breakpoint.
- 10 Single-step one line.
- 11 Single-step 10 lines.
- 12 Display a variable.
- 13 Edit a variable.
- 14 Monitor a variable in the WatchPoint window.
- 15 Run until return from current function.
- 16 Step over a function.
- 17 Run the program to a specified line.
- 18 Display register contents.
- 19 Trace function flow.
- 20 Trace a function's callers.
- 21 Trace access to a variable.
- 22 Exit the debugger.

Demo Programs

Demo programs are included with the Real-Time C Debugger in the C:\HP\RTC\M30X\DEMO directory (if C:\HP\RTC\M30X was the installation path chosen when installing the debugger software).

Subdirectories exist for the SAMPLE demo program, which is a simple C program that does case conversion on a couple strings, and for the ECS demo program, which is a somewhat more complex C program for an environmental control system.

Each of these demo program directories contains a README file that describes the program and batch files that show you how the object files were made.

This tutorial shows you how to perform some measurements on the SAMPLE demo program.



Step 1. Start the debugger

- Open the HP Real-Time C Debugger group box and double-click the 6830X debugger icon.

Or:

- 1** Choose the File→Run (ALT, F, R) command in the Windows Program Manager.
- 2** Enter the debugger startup command, C:\HP\RTC\M30X\B3638.EXE (if C:\HP\RTC\M30X was the installation path chosen when installing the debugger software).
- 3** Choose the OK button.

If an emulator status message appears on screen, choose the OK button. You will satisfy the emulator status problem in a later step.

Step 2. Adjust the fonts and window size

The first time RTC is used, a default window and font size is used. This may not be the best for your display. You may change the font type and size with the Settings→Font... command, and change the window size by using standard Windows 3.1 methods (moving the mouse to the edge of the window and dragging the mouse to resize the window).

- 1** Choose the Settings→Font... (ALT, S, F) command.
- 2** Choose the Font, Font Style, and Size desired in the Font dialog box.
- 3** Choose the OK button to apply your font selections and close the Font dialog box.

The sizes of the RTC window, as well as the sizes of the windows within RTC, and the fonts used will be saved in the B3638.INI file and reused when you enter RTC the next time.

Step 3. Set the reset value for the supervisor stack pointer and program counter

Step 3. Set the reset value for the supervisor stack pointer and program counter

- 1 Choose the Settings→Emulator Config→Hardware... (ALT, S, E, H) command.
- 2 Under Initial Values for SSP and PC:
 - a. Deselect the Values read from reset vector in memory check box.
 - b. Enter "003000" in the Supervisor Stack Pointer text box.
 - c. Enter "000000" in the Program Counter text box.
- 3 Choose the OK button.

The screenshot shows the 'Hardware Config' dialog box. The 'Initial Values for SSP and PC' section is highlighted, showing the 'Values read from reset vector in memory' checkbox is unchecked. The 'Supervisor Stack Pointer' text box contains '003000' and the 'Program Counter' text box contains '000000'. Other sections include 'Clock Source' (Internal selected), 'Processor data width' (16 bits selected), 'Target memory access' (16 bits selected), 'DTACK Control' (Map interLock for emulation memory selected), 'IACK7 Pin Usage' (Emulator register set determines usage selected), and 'Interrupt 7 Operation' (Emulator register set determines operation selected).

Step 3. Set the reset value for the supervisor stack pointer and program counter

The 6830x emulator requires the supervisor stack pointer to be set to an even address in emulation RAM or in target system RAM.

When you break the emulation processor from the EMULATION RESET state into the RUNNING IN MONITOR state, the supervisor stack pointer is set to the address specified.

You can also set the supervisor stack pointer by modifying the SSP register in the Register window.

Note

Breaking into the monitor from a state other than EMULATION RESET does not cause the supervisor stack pointer to be modified. (The Execution→Reset (ALT, E, E) command places the emulator in the EMULATION RESET state.)

Step 4. Map memory for the demo program

By default, the emulator assumes all memory addresses are in RAM space in your target system. If you wish to load some of your target program in emulation memory, or identify some of your memory addresses as ROM or Guarded, those specifications must be entered in the memory map.

The demo program reserves addresses 400h-2fffh for ROM and 0h-3ffh and 6000h-0ffffh for RAM. Map these address ranges as emulation memory.

Because the BAR and SCR registers are located in the exception vector table (at 0F0H and 0F4H), the exception vector table (0 through 3FFH) is mapped as emulation RAM.

The internal memory space of the 6830x must be mapped as target RAM.

- 1 Choose the Settings→Emulator Config→Memory Map... (ALT, S, E, M) command.
- 2 Enter "0" in the Start text box.
- 3 Tab the cursor to the End text box and enter "3ff".
- 4 Select "eram" in the Type option box.
- 5 Choose the Apply button.
- 6 Enter "400" in the Start text box, enter "0fff" in the End text box, select "erom" in the Type option box, and choose the Apply button.
- 7 Enter "1000" in the Start text box, enter "2fff" in the End text box, select "eram" in the Type option box, and choose the Apply button.
- 8 Enter "6000" in the Start text box and "0ffff" in the End text box, select "eram" in the Type option box, and choose the Apply button.

Step 4. Map memory for the demo program

- 9 Select "tram" in the Default group box. This maps all memory ranges not listed in the Current Map as target system RAM. The 6830x internal memory space is not listed in the Current Map; therefore, it is mapped as target system RAM.

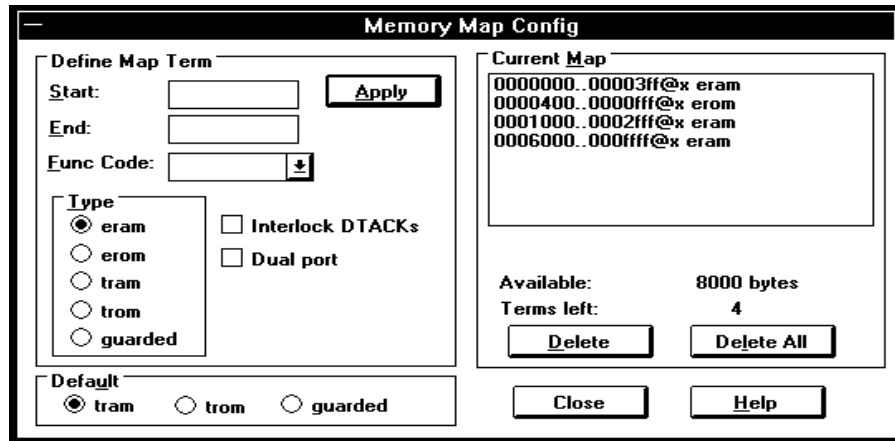

- 10 Choose the Close button.

Step 5. Load the demo program

- 1 Choose the File→Load Object... (ALT, F, L) command.
- 2 Choose the Browse button and select the sample program object file, C:\HP\RTC\M30X\DEMO\SAMPLE\SAMPLE.X (if C:\HP\RTC\M30X was the installation path chosen when installing the debugger software).
- 3 Choose the OK button in the Object File Name dialog box.
- 4 Choose the Load button.

Step 6. Display the source file

To display the sample.c source file starting from the main function:

- 1 If the Source window is not open, double-click on the Source window icon to open the window. Or, choose the Window→Source command.
- 2 From the Source window's *control menu*, choose Search→Function... (ALT, -, R, F) command.
- 3 Select "main".
- 4 Choose the Find button.
- 5 Choose the Close button.
- 6 From the Source window's *control menu*, choose Display→Source Only (ALT, -, D, S) command.

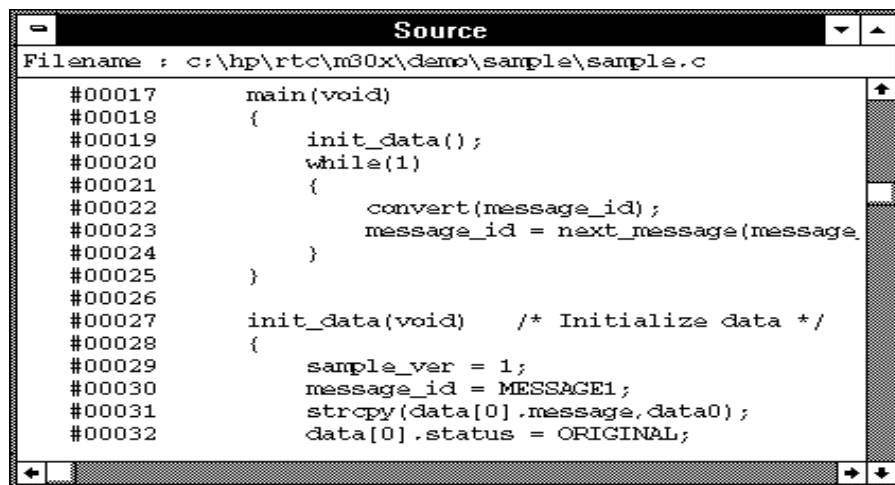

```
Source
Filename : c:\hp\rtc\m30x\demo\sample\sample.c
#00017     main(void)
#00018     {
#00019         init_data();
#00020         while(1)
#00021         {
#00022             convert(message_id);
#00023             message_id = next_message(message
#00024         }
#00025     }
#00026
#00027     init_data(void) /* Initialize data */
#00028     {
#00029         sample_ver = 1;
#00030         message_id = MESSAGE1;
#00031         strcpy(data[0].message, data0);
#00032         data[0].status = ORIGINAL;
```

The window displays sample.c source file, starting from main function.

Step 7. Set a breakpoint

To set a breakpoint on line 22 in sample.c:

- 1 Cursor-select line 22 (that is, move the mouse pointer over line 22 and click the left mouse button).
- 2 Choose the Breakpoint→Set at Cursor (ALT, B, S) command.

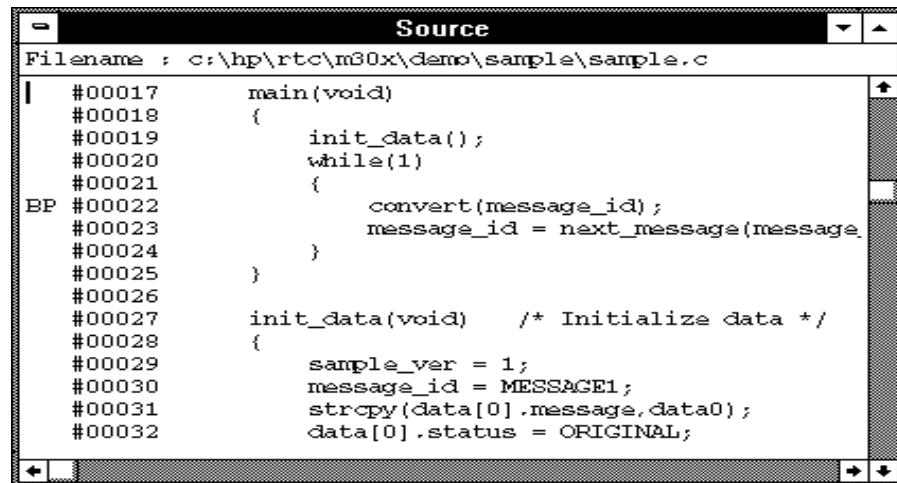

The screenshot shows a window titled "Source" with a file path of "c:\hp\rtc\m30x\demo\sample\sample.c". The code is as follows:

```
#00017 main(void)
#00018 {
#00019     init_data();
#00020     while(1)
#00021     {
BP #00022         convert(message_id);
#00023         message_id = next_message(message
#00024     )
#00025     }
#00026
#00027 init_data(void) /* Initialize data */
#00028 {
#00029     sample_ver = 1;
#00030     message_id = MESSAGE1;
#00031     strcpy(data[0].message, data0);
#00032     data[0].status = ORIGINAL;
```

A vertical bar on the left side of the editor indicates the current line, and the text "BP" is placed to the left of line 22, indicating that a breakpoint has been set there.

Notice that line 22 is marked with "BP" which indicates a breakpoint has been set on the line.

Note

This can be done more quickly by using the pop-up menu available with the right mouse button.

Step 8. Run the demo program

To run the demo program from the transfer address:

- 1 Choose the Execution→Reset (ALT, E, E) command followed by the Execution→Break (ALT, E, B) command to initialize the supervisor stack pointer.
- 2 Choose the Execution→Run... (ALT, E, R) command.
- 3 Select the Start Address option.
- 4 Choose the Run button.

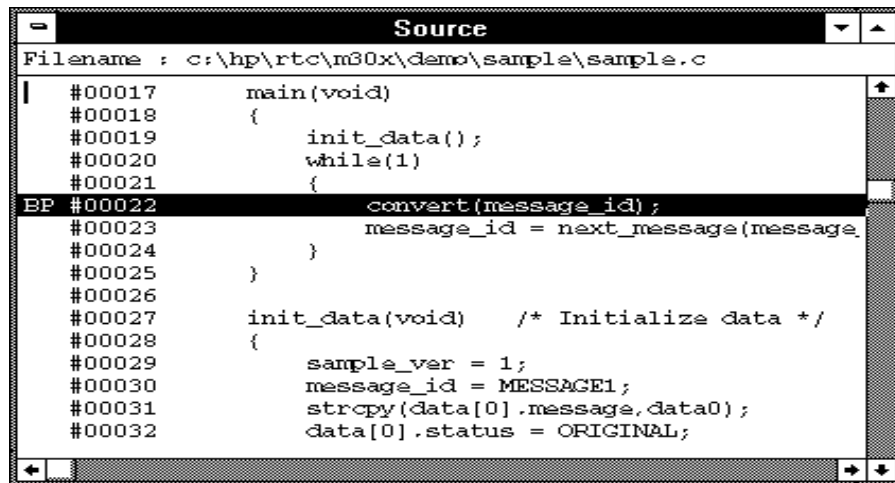

The screenshot shows a window titled "Source" with a filename of "c:\hp\rtc\m30x\demo\sample\sample.c". The code is as follows:

```
#00017    main(void)
#00018    {
#00019        init_data();
#00020        while(1)
#00021        {
BP #00022    convert(message_id);
#00023        message_id = next_message(message
#00024        )
#00025    }
#00026
#00027    init_data(void) /* Initialize data */
#00028    {
#00029        sample_var = 1;
#00030        message_id = MESSAGE1;
#00031        strcpy(data[0].message, data0);
#00032        data[0].status = ORIGINAL;
```

Line 22, which is the first line of the `while` loop, is highlighted in black and labeled "BP #00022".

Notice the demo program runs until line 22. The highlighted line indicates the current program counter.

Step 9. Delete the breakpoint

To delete the breakpoint set on line 22:

- 1** Cursor-select line 22.
- 2** Choose the Breakpoint→Delete at Cursor (ALT, B, D) command.

The "BP" marker disappears in the Source window.

Step 10. Single-step one line

To single-step the demo program from the current program counter:

- Choose the **Execution→Single Step (ALT, E, N)** command. Or, press the **F2** key.

Notice the **C** statement executed and the program counter is at the "convert" function.

Step 11. Single-step 10 lines

To single-step 10 consecutive executable statements from the current PC line:

- 1 Choose the Execution→Step... (ALT, E, S) command.
- 2 Select the Current PC option.
- 3 Enter "10" in the Count text box.

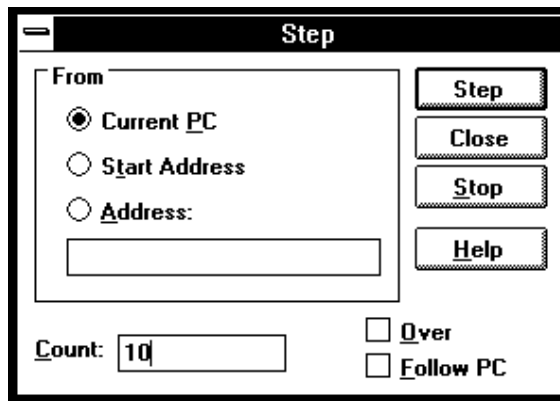

- 4 Choose the Step button. Notice that the step count decrements by one as the program executes step by step. The step count stops at 0.
- 5 Choose the Close button.

Step 12. Display a variable

To display the contents of auto variable `*mes`:

- 1 Drag `*mes` on line 45 in the Source window until it is highlighted.
- 2 Choose the Variable→Edit... (ALT, V, E) command.

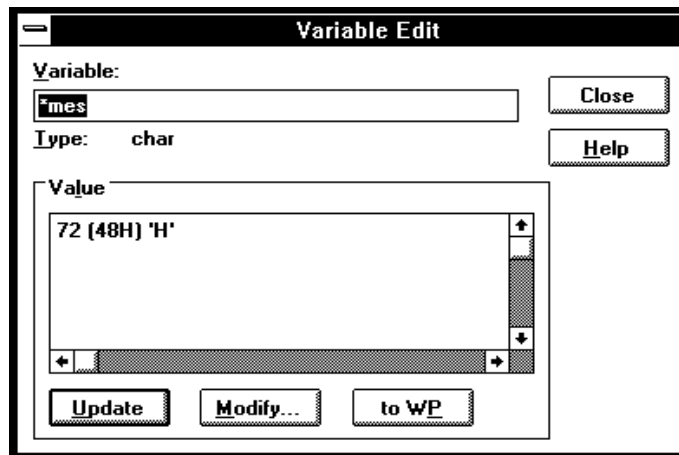

The Variable text box displays `*mes`.

Notice the Value list box displays the contents of `*mes`.

Note

You can only register or display an auto variable as a watchpoint while the program counter is within the function in which the variable name is declared.

Step 13. Edit a variable

To edit the contents of variable "*mes":

- 1 In the Variable Edit dialog box, choose the Modify button.
- 2 Enter "41" in the Value text box.

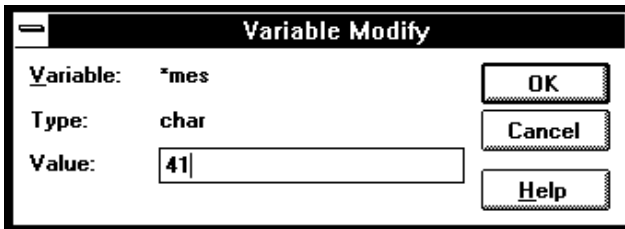

- 3 Choose the OK button.
- 4 Notice the contents of the variable in the Value list box has changed to "41".

Step 14. Monitor a variable in the WatchPoint window

The WatchPoint window lets you define a set of variables that may be looked at and modified often. For these types of variables, using the WatchPoint window is more convenient than using the Variable→Edit... (ALT, V, E) command.

To monitor the variable `*mes` in the WatchPoint window:

- 1 In the Variable Edit dialog box, choose the "to WP" button.
- 2 Choose the Close button.
- 3 Choose the Window→WatchPoint command.

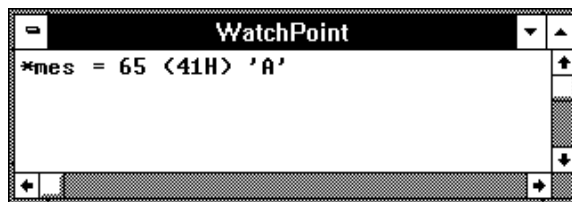

Notice the variable `*mes` has been registered as a watchpoint.

Step 15. Run until return from current function

To execute the program until "convert_case" (the current PC function) returns to its caller:

- 1 Choose the Execution→Run to Caller (ALT, E, T) command.

The program executes until the line that called "convert_case".

- 2 Choose the Execution→Single Step (ALT, E, N) command (or press the F2 key) to go to the line that follows the return from the "convert_case:" function.

Step 16. Step over a function

To step over "change_status":

- Choose the Execution→Step Over (ALT, E, O) command. Or, press the F3 key.

The "change_status" function executes, and the program counter indicates line 41.

Step 17. Run the program to a specified line

To execute the demo program to the first line of "next_message":

- 1 Cursor-select line 63.
- 2 Choose the Execution→Run to Cursor (ALT, E, C) command.

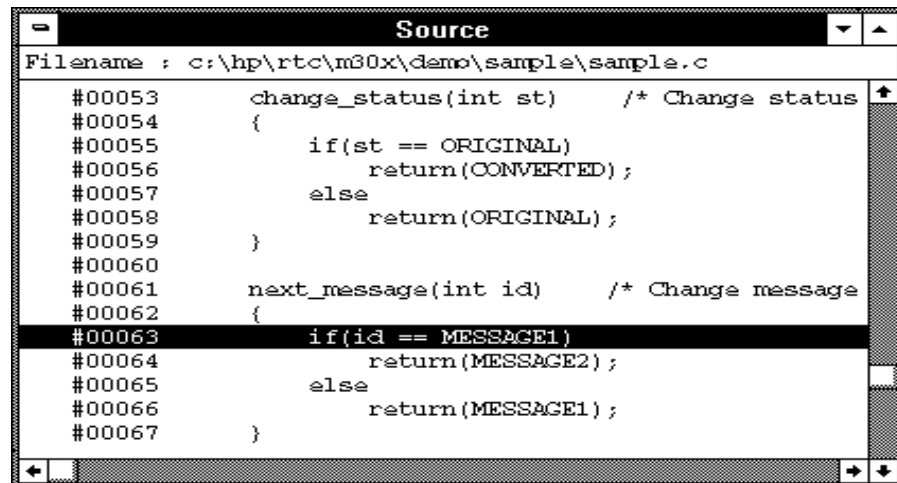

The screenshot shows a window titled "Source" with a file path of "c:\hp\rtc\m30x\demo\sample\sample.c". The code is as follows:

```
#00053  change_status(int st)  /* Change status
#00054  {
#00055      if(st == ORIGINAL)
#00056          return(CONVERTED);
#00057      else
#00058          return(ORIGINAL);
#00059  }
#00060
#00061  next_message(int id)  /* Change message
#00062  {
#00063      if(id == MESSAGE1)
#00064          return(MESSAGE2);
#00065      else
#00066          return(MESSAGE1);
#00067  }
```

Line #00063 is highlighted in the screenshot.

The program executes and stops immediately before line 63.

Step 18. Display register contents

- 1 Choose the Window→Basic Registers command.

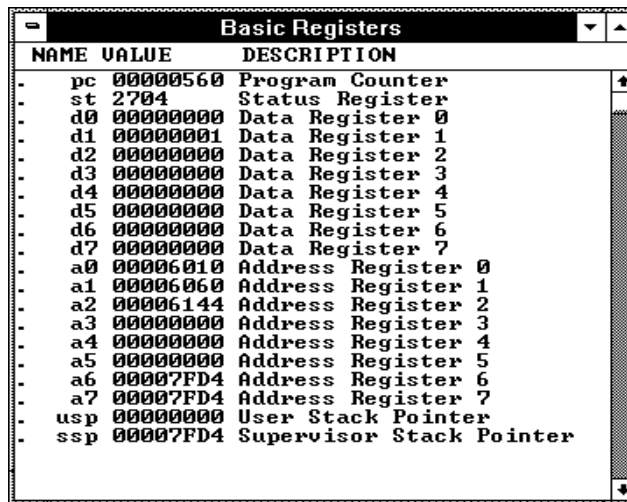

NAME	VALUE	DESCRIPTION
pc	00000560	Program Counter
st	2704	Status Register
d0	00000000	Data Register 0
d1	00000001	Data Register 1
d2	00000000	Data Register 2
d3	00000000	Data Register 3
d4	00000000	Data Register 4
d5	00000000	Data Register 5
d6	00000000	Data Register 6
d7	00000000	Data Register 7
a0	00006010	Address Register 0
a1	00006060	Address Register 1
a2	00006144	Address Register 2
a3	00000000	Address Register 3
a4	00000000	Address Register 4
a5	00000000	Address Register 5
a6	00007FD4	Address Register 6
a7	00007FD4	Address Register 7
usp	00000000	User Stack Pointer
ssp	00007FD4	Supervisor Stack Pointer

The Basic Registers window opens and displays the register contents. The display is updated periodically.

- 2 To see the effects of preventing monitor intrusion (running in real-time mode), choose the RealTime→Monitor Intrusion→Disallowed (ALT, R, T, D) command.

- 3 To run the program, choose the Execution→Run (ALT, E, U) command. Or, press the F5 key.

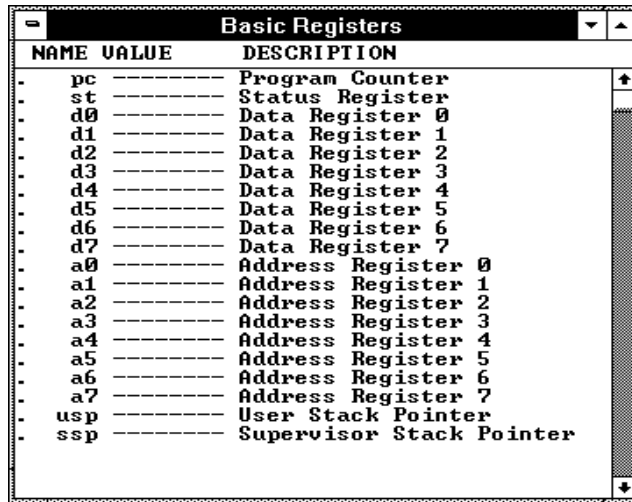

NAME	VALUE	DESCRIPTION
pc	----	Program Counter
st	----	Status Register
d0	----	Data Register 0
d1	----	Data Register 1
d2	----	Data Register 2
d3	----	Data Register 3
d4	----	Data Register 4
d5	----	Data Register 5
d6	----	Data Register 6
d7	----	Data Register 7
a0	----	Address Register 0
a1	----	Address Register 1
a2	----	Address Register 2
a3	----	Address Register 3
a4	----	Address Register 4
a5	----	Address Register 5
a6	----	Address Register 6
a7	----	Address Register 7
usp	----	User Stack Pointer
ssp	----	Supervisor Stack Pointer

Notice that register contents are replaced with "----" in the display. This shows the debugger cannot update the register display. In order for the emulator to update its register display, the emulation monitor must interrupt target program execution while it reads the registers.

- 4 Choose the RealTime→Monitor Intrusion→Allowed (ALT, R, T, A) command to deselect the real-time mode. Notice that the contents of the registers are updated periodically.

Step 19. Trace function flow

- Choose the Trace→Function Flow (ALT, T, F) command.

The Trace window becomes active and displays execution flow as shown below.

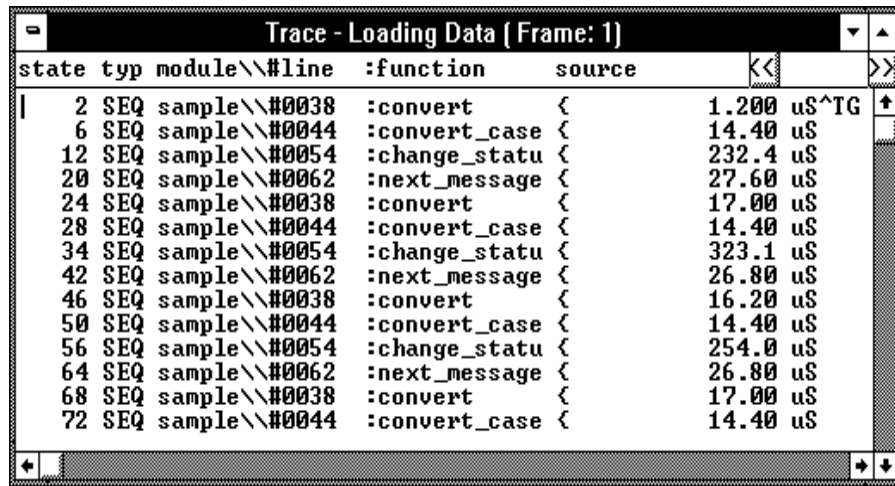

state	typ	module\#line	:function	source		
	2	SEQ sample\#0038	:convert	{	1.200	uS^TG
	6	SEQ sample\#0044	:convert_case	{	14.40	uS
	12	SEQ sample\#0054	:change_statu	{	232.4	uS
	20	SEQ sample\#0062	:next_message	{	27.60	uS
	24	SEQ sample\#0038	:convert	{	17.00	uS
	28	SEQ sample\#0044	:convert_case	{	14.40	uS
	34	SEQ sample\#0054	:change_statu	{	323.1	uS
	42	SEQ sample\#0062	:next_message	{	26.80	uS
	46	SEQ sample\#0038	:convert	{	16.20	uS
	50	SEQ sample\#0044	:convert_case	{	14.40	uS
	56	SEQ sample\#0054	:change_statu	{	254.0	uS
	64	SEQ sample\#0062	:next_message	{	26.80	uS
	68	SEQ sample\#0038	:convert	{	17.00	uS
	72	SEQ sample\#0044	:convert_case	{	14.40	uS

The command traces, and stores in trace memory, only the entry points to functions. This lets you check program execution flow.

If the display you have on screen does not look like the trace list above, from the Trace window's control menu, choose the Display→Source Only (ALT, -, D, S) command.

Step 20. Trace a function's callers

To trace the caller of "next_message":

- 1 Double-click "next_message" in the Trace window or on line 61 in the Source window.
- 2 Choose the Trace→Function Caller... (ALT, T, C) command.

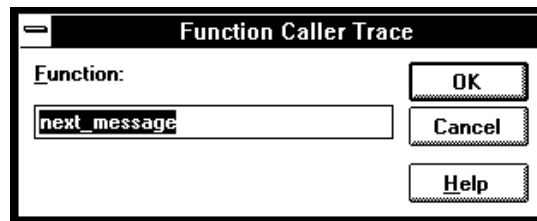

- 3 Choose the OK button.

The Trace window becomes active and displays the caller as shown below.

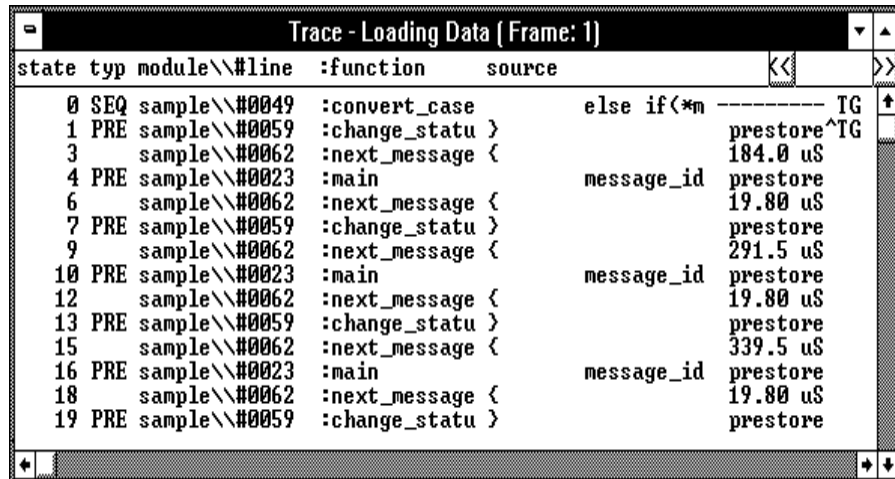

state	typ	module	#line	:function	source
0	SEQ	sample	#0049	:convert_case	else if(*m ----- TG
1	PRE	sample	#0059	:change_statu	} prestore^TG
3		sample	#0062	:next_message	{ 184.0 uS
4	PRE	sample	#0023	:main	message_id prestore
6		sample	#0062	:next_message	{ 19.80 uS
7	PRE	sample	#0059	:change_statu	} prestore
9		sample	#0062	:next_message	{ 291.5 uS
10	PRE	sample	#0023	:main	message_id prestore
12		sample	#0062	:next_message	{ 19.80 uS
13	PRE	sample	#0059	:change_statu	} prestore
15		sample	#0062	:next_message	{ 339.5 uS
16	PRE	sample	#0023	:main	message_id prestore
18		sample	#0062	:next_message	{ 19.80 uS
19	PRE	sample	#0059	:change_statu	} prestore

Step 20. Trace a function's callers

This command stores the first statement of a function and prestores statements that occur before the first statement (notice the state type PRE). The prestored statements show the caller of the function. In the above example, "next_message" is called by line 23 of "main". Because the first statement of "next_message" is prefetched after "change_status", these states are also included in the trace.

Step 21. Trace access to a variable

To trace access to variable "message_id":

- 1 Double-click "message_id" in the Trace window or on line 22 in the Source window.
- 2 Choose the Trace→Variable Access... (ALT, T, V) command.

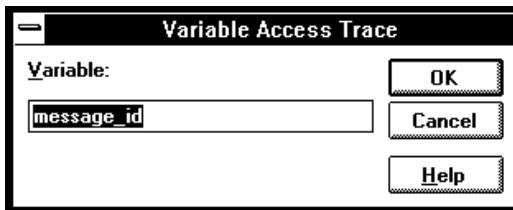

- 3 Choose the OK button.

The Trace window becomes active and displays accesses to "message_id" as shown below.

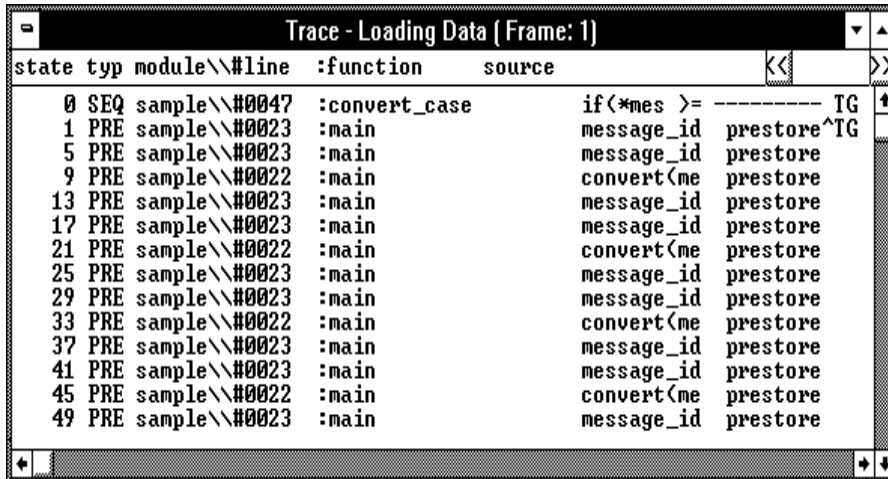

state	typ	module	#line	:function	source
0	SEQ	sample	#0047	:convert_case	if(*mes >= ----- TG
1	PRE	sample	#0023	:main	message_id prestore^TG
5	PRE	sample	#0023	:main	message_id prestore
9	PRE	sample	#0022	:main	convert(me prestore
13	PRE	sample	#0023	:main	message_id prestore
17	PRE	sample	#0023	:main	message_id prestore
21	PRE	sample	#0022	:main	convert(me prestore
25	PRE	sample	#0023	:main	message_id prestore
29	PRE	sample	#0023	:main	message_id prestore
33	PRE	sample	#0022	:main	convert(me prestore
37	PRE	sample	#0023	:main	message_id prestore
41	PRE	sample	#0023	:main	message_id prestore
45	PRE	sample	#0022	:main	convert(me prestore
49	PRE	sample	#0023	:main	message_id prestore

Line 23 displays twice because it accessed "message_id" twice for read and write.

Step 22. Exit the debugger

- 1** Choose the File→Exit (ALT, F, X) command.
- 2** Choose the OK button.

This will end your Real-Time C Debugger session.

If you had problems when using the Getting Started tutorial, refer to the Installation/Service/Terminal Interface User's Guide for Motorola 6830x-Family Emulator/Analyzer, HP 64798.

Part 2

User's Guide

A complete set of task instructions and problem-solving guidelines, with a few basic concepts.

Part 2

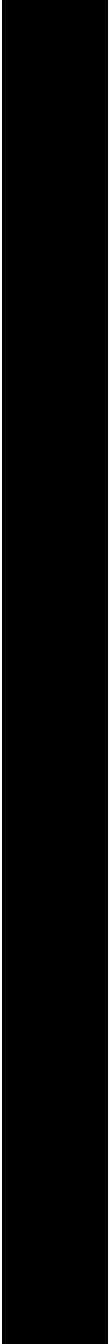



Using the Debugger Interface

Using the Debugger Interface

This chapter contains general information about using the debugger interface.

- How the Debugger Uses the Clipboard
- Debugger Function Key Definitions
- Starting and Exiting the Debugger
- Working with Debugger Windows
- Using Command Files

How the Debugger Uses the Clipboard

Whenever something is selected with the standard windows double-click, it is placed on the clipboard. The clipboard can be pasted into selected fields by clicking the right mouse button.

Double-clicks are also used in the Register and Memory windows to make values active for editing. These double-clicks also copy the current value to the clipboard, destroying anything you might have wanted to paste into the window (for example, a symbol into the memory address field). In situations like this, you can press the CTRL key while double-clicking to prevent the selected value from being copied to the clipboard. This allows you to, for example, double-click on a symbol, CTRL+double-click to activate a register value for editing, and click the right mouse button to paste the symbol value into the register.

Many of the Real-Time C Debugger commands and their dialog boxes open with the clipboard contents automatically pasted in the dialog box. This makes entering commands easy. For example, when tracing accesses to a program variable, you can double-click on the variable name in one of the debugger windows, choose the Trace→Variable Access... (ALT, T, V) command, and click the OK button without having to enter or paste the variable name in the dialog box (since it is has automatically been pasted in the dialog box).

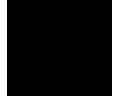

Debugger Function Key Definitions

F1	Accesses context sensitive help. Context sensitive help is available for windows, dialog boxes, and menu items (with Ctrl+F1).
F2	Executes a single source line from the current program counter address (or a single instruction if disassembled mnemonics are mixed with source lines in the Source window).
F3	Same as F2 except when the source line contains a function call (or the assembly instruction makes a subroutine call); in these cases, the entire function (or subroutine) is executed.
F4	Break emulator execution into the monitor. You can use this to stop a running program or break into the monitor from the processor reset state.
F5	Runs the program from the current program counter address.
Shift-F4	Tiles the open debugger windows.
Shift-F5	Cascades the open debugger windows.
F7	Repeats the trace command that was entered last.
Ctrl+F7	Halts the current trace.

Starting and Exiting the Debugger

This section shows you how:

- To start the debugger
- To exit the debugger
- To create an icon for a different emulator

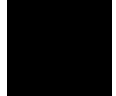

To start the debugger

- Double-click the debugger icon.

Or:

- 1** Choose the File→Run (ALT, F, R) command in the Windows Program Manager.
- 2** Enter the debugger filename, C:\HP\RTC\M30X\B3638.EXE (if C:\HP\RTC\M30X was the installation path chosen when installing the debugger software).
- 3** Choose the OK button.

You can execute a command file when starting the debugger by using the "-C<command_file>" command line option.

To exit the debugger

- 1 Choose the File→Exit (ALT, F, X) command.
- 2 Choose the OK button.

This will end your Real-Time C Debugger session.

To create an icon for a different emulator

- 1 Open the "HP Real-Time C Debugger" group box, or make it active by positioning the mouse in the window and clicking the left button.
- 2 Choose the File→New... (ALT, F, N) command in the Windows Program Manager.
- 3 Select the Program Item option and choose OK.
- 4 In the Description text box, enter the icon description.
- 5 In the Command Line text box, enter the "C:\HP\RTC\M30X\B3638.EXE -T<transport> -E<connectname>" command (if C:\HP\RTC\M30X was the installation path chosen when installing the debugger software). The "-T" and "-E" startup options allow you to bypass the transport and connect name definitions in the B3638.INI file.

<Transport> should be one of the supported transport options (for example, HP-ARPA, RS232C, etc.).

<Connectname> should identify the emulator for the type of transport. For example, if the HP-ARPA transport is used, <connectname> should be the hostname or IP address of the HP 64700; if the RS232C transport is used, <connectname> should be COM1, COM2, etc.

- 6 In the Working Directory text box, enter the directory that contains the debugger program (for example, C:\HP\RTC\M30X).
- 7 Choose the OK button.



Working with Debugger Windows

This section shows you how:

- To open debugger windows
- To copy window contents to the list file
- To change the list file destination
- To change the debugger window fonts
- To set tab stops in the Source window
- To set colors in the Source window

To open debugger windows

- Double-click the icon for the particular window.
- Or, choose the particular window from the Window→ menu.
- Or, choose the Window→More Windows... (ALT, W, M) command, select the window to be opened from the dialog box, and choose the OK button.

To copy window contents to the list file

- From the window's control menu, choose the Copy→Windows (ALT, -, P, W) command.

The information shown in the window is copied to the destination list file.

You can change the name of the destination list file by choosing the Copy→Destination... (ALT, -, P, D) command from the window's control menu or by choosing the File→Copy Destination... (ALT, F, P) command.

To change the list file destination

- Choose the File→Copy Destination... (ALT, F, P) command, and select the name of the new destination list file.
- Or, from the window's control menu, choose the Copy→Destination... (ALT, -, P, D) command, and select the name of the new destination list file.

Information copied from windows will be copied to the selected destination file until the destination list file name is changed again.

List file names have the ".LST" extension.

To change the debugger window fonts

- 1 Choose the Settings→Font (ALT, S, F) command.
- 2 Select the font, font style, and size. Notice that the Sample box previews the selected font.
- 3 Choose the OK button.

To set tab stops in the Source window

- 1 Choose the Settings→Tabstops (ALT, S, T) command.
- 2 Enter the tab width. This width is also used for source lines in the trace window.
- 3 Choose the OK button.

The tab width must be between 1 and 20.

To set colors in the Source window

- 1 Exit the RTC interface and find the initialization file (B3638.INI). It should be in the directory where you installed the RTC product (C:\HP\RTC\, by default).
- 2 Edit the initialization file to find the "color" entry. You will see:

```
[Color]  
ColorMode=ON|OFF  
ColorPc=<color>  
ColorSource=<color>  
ColorMne=<color>
```

Where: <color> may be any of the following: RED, GREEN, BLUE, YELLOW, PINK, PURPLE, AQUA, ORANGE, SLATE, or WHITE.

- The <color> entry may be in upper-case or lower-case letters.
- When ColorMode=ON, these are the default colors:
 - ColorPC=GREEN
 - ColorSource=RED
 - ColorMne=BLUE
- The default color is black if an option is given a null value.
- The options under [Color] set colors as follows:
 - ColorPc sets the color of the line of the current program counter.
 - ColorSource sets the color of the line numbers of source lines.
 - ColorMne sets the color of the address of all mnemonic lines.

Note

If you have set ColorMode=ON while using a monochrome display, you may see no line numbers in the Source window. Items that will be presented in color on a color display may not be seen at all on a monochrome display.

Using Command Files

This section shows you how:

- To create a command file
- To execute a command file
- To create buttons that execute command files

A command file is an ASCII text file containing one or more debugger commands. All the commands are written in a simple format, which makes editing easy. The debugger commands used in command files are the same as those used with break macros. For details about the format of each debugger command, refer to the "Reference" information.

To create a command file

- 1** Choose the File→Command Log→Log File Name... (ALT, F, C, N) command.
- 2** Enter the command file name.
- 3** Choose the File→Command Log→Logging ON (ALT, F, C, O) command.
- 4** Choose the commands to be stored in the command file.
- 5** Once the commands have been completed, choose the File→Command Log→Logging OFF (ALT, F, C, F) command.

Command files can also be created by saving the emulator configuration.

To execute a command file

- 1 Choose the File→Run Cmd File... (ALT, F, R) command.
- 2 Select the command file to be executed.
- 3 Choose the Execute button.

You can execute command files that have been created by logging commands.

Also, emulator configurations can be restored by executing the associated command file.

You can execute a command file when starting the debugger by using the "-C<command_file>" command line option.

Example

Command File Being Executed

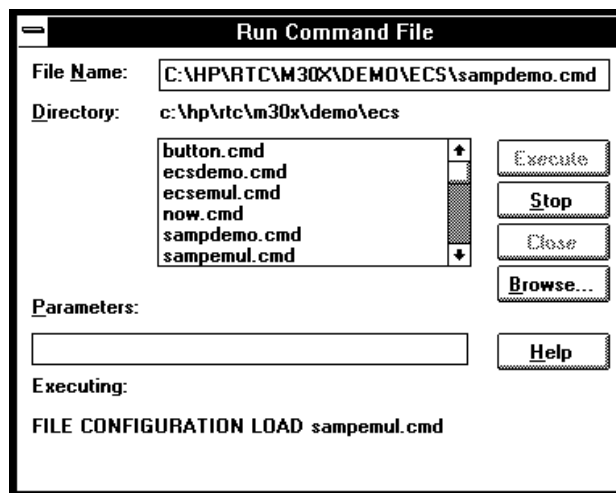

To create buttons that execute command files

- 1** Activate the Button window by clicking on the Button window icon or by choosing the Window→Button command.
- 2** From the Button window's control menu, choose the Edit... (ALT, -, E) command.
- 3** In the Command text box, enter "FILE COMMAND", a space, and the name of the command file to be executed.
- 4** Enter the button label in the Name text box.
- 5** Choose the Add button.
- 6** Choose the Close button.

Once a button has been added, you can click on it to run the command file.

You can also set up buttons to execute other debugger commands.



Configuring the Emulator

Configuring the Emulator

This chapter contains information about configuring the emulator.

- Setting the Hardware Options
- Mapping Memory
- Using the EMSIM Registers
- Verifying the Emulator Configuration
- Setting Up the BNC Port
- Saving and Loading Configurations
- Setting the Real-Time Options

Setting the Hardware Options

This section shows you how:

- To select the emulator clock source
- To select the processor data bus width
- To specify the target memory access size
- To specify the TRAP number for software breakpoints
- To enable or disable breaks on writes to ROM
- To enable or disable the target /BERR signal
- To enable or disable freeze of peripherals during monitor execution
- To enable or disable buffering of the chip-select lines to the target system
- To enable or disable buffering of the function-code lines to the target system
- To enable or disable buffering of the read/write line to the target system
- To enable or disable buffering of the strobe lines to the target system
- To enable or disable buffering of the write-enable lines to the target system
- To enable or disable drive of background monitor cycles to the target system
- To enable or disable driving /DTACK high (deassert) after each assertion
- To enable or disable target system interrupts
- To enable or disable tracing of DMA cycles
- To specify initial values for the SSP and PC
- To specify control of the /DTACK signal
- To specify the use of the /IACK7/PB0 pin
- To specify operation during an Interrupt 7 occurrence



To select the emulator clock source

- 1 Choose the Settings→Emulator Config→Hardware... (ALT, S, E, H) command.
- 2 Select either the Internal or External option for the emulator clock source.
- 3 Choose the OK button to exit the Hardware Config dialog box.

The emulator can operate from either the target system clock (External) or from a clock module installed on the emulator probe (Internal). On the emulator probe, you can install either an oscillator or a crystal. The target system clock (if used) must be supplied from an oscillator.

By default, a 20-MHz oscillator is installed on the emulator probe. You can remove this oscillator and install a different clock source, if desired. A wide variety of clock selections can be made when using this emulator. For specific details of how to select and install a different clock module, refer to the Installation/Service/Terminal Interface manual supplied with the emulator.

Note

Changing the clock source selection resets the emulator.

To select the processor data bus width

- 1 Choose the Settings→Emulator Config→Hardware... (ALT, S, E, H) command.
- 2 Select either the 8 bits or 16 bits option for the Processor data width.
- 3 Choose the OK button to exit the Hardware Config dialog box.

The Processor data width selection is only used when the emulator is operating with the demo board. This lets you choose whether the demo board will operate as if it has an 8-bit or 16-bit bus width.

When the emulator is operating with a target system, the emulator automatically selects the appropriate data bus width, using the target system BUSW pin.

To specify the target memory access size

- 1 Choose the Settings→Emulator Config→Hardware... (ALT, S, E, H) command.
- 2 Select either the 8 bits or 16 bits option for the Target memory access.
- 3 Choose the OK button to exit the Hardware Config dialog box.

All target system memory accesses occur in the specified size.

If the processor bus width is set to 8 bits, either by the BUSW pin or by the 8 bits Processor data width selection in the Hardware Config dialog box, target memory will be accessed in bytes regardless of the selection you make here.

To specify the TRAP number for software breakpoints

- 1** Choose the Settings→Emulator Config→Hardware... (ALT, S, E, H) command.
- 2** Enter a number from 0 to 0fh in the "Trap Number for Software breakpoint" text box.
- 3** Choose the OK button to exit the Hardware Config dialog box.

When breakpoints are set, the program opcodes are replaced with the specified TRAP instruction. The number indicates the exception vector to use in processing the TRAP.

You should select a trap number that is not used by your program code.

Note

Changing the TRAP instruction number cancels all the current breakpoints. Any breakpoints defined in target memory must be deleted by using one of the breakpoint commands.

To enable or disable breaks on writes to ROM

- 1** Choose the Settings→Emulator Config→Hardware... (ALT, S, E, H) command.
- 2** Select or deselect the Enable break on write to ROM check box.
- 3** Choose the OK button to exit the Hardware Config dialog box.

When the check box is selected, a running program breaks into the monitor when it writes to a location mapped as ROM.

When the check box is deselected, program writes to locations mapped as ROM do not cause breaks into the monitor.

In either case, writes to RAM hardware that is mapped as ROM will modify the memory content.



To enable or disable the target /BERR signal

- 1** Choose the Settings→Emulator Config→Hardware... (ALT, S, E, H) command.
- 2** Select or deselect the Enable Target BERR Signal check box.
- 3** Choose the OK button to exit the Hardware Config dialog box.

When the check box is selected, the target system /BERR and the emulator /BERR signals are tied together.

When the check box is deselected, the target system /BERR and the emulator /BERR signals are disconnected. The 6830x can still generate /BERR, however the target system will not see this signal. The emulator will also not respond to target system bus errors.

To enable or disable freeze of peripherals during monitor execution

- 1 Choose the Settings→Emulator Config→Hardware... (ALT, S, E, H) command.
- 2 Select or deselect the Enable Background Freeze check box.
- 3 Choose the OK button to exit the Hardware Config dialog box.

Selecting the check box makes the emulator assert the processor /FRZ line when the emulator is executing the background monitor program. This freezes the activity of selected processor peripherals. In this case, no interrupts can be serviced.

Deselecting the check box allows all processor peripherals, including a coprocessor, to run when the emulator is executing in the background monitor.



To enable or disable buffering of the chip-select lines to the target system

- 1** Choose the Settings→Emulator Config→Hardware... (ALT, S, E, H) command.
- 2** Select or deselect the Enable buffer of CS lines to target check box.
- 3** Choose the OK button to exit the Hardware Config dialog box.

When the check box is deselected (default), the emulator will have the least impact on timing and V_{OH} within the target system, but the emulator will add some capacitance to the chip-select lines.

When the check box is selected, chip-select performance will improve if capacitance is an issue, but system timing may be degraded by the delay in the buffer circuit, and V_{OH} may be lowered. In a CMOS target system, the low V_{OH} may degrade system performance.

To enable or disable buffering of the function-code lines to the target system

- 1 Choose the Settings→Emulator Config→Hardware... (ALT, S, E, H) command.
- 2 Select or deselect the Enable buffer of FC lines to target check box.
- 3 Choose the OK button to exit the Hardware Config dialog box.

When the check box is deselected (default), the emulator will have the least impact on timing and V_{OH} within the target system, but the emulator will add some capacitance to the function-code lines.

When the check box is selected, function-code performance will improve if capacitance is an issue, but system timing may be degraded by the delay in the buffer circuit, and V_{OH} may be lowered. In a CMOS target system, the low V_{oh} may degrade system performance.



To enable or disable buffering of the read/write line to the target system

- 1** Choose the Settings→Emulator Config→Hardware... (ALT, S, E, H) command.
- 2** Select or deselect the Enable buffer of R/W line to target check box.
- 3** Choose the OK button to exit the Hardware Config dialog box.

When the check box is deselected (default), the emulator will have the least impact on timing and V_{OH} within the target system, but the emulator will add some capacitance to the read/write line.

When the check box is selected, read/write performance will improve if capacitance is an issue, but system timing may be degraded by the delay in the buffer circuit, and V_{OH} may be lowered. In a CMOS target system, the low V_{oh} may degrade system performance.

To enable or disable buffering of the strobe lines to the target system

- 1 Choose the Settings→Emulator Config→Hardware... (ALT, S, E, H) command.
- 2 Select or deselect the Enable buffer of strobe lines to target check box.
- 3 Choose the OK button to exit the Hardware Config dialog box.

When the check box is deselected (default), the emulator will have the least impact on timing and V_{OH} within the target system, but the emulator will add some capacitance to the strobe lines (address strobe, data strobe, and /IACK7 strobe).

When the check box is selected, strobe performance will improve if capacitance is an issue, but system timing may be degraded by the delay in the buffer circuit, and V_{OH} may be lowered. In a CMOS target system, the low V_{oh} may degrade system performance.



To enable or disable buffering of the write-enable lines to the target system

- 1** Choose the Settings→Emulator Config→Hardware (ALT, S, E, H) command.
- 2** Select or deselect the Enable buffer of WE lines to target check box.
- 3** Choose the OK button to exit the Hardware Config dialog box.

When the check box is deselected (default), the emulator will have the least impact on timing and V_{OH} within the target system, but the emulator will add some capacitance to the write-enable lines.

When the check box is selected, write-enable performance will improve if capacitance is an issue, but system timing may be degraded by the delay in the buffer circuit, and V_{OH} may be lowered. In a CMOS target system, the low V_{oh} may degrade system performance.

To enable or disable drive of background monitor cycles to the target system

- 1 Choose the Settings→Emulator Config→Hardware... (ALT, S, E, H) command.
- 2 Select or deselect the Enable drive of BKG cycles to target check box.
- 3 Choose the OK button to exit the Hardware Config dialog box.

When the check box is deselected (default), chip-select lines will not be driven to the target system during monitor program execution, and all strobes (address, data, /IACK7, etc.) will be hidden from the target system.

When the check box is selected, chip-select lines will be driven to the target system during monitor program execution, and all write transactions will be changed to read transactions on the read/write line. Select the check box if you need to keep a watchdog timer alive on your target system.



To enable or disable driving /DTACK high (deassert) after each assertion

- 1** Choose the Settings→Emulator Config→Hardware... (ALT, S, E, H) command.
- 2** Select or deselect the Enable DTACK drive high check box.
- 3** Choose the OK button to exit the Hardware Config dialog box.

This selection only applies when the /DTACK signal is supplied by the emulator.

If selected (default), the emulator drives the /DTACK signal high for 5 to 10 ns after each /DTACK from the emulator. This does not affect /DTACK from the target system or from the chip selects. This ensures that /DTACK will be deasserted before the next cycle so it will be used properly.

If deselected and your target system is running at a high processor speed, /DTACK may be recognized because it was asserted by a previous cycle. This causes the emulator to run at 0 wait states.

To enable or disable target system interrupts

- 1 Choose the Settings→Emulator Config→Hardware... (ALT, S, E, H) command.
- 2 Select or deselect the Enable target system interrupts check box.
- 3 Choose the OK button to exit the Hardware Config dialog box.

When the check box is selected, the emulator detects interrupts from the target system while running the user program. Target system interrupts are ignored when the emulator is running in the background monitor.

When the check box is deselected, the emulator ignores any interrupt from the target system.

To enable or disable tracing of DMA cycles

- 1 Choose the Settings→Emulator Config→Hardware... (ALT, S, E, H) command.
- 2 Select or deselect the Enable tracing of DMA cycles check box.
- 3 Choose the OK button to exit the Hardware Config dialog box.

When the check box is deselected (default), no DMA cycles are included in the activity captured during an analyzer trace. This reserves trace memory for storage of executions of the high level target program code.

When the check box is selected, DMA cycles will be included with any other activity captured during an analyzer trace. Traces of DMA cycles may not be as accurate as traces of high level target code because of differences in the timing of the DMA cycles and the timing of target program cycles. In the analyzer, you can qualify a trace to capture only DMA cycles, if desired.

To specify initial values for the SSP and PC

- 1** Choose the Settings→Emulator Config→Hardware... (ALT, S, E, H) command.
- 2** Select or deselect the Values read from reset vector in memory check box.
- 3** Choose the OK button to exit the Hardware Config dialog box.

Normally, if you run the emulator from reset, the processor fetches the values for the SSP and PC from the reset vector table (the SSP at offset 0 and the PC at offset 4). There are cases where the SSP and PC values cannot be fetched from the reset vector table. For example, if you reset the emulator, break to the emulation monitor, and then run the emulator, the SSP and PC values will not be read from the reset vector table. In these cases, the SSP and PC values will be read from the values you enter here.

If you select the Values read from reset vector in memory check box (default), the emulation microprocessor will initialize its Supervisor Stack Pointer and Program Counter with values obtained from the reset vector.

If you deselect the Values read from reset vector in memory check box, the supervisor stack pointer and program counter will be initialized with the values you type into the Supervisor Stack Pointer and Program Counter text boxes.

To specify control of the /DTACK signal

- 1 Choose the Settings→Emulator Config→Hardware... (ALT, S, E, H) command.
- 2 Select one of the four entries within the DTACK Control box.
- 3 Choose the OK button to exit the Hardware Config dialog box.

If you select the Map interlock for Emulation memory entry (default), the emulator will refer to the memory map and the /DTACK specifications defined there for each address range.

If you select Target DTACK always, the emulator will ignore the /DTACK specifications in the memory map and use the /DTACK signal from the target system for all activity. In this mode, the /DTACK signal from the target system will even be used during monitor program execution. Choose (Enable driving backgrnd cycles to target) if you are going to use the monitor because the target system sends no /DTACK signal during monitor execution.

If you select Emul. DTACK always, 0 wait states, the emulator will ignore the /DTACK specifications in the memory map and use the /DTACK signal from the emulator for all activity. Choose 0 wait states for fastest system performance.

If you select Emul. DTACK always, 1 wait state, the emulator will ignore the /DTACK specifications in the memory map and use the /DTACK signal from the emulator for all activity. Choose 1 wait state to slow the system if you are having trouble with target system startup.

To specify the use of the /IACK7/PB0 pin

- 1** Choose the Settings→Emulator Config→Hardware... (ALT, S, E, H) command.
- 2** Select one of the three entries within the IACK7 Pin Usage control box.
- 3** Choose the OK button to exit the Hardware Config dialog box.

This selection tells the emulator how the target system uses the /IACK7/PB0 pin. If the pin is /IACK7, the emulator will block it when executing the monitor program if you choose not to "Enable driving backgrnd cycles to target" in this Hardware Config dialog box. If the pin is PB0, it is never blocked.

If you select Emulator register set determines usage, the Port B Control Register PBCNT in the emulation microprocessor determines the use of the /IACK7/PB0 pin. The emulator will read bit 0 of the PBCNT register to determine whether or not to block this pin when executing the monitor program.

If you select Use IACK7/PB0 pin as IACK7, this tells the emulator that the pin is being used as /IACK7. When the emulator is executing the monitor program, it may block this pin.

If you select Use IACK7/PB0 pin as PB0, this tells the emulator that the pin is being used as PB0. The emulator will not block the signal on this pin during any execution.

To specify operation during an Interrupt 7 occurrence

- 1 Choose the Settings→Emulator Config→Hardware... (ALT, S, E, H) command.
- 2 Select one of the four entries within the Interrupt 7 Operation control box.
- 3 Choose the OK button to exit the Hardware Config dialog box.

This selection tells the emulator how the target system receives and processes interrupts. This way, the emulator can process interrupts correctly.

If you select Emulator register set determines operation, this tells the emulator that the Global Interrupt Mode Register GIMR in the emulation microprocessor determines the method of servicing an Interrupt 7 request. In this case, the emulator will use the value in the GIMR register to process interrupts.

If you select Normal mode of operation, the emulator will use the values of /IPL2 through /IPL0 to determine the interrupt level and to process it.

If you select Dedicated level mode of operation, the emulator will detect /IRQ7, /IRQ6, and /IRQ1 to recognize interrupt requests and process them. The three lines are programmed to be level sensitive.

If you select Dedicated edge mode of operation, the emulator will detect /IRQ7, /IRQ6, and /IRQ1 to recognize interrupt requests and process them. The three lines are programmed to be edge sensitive.



Mapping Memory

This section shows you how:

- To map memory
-

To map memory

- 1** Choose the Settings→Emulator Config→Memory Map... (ALT, S, E, M) command.
- 2** Specify the starting address in the Start text box.
- 3** Specify the end address in the End text box.
- 4** If necessary, select the function code from the Function Code drop-down list.
- 5** Select the memory type in the Type option box.
- 6** Select or deselect Interlock DTACKs for the mapped range.
- 7** Select or deselect Dual port for the mapped range.
- 8** Choose the Apply button.
- 9** Repeat steps 2 through 8 for each range to be mapped.
- 10** Choose the Close button to exit the Memory Map dialog box.

You can map up to 8 address ranges (map terms). The minimum amount of emulation memory that can be allocated to a range varies between 512 and 1024 bytes, depending on the capacity of the memory board used.

It is only necessary to specify *function codes* when mapping *overlapping ranges* for different memory spaces. When mapping overlapping ranges, you can only select function codes that haven't already been selected for previously mapped ranges.

You can specify one of the following memory types for each map term:

eram	Specifies "emulation RAM".
erom	Specifies "emulation ROM".
tram	Specifies "target RAM".
trom	Specifies "target ROM".
guarded	Specifies "guarded memory".

When breaks on writes to ROM are enabled in the emulator configuration, any access from the user program to any memory area mapped as ROM stops the emulator. The content of RAM hardware mapped as ROM will be modified by a write to ROM.

For non-mapped memory areas, select any of the memory types in the Default option box.

Note that the internal memory space of the 6830x must be mapped as target RAM. The BAR and SCR registers (located at 0F0H and 0F4H in the exception vector table) may be mapped as emulation RAM, but you should use the register commands to modify or examine these locations.

If you select Interlock DTACKs, Data Transfer Acknowledge will only be recognized if it is received from the target system. If you are executing the background monitor, the target system MUST provide a /DTACK signal to terminate monitor cycles.

If you deselect Interlock DTACKS, emulation memory and background monitor cycles are terminated by a /DTACK signal generated by the emulator.



Chapter 3: Configuring the Emulator
Mapping Memory

If you select Dual port, the associated address range will be stored in one or more of the built-in 8-Kbyte blocks of dual-port emulation memory. If you deselect Dual port, the associated address range will be stored in one of the SIMM memory modules installed on the emulators's run-control probe, if available.

You should map all memory ranges used by your programs before loading programs into memory.

To delete a map term, first select it in the Map list box; then, choose the Delete button.

Example

To map addresses 6000h through 0ffffh as an emulation RAM having "X" function code, specify the mapping term as shown below.

The image shows a dialog box titled "Define Map Term". It contains the following fields and options:

- Start:** A text box containing "6000".
- End:** A text box containing "0fff".
- Func Code:** A dropdown menu showing "X".
- Apply:** A button to the right of the Start and End fields.
- Type:** A group box containing five radio buttons: "eram" (selected), "erom", "tram", "trom", and "guarded".
- Interlock DTACKs:** An unchecked checkbox.
- Dual port:** An unchecked checkbox.

Choose the Apply button to register the current map term.

Then, choose the Close button to quit mapping.

Using the EMSIM Registers

This section shows you how:

- To view the SIM register differences
- To synchronize to the 6830x SIM registers
- To synchronize to the EMSIM registers
- To reset the EMSIM registers to processor defaults

The 6830x processor contains a System Integration Module (SIM) which has the external bus interface, 4 chip selects, and other circuitry to reduce external logic in a typical microprocessor system. The SIM can be programmed or configured in a variety of ways to suit the need of various systems.

EMSIM registers in the emulator

The 6830x processor contains a System Integration Module (SIM) which has the external bus interface, 4 chip selects, and other circuitry to reduce external logic in a typical microprocessor system. The SIM can be programmed or configured in a variety of ways to suit the need of various systems.

The 6830x emulator contains circuitry that accommodates the flexibility of the SIM and maintains consistent emulation features.

The 6830x SIM is configured through the registers in the SIM register class; these registers control how the 6830x uses external signal lines to access memory.

The emulator is configured through the registers in the EMSIM register class. These registers control how the emulator interprets the signals from the 6830x when accessing emulation memory and passing information to the analysis trace.

Normally, the SIM and EMSIM registers should be programmed with the same values so they will be working together.



Chapter 3: Configuring the Emulator

Using the EMSIM Registers

Normally, the emulator is programmed through the EMSIM registers to match the programming of the 6830x SIM as it will exist after all of the boot-up configuration is complete. This programming can be done before the boot-up code is run. In fact, the programming of the EMSIM registers is part of the configuration, and will be loaded along with the memory map and other configuration items when a configuration file is loaded.

The default programming of the EMSIM registers matches the reset values of the 6830x SIM (refer to the Motorola *MC6830x User's Manual* for specific values).

Note that the emulator is programmed solely from the EMSIM register set and is therefore static with respect to the application program. No attempt is made to update the programming of the emulator by tracking instructions that will program the 6830x SIM.

To view the SIM register differences

- 1 Choose the Settings→Emulator Config→Information... (ALT, S, E, I) command.
- 2 Select "Show differences for M6830x and emsim registers" from the Synchronize SIM registers list.
- 3 Choose the Apply/Results button to display the differences in the viewing area.

To synchronize to the 6830x SIM registers

- 1 Choose the Settings→Emulator Config→Information... (ALT, S, E, I) command.
- 2 Select "Synchronize from 30x sim regs, copy to emsim regs" from the Synchronize SIM registers list.
- 3 Choose the Apply/Results button.

This is useful if initialization code that configures the 6830x SIM exists, but you don't know what its values are. In this case, you can use the default configuration, run from reset to execute the initialization code, and synchronize the EMSIM registers to match the 6830x SIM.

To synchronize to the EMSIM registers

- 1** Choose the Settings→Emulator Config→Information... (ALT, S, E, I) command.
- 2** Select "Synchronize from emsim regs, copy to 30x registers" from the Synchronize SIM registers list.
- 3** Choose the Apply/Results button.

The emsim register values are copied to the 6830x registers automatically each time a break to the monitor from emulation reset occurs. Copying the emsim registers ensures that the 6830x is prepared to properly access memory when a program is downloaded to the emulator.

To reset the EMSIM registers to processor defaults

- 1** Choose the Settings→Emulator Config→Information... (ALT, S, E, I) command.
- 2** Select "Default the emsim register set" from the Synchronize SIM registers list.
- 3** Choose the Apply/Results button.

This resets the EMSIM registers to the processor's default (power-up) values.

Verifying the Emulator Configuration

This section shows you how:

- To check for configuration inconsistencies
- To check emulator clock setup
- To display information about chip selects
- To display information about bus interface ports
- To display information about the memory map
- To display information about the reset mode configuration
- To display assembly code for setting up the SIM



To check for configuration inconsistencies

- 1** Choose the Settings→Emulator Config→Information... (ALT, S, E, I) command.
- 2** Select "Check emulator configuration" from the Config and SIM Programming Info. list.
- 3** Choose the Display Info. button to display the information in the viewing area.

This command:

- Checks for inconsistencies between the reset mode configuration value and the EMSIM registers.
- Compares corresponding values in the SIM and EMSIM register sets.

To check emulator clock setup

- 1 Choose the Settings→Emulator Config→Information... (ALT, S, E, I) command.
- 2 Select "Emulator clock, CLKOUT, & MODCK information" from the Config and SIM Programming Info. list.
- 3 Choose the Display Info. button to display the information in the viewing area.

This command:

- Checks whether the clock is internal (supplied from a plug-in module on the emulator probe) or external (supplied from the target system).
- Checks the type of hardware module supplying the clock signal.
- Checks the clock frequency.

To display information about chip selects

- 1 Choose the Settings→Emulator Config→Information... (ALT, S, E, I) command.
- 2 Select "Chip selects in SIM (processor) registers" or "Chip selects in EMSIM (emulator) registers" from the Config and SIM Programming Info. list.
- 3 Choose the Display Info. button to display the information in the viewing area.

The resulting display shows how the chip selects are assigned, the base address of each, and other information from the option register.

To display information about bus interface ports

- 1 Choose the Settings→Emulator Config→Information... (ALT, S, E, I) command.
- 2 Select "Bus interface A ports in SIM (processor) regs", "Bus interface A ports in EMSIM (emulator) regs", "Bus interface B ports in SIM (processor) regs", "Bus interface B ports in EMSIM (emulator) regs", "Bus interface N ports in SIM (processor) regs", or "Bus interface N ports in EMSIM (emulator) regs" from the Config and SIM Programming Info. list.
- 3 Choose the Display Info. button to display the information in the viewing area.

The resulting display shows the pin assignments for Port A, Port B, or Port N, as selected.

To display information about the memory map

- 1 Choose the Settings→Emulator Config→Information... (ALT, S, E, I) command.
- 2 Select "Memory map & correlation with CSs, etc..." from the Config and SIM Programming Info. list.
- 3 Choose the Display Info. button to display the information in the viewing area.

The resulting display shows detailed information about the memory map.

To display information about the reset mode configuration

- 1 Choose the Settings→Emulator Config→Information... (ALT, S, E, I) command.
- 2 Select "Reset mode configuration value and operation" from the Config and SIM Programming Info. list.
- 3 Choose the Display Info. button to display the information in the viewing area.

The resulting display shows the data bus size and global chip select memory access size.

To display assembly code for setting up the SIM

- 1 Choose the Settings→Emulator Config→Information... (ALT, S, E, I) command.
- 2 Select "Assembly listing matching current EMSIM registers" from the Config and SIM Programming Info. list.
- 3 Choose the Display Info. button to display the information in the viewing area.

The resulting display shows the assembly language program that will initialize the processor as defined by the current EMSIM register contents.

Setting Up the BNC Port

This section shows you how:

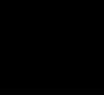
- To output the trigger signal on the BNC port
 - To receive an arm condition input on the BNC port
- 

To output the trigger signal on the BNC port

- Choose the Settings→BNC→Outputs Analyzer Trigger (ALT, S, B, O) command.

The HP 64700 Series emulators have a BNC port for connection with external devices such as logic analyzers or oscilloscopes.

This command enables the trigger signal from the internal analyzer to be fed to external devices.

To receive an arm condition input on the BNC port

- Choose the Settings→BNC→Input to Analyzer Arm (ALT, S, B, R) command.

The HP 64700 Series emulators have a BNC port for connection with external devices such as logic analyzers or oscilloscopes.

This command allows an external trigger signal to be used as an arm (enable) condition for the internal analyzer.

Saving and Loading Configurations

This section shows you how:

- To save the current emulator configuration
- To load an emulator configuration

To save the current emulator configuration

- 1 Choose the File→Save Emulator Config... (ALT, F, V) command.
- 2 In the file selection dialog box, enter the name of the file to which the emulator configuration will be saved.
- 3 Choose the OK button.

This command saves the current hardware, memory map, and monitor settings to a command file.

Saved emulator configuration files can be loaded later by choosing the File→Load Emulator Config... (ALT, F, E) command or by choosing the File→Run Cmd File... (ALT, F, R) command.

See Also

File→Save Emulator Config... (ALT, F, V) in the "Menu Bar Commands" section of the "Reference" information.

To load an emulator configuration

- 1 Choose the File→Load Emulator Config... (ALT, F, E) command.
- 2 Select the name of the emulator configuration command file to load from the file selection dialog box.
- 3 Choose the OK button.

This command lets you reload emulator configurations that have previously been saved.

Emulator configurations consist of hardware, memory map, and monitor settings.



Setting the Real-Time Options

This section shows you how:

- To allow or deny monitor intrusion
- To turn polling ON or OFF

The monitor program is executed by the emulation microprocessor when target system memory, memory-mapped I/O, and microprocessor registers are displayed or edited. Also, periodic polling to update the Memory, I/O, WatchPoint, and Register windows can cause monitor program execution.

This means that when the user program is running and monitor intrusion is allowed, the user program must be temporarily interrupted in order to display or edit target system memory, display or edit registers, or update window contents.

If it's important that your program execute without these kinds of interruptions, you should deny monitor intrusion. You can still display and edit target system memory and microprocessor registers, but you must specifically break emulator execution from the user program into the monitor first.

When monitor intrusion is denied, polling to update window contents is automatically turned OFF.

When monitor intrusion is allowed, you can turn polling for particular windows OFF to lessen the number of interruptions during user program execution.

To allow or deny monitor intrusion

- To deny monitor intrusion, choose the RealTime→Monitor Intrusion→Disallowed (ALT, R, T, D) command.
- To allow monitor intrusion, choose the RealTime→Monitor Intrusion→Allowed (ALT, R, T, A) command.

When you deny monitor intrusion, any debugger command that may interrupt a running user program is prevented. This ensures the user program execute in real-time.

When you allow monitor intrusion, debugger commands that may temporarily interrupt user program execution are allowed.

The current setting is shown by a check mark (✓) next to the command.



To turn polling ON or OFF

- To turn I/O window polling ON or OFF, choose the RealTime→I/O Polling→ON (ALT, R, I, O) or RealTime→I/O Polling→OFF (ALT, R, I, F) command.
- To turn WatchPoint window polling ON or OFF, choose the RealTime→Watchpoint Polling→ON (ALT, R, W, O) or RealTime→Watchpoint Polling→OFF (ALT, R, W, F) command.
- To turn Memory window polling ON or OFF, choose the RealTime→Memory Polling→ON (ALT, R, M, O) or RealTime→Memory Polling→OFF (ALT, R, M, F) command.

When the user program is running and monitor intrusion is denied, polling is automatically turned OFF.

When the user program is running and monitor intrusion is allowed, you can turn polling OFF to reduce the number of user program interrupts made in order to update I/O, WatchPoint, and Memory window contents.

The current settings are shown by check marks (√) next to the command.

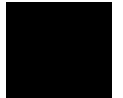

Plugging the Emulator into Target Systems

Plugging the Emulator into Target Systems

This chapter contains information about plugging the emulator into target systems and configuring the emulator so that it operates correctly.

- Connecting the Emulator Probe
- Configuring the Emulator for In-Circuit Operation

For additional help when connecting the emulator to a target system, refer to the Installation/Service/Terminal Interface User's Guide for Motorola 6830x-Family Emulator/Analyzer, HP 64798.

Connecting the Emulator Probe

This section shows you how:

- To plug-in the emulator probe

To plug in the emulator probe

To prevent emulator and probe components from being damaged by static electricity, store and use the emulator in a place resistant to static electricity.

- 1** Turn OFF power to the target system.
- 2** Turn OFF power to the emulator.
- 3** Remove the processor from the target system.
- 4** Connect the probe to the target system as shown in the HP 64798 Installation/Service/Terminal Interface User's Guide for the Motorola 6830x-Family Emulator/Analyzer.
- 5** Turn ON power to the emulator.
- 6** Turn ON power to the target system.

Turning ON power to the emulator before turning ON power to the target system will prevent damage to sensitive components in the target system.
- 7** Start the debugger.

Configuring the Emulator for In-Circuit Operation

Many users of the 6830x emulator encounter problems when first plugging the emulator into their target system. This section should help you avoid or quickly correct most of those problems.

- Step 1. Understand the important concepts
- Step 2. Set up your chip selects
- Step 3. Reprogram chip-select base addresses
- Step 4. Know your interrupt mode
- Step 5. Set up the DTACK signals
- Step 6. If emulator status shows HALTED
- Step 7. Choose the correct target memory access size
- Step 8. Check your DTACK pullup resistor!
- If you have problems

Step 1. Understand the important concepts

There are a few basic concepts related to 6830x emulation that should be understood before you begin. Understanding these concepts will help you avoid common startup problems.

Accessing Memory that is Enabled by a Chip-Select

Nearly all 6830x target systems rely on the built-in chip-selects for at least some accesses to memory. The important concept to remember is that the 6830x emulator does not automatically set up any chip-selects for you other than chip-select zero, which is automatically set up by the 6830x itself.

If you attempt to access memory that is dependent on a chip-select being programmed, without first ensuring that that chip-select is programmed,

some type of failure will result. This most often causes problems when you are trying to do commands such as load memory, display memory, run, or step.

Setting the Interrupt Mode to Dedicated or Normal

The 6830x has two basic types of external interrupts: Normal mode and Dedicated mode. In Normal mode, three lines are used to indicate interrupt levels 0 through 7, or no interrupt. This normal mode scheme is just like the one used on traditional 680X0 devices. In Dedicated mode, the three lines each have a dedicated purpose, one for each of the interrupts level 1, 6, and 7.

Why is this important? The emulator uses a level 7 interrupt to accomplish what is known as a "break" from the user program to the emulation monitor program. The monitor is needed for tasks such as display/modify of target memory and 6830x registers, as well as single-stepping. In order to initiate a level 7 interrupt, the emulator must know what interrupt mode the 6830x has been programmed for. An emulator configuration option is used to indicate which mode the 6830x will be in. If the 6830x is not in that mode when a break is attempted, the break will either fail or lead to unexpected interrupts.

Note that although the 6830x emulator uses the level 7 interrupt, you are free to use the level 7 interrupt for your own purposes. This is because the emulator is able to differentiate between a target system-generated interrupt and an emulator-generated interrupt.

The Freeze Pin and the Monitor

The 6830x has a hardware input pin called FRZ which can be used to "freeze" selected on-chip peripherals. The default emulator configuration asserts the FRZ pin whenever the emulator is running in the monitor. In this state, the watchdog timer will not be serviced. However, knowing that the FRZ pin is asserted during monitor operation allows you to freeze the watchdog timer during this time.

If you wish to allow the watchdog timer to run during execution of the monitor, choose Settings→Emulator Config→Hardware... (ALT, S, E, H) and deselect the Enable Background Freeze check box in the Hardware Config dialog box. With this selection, all processor peripherals will run, a coprocessor will run (if in use), and interrupts will be serviced while the emulator is executing in the monitor.

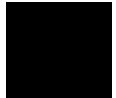

On-Chip Locations

Most of the special features of the 6830x are controlled via a 4-Kbyte block of on-chip locations (RAM and special registers). The address of that 4-Kbyte block is determined by the value written to the BAR. When you configure the emulator, you must map that 4-Kbyte block of memory as target RAM. Mapping that block as "guarded" or "emulation" memory will prevent proper operation or result in guarded memory access errors.

Any display or modify of on-chip locations, including registers, requires the emulation monitor program. If you do a display or modify of these locations or registers while running your program, the emulator will briefly break into the monitor, perform the display or modify, then return to your program.

Step 2. Set up your chip selects

Failure to set up the chip-select registers is by far the most common cause of problems when using the 6830x emulator. If you remember that load, modify/display, step and run commands often rely on valid chip-select settings, you can avoid most of the common mistakes made by users.

The 6830x has four chip-selects, only one of which is enabled after a reset condition. Nearly all 6830x target systems rely on at least one chip-select for accesses to memory. If you are going to access any target memory that relies on a chip-select, then you **MUST** be sure that the appropriate chip-select registers are initialized first. In some cases, even executing code from emulation memory will require that you first initialize your chip selects. This can be done in one of two ways:

Method 1: Using a Command File to Set Up Chip Selects

Use a series of commands or a command file that modifies the registers to the values you will need. For example, here is a command file that sets up CS0 and CS1.

```
RESET  
BREAK  
REG bar TO 800h  
REG or0 TO 3fc2h  
REG br0 TO 0001h
```

```
REG or1 TO 1f80h  
REG br1 TO 0801h
```

Note

It is important that you first modify the BAR register BEFORE you attempt to modify the chip-select registers because the location of those registers is calculated based on the value in the BAR.

The above example will map the Internal system registers to location 800XXXH, and then initialize CS0 as a read-only, 1 wait-state block from 0 through 01FFFFH and CS1 as a read-write, 0 wait-state block from 400000H through 43FFFFH.

If you are going to load your initialization code into target RAM using the emulator, you must use Method 1.

Method 2: Using Your Initialization Code to Set Up Chip Selects

Execute a small section of your initialization code that sets up the proper values in the chip-select registers, and break into the monitor immediately after that, using either a software or analysis breakpoint.

For example, assuming you have the area from 0 through 01FFFFH mapped as emulation ROM and have already written your code to initialize the chip-select registers, you should load that code, set a breakpoint, and then run from a reset condition. When the breakpoint is hit, the chip-selects will have been properly initialized. Here is an example program that will demonstrate this:

```
XDEF      CS_INIT  
ORG      $0  
DC.L     $440000      ; Stack begins at $43FFFE  
DC.L     $400        ; Reset initialization code  
  
ORG      $400  
MOVE.W  #$0800,$F2    ; Set up the BAR for $800XXX  
MOVEA.L #$800000,A0  
MOVE.W  #$3F02,($832,A0) ; OR0 - 512K, read-only, 1 wait-state  
MOVE.W  #$0001,($830,A0) ; BR0 - base address 0  
MOVE.W  #$1F80,($836,A0) ; OR1 - 256K, read-write, 0 wait-state  
MOVE.W  #$0801,($834,A0) ; BR1 - base address $400000  
NOP  
CS_INIT  NOP  
NOP
```

Assuming you have loaded the above example into emulation memory, you can now set a breakpoint on CS_INIT and run from reset.

If your initialization code is loaded in target ROM, you will not be able to set a software breakpoint there. In this case, you should use an analysis breakpoint by tracing about CS_INIT, selecting the break on trigger option, and running from reset.

Note

When using the trace command with the "break on trigger" option, be sure to select an address that is at least two words after the instruction you expect to be executed. This ensures that the analyzer does not break on a "prefetch" of that instruction.

When the emulator breaks into the monitor, the chip-select registers will have been initialized to the values you're using. You can now use display, modify, load, step, or run commands because the chip-selects are properly initialized.

Step 3. Reprogram chip-select base addresses

If you are not going to be changing the base address of chip-select 0 from address 0, or changing the base address registers of the other chip-selects after initial setup, you should skip this step. Dealing with chip-selects whose base addresses are being changed is probably the most difficult challenge you will face with the 6830x emulator.

Before you can successfully emulate in this mode, it is important that you understand how the 6830x uses chip-selects. When you enter memory map terms in your configuration, you will notice that you enter all address ranges without the option to qualify a specific range with a chip-select number. What this means is that the emulation memory mapper cannot "track" changes made to the base address of any chip-selects. Any emulation memory ranges you map respond based on the value on the address bus (and optionally the function code). The chip-select signals are not used by the emulator to decode memory map terms.

What does this mean? This means if you are going to be mapping a block of memory to either emulation RAM or emulation ROM and are going to be changing the base address of that block, you must ensure that valid code or data exists at BOTH blocks of memory. For example, if you have boot code

Chapter 4: Plugging the Emulator into Target Systems Configuring the Emulator for In-Circuit Operation

that originally exists at address 0 and chip-select 0 is later reprogrammed with a base address of 400000H, you must ensure that the code exists at both 0 and at 400000H. If you are executing your code from target memory, this is easy, since your target hardware will be designed to decode memory based on chip-select 0 being active, not based on the full address (A23-A1).

Here is an example of how you can emulate a setup where the chip-select base addresses are being changed. The technique of switching the RAM and ROM addresses closely follows an example that Motorola provides in Revision 2 of the MC68302 User's Manual.

We start with the following memory map:

```
000000..00FFFF@x eram
400000..41FFFF@x eram
800000..800FFF@x tram
```

and use the following program:

```
XDEF      SWITCHED
ORG       $400000
DC.L     $10000           ; Stack begins at $0FFFE
DC.L     RESET-$400000   ; Reset initialization code
DC.L     BUS_ERROR
DC.L     ADDR_ERROR

          ORG            $400400
RESET    MOVE.W         #$0800,$F2           ; Set up the BAR for $800XXX
          MOVEA.L       #$800000,A0
          MOVE.W         #$3FC2,($832,A0)   ; OR0 - 128K, read-only, 1 wait-state
          MOVE.W         #$0001,($830,A0)   ; BR0 - base address 0
          MOVE.W         #$1FE0,($836,A0)   ; OR1 - 64K, read-write, 0 wait-state
          MOVE.W         #$0801,($834,A0)   ; BR1 - base address $400000
          NOP
CP_VECTORS MOVEA.L      #0,A3                ; pointer to vector table
          MOVEA.L       #$400000,A4        ; where to copy it
DO_COPY  MOVE.L         (A3)+,(A4)+
          CMPA.L        #$400,A3           ; at the end?
          BNE          DO_COPY
          NOP                    ; now the vector table is in ROM and RAM
          NOP
CS_INIT  NOP

; the following instructions move code into on-chip RAM, then jump to it.
; A2 is used to point to where ROM WILL be.

          MOVEA.L       #SWITCHED,A2
          MOVEA.L       A0,A1
          MOVE.L        #$317CA001,(A1)+
          MOVE.L        #$0834317C,(A1)+
          MOVE.L        #$C8010830,(A1)+
          MOVE.W        #$4ED2,(A1)+
          JMP           (A0)
          NOP
SWITCHED NOP                    ; it's switched now!!!!!!
```

Chapter 4: Plugging the Emulator into Target Systems

Configuring the Emulator for In-Circuit Operation

```
      NOP
      MOVE.L    0,D0          ; read vector 0
      NOP

BUS_ERROR JMP     BUS_ERROR
ADDR_ERROR JMP    ADDR_ERROR
```

What happens first? The first thing that needs to be done is for you to copy your startup code that will exist in ROM beginning at 400400H to address 400H because what will eventually be address 400400H is address 400H immediately following a reset (because chip-select 0 maps to address 0). To do this, choose the Utilities→Copy... (ALT, -, U, C) command from the Memory window's control menu, enter 400000h as the start address, enter 401fffh as the end address, and enter 0 as the destination address.

This will cause the first 8 Kbytes of code that was loaded at 400000H to be copied to emulation RAM beginning at 0. Doing this will make the emulator act like your target system will at reset. Now you can simply set a breakpoint on SWITCHED and run from reset.

When the emulator breaks into the monitor, chip-select 0 will have been programmed for address range 400000H through 41FFFFFH, and chip-select 1 will have been programmed for address range 0 through 0FFFFFH. Your program can now modify RAM at address 0.

Note that an important limitation of this method is that if a target system reset occurs while your program is running, the program will fail. This is because after a reset, chip-select 0 will again map to address 0, but your code is no longer at address 0. In order to put your code at 0, you would again need to choose the Utilities→Copy... (ALT, -, U, C) command from the Memory window's control menu, enter 400000h as the start address, enter 401fffh as the end address, and enter 0 as the destination address.

There are other ways that you can debug a system that reprograms the base addresses of chip-selects. Another approach would be to debug your system in two separate steps. First, you can debug your initialization code. Once your initialization code is debugged, you can configure the emulator and map memory based on what your final chip-select addresses will be. You can then use a command file to set the chip-selects to their final addresses. This may require some vector table changes.

Still another approach is to use only target memory in areas where chip-selects are used. This doesn't require any special steps since your target memory will "track" the chip-select changes.

Step 4. Know your interrupt mode

If your target does not use dedicated mode interrupts, you can skip this step.

One of the more common problems users encounter is not being able to break into the monitor (ERROR: break failed). A common cause of this is selecting the dedicated interrupt mode in the emulator hardware configuration, but failing to ensure that the 6830x is programmed for dedicated mode interrupts.

The emulator is configured to use normal mode interrupts by default. If you will be setting up the 6830x for dedicated mode interrupts, choose the Settings→Emulator Config→Hardware... (ALT, S, E, H) command and select the dedicated Interrupt Mode option.

The interrupt mode of the 6830x is determined by the value programmed in the GIMR register. If you are using dedicated mode interrupts, you must set the most significant bit of the GIMR register BEFORE you attempt to step or break. Similar to setting up chip-selects, you have two options for making sure you have a valid interrupt mode:

Method 1: Using a Command File to Set the Interrupt Mode

Use a series of commands or a command file that modifies the GIMR to force the 6830x to be in dedicated mode. For example, here is a command file that sets up the GIMR for dedicated mode:

```
RESET  
BREAK  
REG bar TO 800h  
REG gimr TO 8700h
```

Note

It is important that you first modify the BAR register BEFORE attempting to modify the GIMR register because the location of that register is calculated based on the value in the BAR.

Note that doing a break when the 6830x is in a reset state does not require a level 7 interrupt, and therefore will work regardless of the interrupt mode setting.

Method 2: Using Your Initialization Code to Set the Interrupt Mode

Execute a small section of initialization code that sets the GIMR register to the proper value, and break into the monitor immediately after that using either a software or analysis breakpoint.

Here is an example that shows how this works using an analysis breakpoint. In this case, an analysis breakpoint is useful because it will confirm that everything is working properly (if you use a software breakpoint the emulator does not issue a level 7 interrupt, so that would not test the interrupt mode):

Start with the following program loaded in either emulation or target memory:

```
XDEF      CS_INIT,GIMR_INIT
ORG       $0
DC.L     $440000          ; Stack begins at $43FFFE
DC.L     $400            ; Reset initialization code

ORG       $400
MOVE.W   #$0800,$F2      ; Set up the BAR for $800XXX
MOVEA.L  #$800000,A0
MOVE.W   #$3F02,($832,A0) ; OR0 - 512K, read-only, 1 wait-state
MOVE.W   #$0001,($830,A0) ; BR0 - base address 0
MOVE.W   #$1F80,($836,A0) ; OR1 - 256K, read-write, 0 wait-state
MOVE.W   #$0801,($834,A0) ; BR1 - base address $400000
CS_INIT  NOP
          NOP
          NOP
          MOVE.W   #$8740,($812,A0) ; set for dedicated mode interrupt
          NOP
          NOP
GIMR_INIT NOP
          NOP
          NOP
          NOP
```

Assuming you have loaded the above example into emulation or target memory, you can now trace about GIMR_INIT, selecting the break on trigger option, and run from reset.

When the emulator breaks into the monitor, the 6830x will be in dedicated mode. You can now use the step and break command.

Note that if you are just starting to debug your initialization code, and would like to step through each of your startup instructions, you should use Method 1.

Step 5. Set up the DTACK signals

Probably the least understood configuration options relate to the interlocking and source for the DTACK signal. Selecting the options correctly is easy once you know a little bit about your target system.

Selecting the DTACK sources for chip-selects CS0 through CS3 is easy. If you will be programming a chip-select to generate DTACK internally (as is most often the case) you should select "internal"; otherwise, select "external". You may notice that the default for CS0 is "internal" and all others "external". This is because the 6830x CS0 is configured to generate an internal DTACK by default.

If you select the "Map interlock for Emulation memory" entry (default) in the DTACK Control box of the Hardware Config dialog box, the emulator will refer to the memory map and the DTACK specifications defined there for each address range. In the memory map, you can select or deselect "Interlock DTACKs" for each mapped address range. If "Interlock DTACKs" is selected, the emulator is forced to wait for your target system to assert the DTACK signal whenever an access occurs to emulation memory (AND there is no internally generated DTACK for this cycle).

The "Target DTACK always" option in the DTACK Control box of the Hardware Config dialog box is not selected by default and can most often be left that way. When do you need to select it? If ALL of the following are true:

- Your target system asserts DTACK for all areas of memory you will use.
AND
- Your target system inserts at least one wait state for each area.
AND
- You are going to map all areas as emulation RAM or emulation ROM.

What does this do? Using target system DTACKs simply ensures that the emulation memory accesses will have the same number of wait states as your final target system has.

What will happen if ALL of the above are true and you choose to use emulator-generated DTACKs instead of target system DTACKs? In the best case scenario, your code will run faster in the emulator than it will in your target system. This is because an area mapped as emulation memory will

always terminate with the number of wait states selected for the emulator, even if it overlays an address where your target system inserts wait states.

In the worst case scenario, where you should, but do not depend on target system DTACKs, reads or writes to your target memory will fail. This can happen if your target system DTACK circuitry gets confused when the emulator fails to "wait" for your target system to assert DTACK.

If you select Emul. DTACK always, 0 (or 1) wait states, the emulator will ignore the DTACK specifications in the memory map and use the DTACK signal from the emulator for all activity. Choose 0 wait states for fastest system performance. Choose 1 wait state to slow the system if you are having trouble with target system startup.

Step 6. If emulator status shows HALTED

Most users will encounter an emulator status of HALTED at one time or another. This almost always is caused by a double-bus fault, although under rare conditions, it can be caused by the target asserting the "HALT" pin. Note that the 6830x emulator NEVER asserts the HALT pin itself.

A double-bus fault occurs if the 6830x encounters an exception while processing another exception. For example, if a bus error occurs and the 6830x begins to process that bus error, then fetches an odd-address from the vector table location 08H, a double-bus fault will occur.

Most users will encounter a halted condition at least once. You can avoid this problem by making sure you have a "good" stack (that includes making sure that any needed chip-selects are programmed BEFORE any stack accesses occur) and making sure that your bus error and address error exception vector table entries (at 08H and 0CH) point to valid addresses.

If you are encountering a HALTED emulator status, you should initiate an analyzer trace before you run or step. Choose the Trace→Until Halt (ALT, T, U) command. This trace command means "trace all cycles, but NEVER trigger" and is useful because when the processor halts, the analyzer will have the last X states (based on which type analyzer card and mode you are using) in its buffer. By halting the trace with the Trace→Halt (ALT, T, H) command, you will be able to unload the trace buffer and see exactly what caused the double-bus fault.

Chapter 4: Plugging the Emulator into Target Systems Configuring the Emulator for In-Circuit Operation

The 6830x will halt itself if a double-bus fault occurs. Only a target system reset, or emulator reset command will clear the HALTED emulator status.

Here is an example where a Trace→Until Halt (ALT, T, U) command was used to find the cause of a double-bus fault:

```

XDEF      CS_INIT,GIMR_INIT
ORG       $0
DC.L     $440000          ; Stack begins at $43FFFC
DC.L     $400             ; Reset initialization code

ORG       $400
MOVE.W   #$0800,$F2      ; Set up the BAR for $800XXX
MOVEA.L  #$800000,A0
MOVE.W   #03F02,($832,A0) ; OR0 - 512K, read-only, 1 wait-state
MOVE.W   #0001,($830,A0) ; BR0 - base address 0
MOVE.W   #0001,-(A7)     ; push parameter
JSR      CHKSUM          ; jump to checksum subroutine
MOVE.W   #01F80,($836,A0) ; OR1 - 256K, read-write, 0 wait-state
MOVE.W   #0801,($834,A0) ; BR1 - base address $400000
NOP
CS_INIT  NOP
...

```

The memory map used in this configuration includes:

```

000000..01FFFFFF@x eram
400000..43FFFFFF@x tram

```

After choosing the Trace→Until Halt (ALT, T, U) command followed by the Execution→Run... (ALT, E, R) command, selecting the User Reset option, and choosing OK, the Status window shows the emulator is HALTED. At this point, the Trace→Halt (ALT, T, H) command is chosen to stop the trace and display the results.

Looking at the trace we see:

state	typ	module\#line	:function	source	
-14		00040C	MOVE.W	#03F02,00832(A0)	0.640 nS
-13		00040E	3F02	sprog rd word	0.600 nS
-12		000410	0832	sprog rd word	0.640 nS
-11		000412	MOVE.W	#00001,00830(A0)	0.600 nS
-10		800832	3F02	sdata wr word	IAC 0.280 nS
-9		000414	0001	sprog rd word	0.280 nS
-8		000416	0830	sprog rd word	0.320 nS
-7		000418	MOVE.W	#00001,-(A7)	0.320 nS
-6		800830	0001	sdata wr word	IAC 0.240 nS
-5		00041A	0001	sprog rd word	0.320 nS
-4		00041C	JSR	0000446	0.320 nS
-3		00041E	0446	sprog rd word	0.320 nS
-2		43FFFE	0001	sdata wr word	1.020 mS
-1		43FFFC	041E	sdata wr word	1.020 mS

Chapter 4: Plugging the Emulator into Target Systems

Configuring the Emulator for In-Circuit Operation

What to look for:

- state -7 A push of 0001 onto the stack is initiated. The stack pointer is already set to 44000H. The memory below there is accessed using chip-select 1, but the registers for chip-select 1 have not been initialized yet.
- state -2 The processor does a write of 0001 to location 43FFFEH as a result of the instruction at -7, but because the chip-select that would provide DTACK has not yet been initialized, the cycle is not terminated normally. The 1.02 mS time count indicates an internally generated bus error (BERR).
- state -1 Because of the bus error in the previous cycle, the 6830x will immediately begin to process a bus-error exception. The first thing it will try to do is write the low word of the program counter value to the stack. But again, because the chip-select register has not been initialized, this stack write will also fail with a bus error, hence the double-bus fault!

This trace shows how valuable the time stamp can be, not just in highlighting cycles that are unusually long, but also in showing the effect of reprogramming of OR1. You can see how the program fetch on line -11 took approximately 600 ns, but the program fetch on line -9 took only 280 ns. This is a result of the write to OR1 on line -10 which changed the internal DTACK generation from 6 wait states to 1 state.

Many users capture a trace that shows the processor halting, but fail to take the time to analyze the information in the trace. Examining a trace carefully will often help you find the exact cause of a problem.

Step 7. Choose the correct target memory access size

Whenever the emulator accesses either target memory or an on-chip location, it uses the monitor program to do so. The monitor program will use either a "MOVE.B" or "MOVE.W" instruction for this access. You can control this by selecting either "8 bits" or "16 bits" for the "Target memory access" hardware configuration option.

The default value is "16 bits", and this should be acceptable for most cases. There are cases, however, where a target system design allows only byte accesses to a particular area of memory, and you may wish to select "8 bits". You may also find that you need the access size set to "8 bits" sometimes and "16 bits" at other times.

Step 8. Check your DTACK pullup resistor!

It wouldn't be fair to solve all these 6830x plug-in problems and not give the hardware engineer a chance to help out, so there's one last thing you should check before you begin.

Different from the typical 68000 family device, the DTACK signal on the 6830x is bi-directional and will be driven low by the 6830x on all cycles where DTACK is internally generated. This calls for an open-collector design in almost all cases. Have your hardware engineer check the value of the pull-up resistor used on the DTACK signal and make sure that it is approximately 1K ohms. Any value higher than 1K ohms will likely cause problems.

Lowering the value of the pullup resistor ensures that the DTACK signal rises quickly enough. If the DTACK signal rises too slowly you may see incorrect reads from target memory. Why is this? The emulator does alter the characteristics of the DTACK signal (higher capacitive loading and different drive characteristics) and can prevent the DTACK signal from rising to a logic high before the next cycle starts. If DTACK is still seen as a logic low when the next cycle starts, that cycle may be terminated with 0 wait states.

The diagram below shows how a DTACK signal that does not rise quickly enough can cause problems. On the start of the second cycle, the DTACK signal is still seen as low. Even if this is an address configured for a chip-select that has an internally generated DTACK, the slow rising external DTACK will cause problems because the 6830x will sample the DTACK as an input even on cycles programmed for internal DTACK generation. A cycle that should have been a 1 wait-state cycle terminates without any wait-states and results in bad data being read.

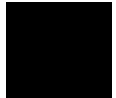

Chapter 4: Plugging the Emulator into Target Systems
Configuring the Emulator for In-Circuit Operation

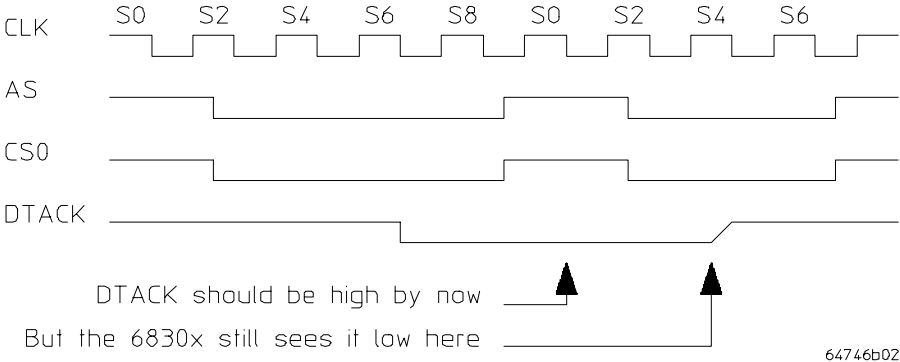

If you have problems

Listed below are common problems and their most common causes.

Problem: You get "ERROR: Stepping failed" when trying to step.

Cause: This is most likely caused by an invalid stack. In order to step, the emulator will first modify the values on the stack, and then execute an RTE. If the stack pointer points to an invalid address, or the chip-select needed to access the stack is not initialized, the stack reads caused by the RTE will result in a double-bus fault.

Fix: Make sure the stack pointer is pointing to a legitimate address and that any chip-selects for that address are initialized.

Problem: You get "ERROR: Break failed" when trying to step.

Cause: You have configured the emulator for dedicated mode interrupts but have not put the 6830x in dedicated mode by modifying the GIMR and setting the most significant bit. Or, the instruction that you single-stepped resulted in a double-bus fault and the processor is now halted.

Fix: Make sure that the processor is set for the correct interrupt mode before single-stepping. If the interrupt mode is correct, then use the trace command before stepping so that you see what went wrong.

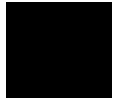

Problem: You get "ERROR: BERR during background access to supervisor stack" when you first try to step or run.

Cause: This problem occurs when the emulator attempts to modify the stack so that your run or step command will begin from the proper address. The emulator will try to modify the stack and then use an RTE to force the program counter and status register to the proper values. In this case, a bus error occurred when the emulator attempted to modify the stack.

Fix: Make sure the stack pointer is pointing to a legitimate address and that any chip-selects for that address are initialized.

Problem: You get "ERROR: Monitor failure; bus error" when trying to do a display, modify, or load command.

Cause: This error means that when the emulator tries to read from, or write to, a memory location mapped as target RAM or ROM, a bus error exception occurred. This can have many causes, but most often is caused when you try to access memory that relies on a chip-select signal, but have not initialized the chip-select registers first.

Fix: Make sure that your chip-select registers are properly initialized.

Problem: Whenever you break into the monitor you have problems with the SCC portion of your program.

Cause: The emulator asserts the FRZ pin when it breaks into the monitor and this in turn "freezes" the Communications Processor. Based on what type of SCC setup you have, and what type of activity is occurring at the time of the break, you may experience unexpected SCC errors or activity. Note that the default emulator configuration selection for the Enable Background Freeze check box in the Hardware Config dialog box causes the FRZ pin to be asserted during the entire time the emulator is running in the monitor. This freezes activity of certain processor peripherals and prevents servicing of interrupts.

Fix: Deselect the Enable Background Freeze check box in the Hardware Config dialog box. This will prevent assertion of the FRZ pin. Or avoid setting any breakpoints while debugging SCC functions. By using the trace analyzer, you can capture a real-time log of SCC-related bus activity. Remember, if you deselect the Enable Background Freeze check box, all processor peripherals will run, a coprocessor will run (if in use), and interrupts will be serviced while the emulator is executing in the monitor.

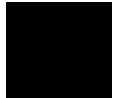

Problem: The emulator status shows HALTED

Cause: A double-bus fault has occurred, or the target system has asserted the HLT pin. This is almost always caused by a double-bus fault. Most often, a bus error or address error exception fails to complete correctly because of an invalid stack or vector table entry.

Fix: Make sure you have a valid stack and valid vector table entries. Refer to "Step 6. If emulator status shows HALTED" for troubleshooting information.

Problem: Incorrect data is read from target RAM or ROM.

Cause: This is most often caused by a slow rising DTACK signal. The DTACK signal is usually pulled high with a resistor. Any resistor value above 1K ohms will usually result in some target memory cycles that are terminated with 0 wait states regardless of how the chip-select registers are programmed.

Fix: Make sure that the pullup resistor on DTACK is no higher than 1K ohms. Refer to "Step 8. Check your DTACK pullup resistor!" for more information.

For additional help when connecting the emulator to a target system, refer to the Installation/Service/Terminal Interface User's Guide for Motorola 6830x-Family Emulator/Analyzer, HP 64798.



Debugging Programs

Debugging Programs

This chapter contains information on loading and debugging programs.

- Loading and Displaying Programs
- Displaying Symbol Information
- Stepping, Running, and Stopping the Program
- Using Breakpoints and Break Macros
- Displaying and Editing Variables
- Displaying and Editing Memory
- Displaying and Editing I/O Locations
- Displaying and Editing Registers
- Tracing Program Execution
- Setting Up Custom Trace Specifications

Loading and Displaying Programs

This section shows you how:

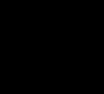
- To load user programs
 - To display source code only
 - To display source code mixed with assembly instructions
 - To display source files by their names
 - To specify source file directories
 - To search for function names in the source files
 - To search for addresses in the source files
 - To search for strings in the source files
- 

To load user programs

- 1** Choose the File→Load Object... (ALT, F, L) command.
- 2** Select the function code of the memory space into which the program should be loaded.
- 3** Select the file to be loaded.
- 4** Choose the Load button to load the program.

Programs are only loaded into the memory ranges mapped with the same *function code*.

With this command, you can load any IEEE-695 object file created with any of the Microtec or HP programming tools for 68000.

To display source code only

- 1 Position the cursor on the starting line to be displayed.
- 2 From the Source window control menu, choose the Display→Source Only (ALT, -, D, S) command.

The Source window may be toggled between the C source only display and the C source/mnemonic mixed display.

The display starts from the line containing the cursor.

The source only display shows line numbers with the source code.

To display source code mixed with assembly instructions

- 1 Position the cursor on the starting line to be displayed.
- 2 From the Source window control menu, choose the Display→Mixed Mode (ALT, -, D, M) command.

The mnemonic display contains the address, data, and disassembled instruction mnemonics intermixed with the C source lines.

Example C Source/Mnemonic Mode Display

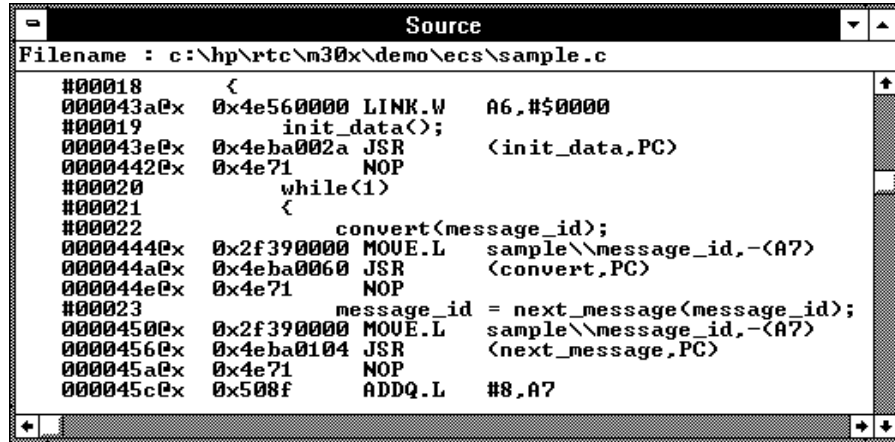

```
Source
Filename : c:\hp\rtc\m30x\demo\ecs\sample.c
#00018      <
000043a0x  0x4e560000 LINK.W   A6, #0000
#00019      init_data();
000043e0x  0x4eba002a JSR    <init_data,PC>
00004420x  0x4e71    NOP
#00020      while(1)
#00021      <
#00022      convert(message_id);
00004440x  0x2f390000 MOVE.L  sample\message_id,-(A7)
000044a0x  0x4eba0060 JSR    <convert,PC>
000044e0x  0x4e71    NOP
#00023      message_id = next_message(message_id);
00004500x  0x2f390000 MOVE.L  sample\message_id,-(A7)
00004560x  0x4eba0104 JSR    <next_message,PC>
000045a0x  0x4e71    NOP
000045c0x  0x508f    ADDQ.L #8,A7
```

To display source files by their names

- 1 Make the Source window the active window, and choose the Display→Select Source... (ALT, -, D, L) command from the Source window's control menu.
- 2 Select the desired file.
- 3 Choose the Select button.
- 4 Choose the Close button.

Note The contents of assembly language source files cannot be displayed.

To specify source file directories

- 1** Make the Source window the active window, and choose the Display→Select Source... (ALT, -, D, L) command from the Source window's control menu.
- 2** Choose the Directory... button.
- 3** Enter the directory name in the Directory text box.
- 4** Choose the Add button.
- 5** Choose the Close button to close the Search Directories dialog box.
- 6** Choose the Close button to close the Select Source dialog box.

If the source files associated with the loaded object file are in different directories from the object file, you must identify the directories in which the source files can be found.

You can also specify them source file directories by setting the SRCPATH environment variable in MS-DOS as follows:

```
set SRCPATH=<full path 1>;<full path 2>
```

To search for function names in the source files

- 1 From the Source window's control menu, choose the Search→Function... (ALT, -, R, F) command.
- 2 Select the function to be searched.
- 3 Choose the Find button.
- 4 Choose the Close button.

Disassembled instructions are displayed in the Source window for assembly language source files.

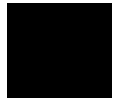

To search for addresses in the source files

- 1 From the Source window's control menu, choose the Search→Address... (ALT, -, R, A) command.
- 2 Type or paste the address into the Address text box.
- 3 Choose the Find button.
- 4 Choose the Close button.

Disassembled instructions are displayed in the Source window for assembly language source files.

To search for strings in the source files

- 1** From the Source window's control menu, choose the Search→String... (ALT, -, R, S) command.
- 2** Type or paste the string into the String text box.
- 3** Select whether the search should be case sensitive.
- 4** Select whether the search should be down (forward) or up (backward).
- 5** Choose the Find Next button. Repeat this step to search for the next occurrence of the string.
- 6** Choose the Cancel button to close the dialog box.

Displaying Symbol Information

This section shows you how:

- To display program module information
- To display function information
- To display external symbol information
- To display local symbol information
- To display global assembler symbol information
- To display local assembler symbol information
- To create a user-defined symbol
- To display user-defined symbol information
- To delete a user-defined symbol
- To display the symbols containing the specified string

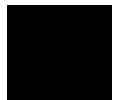

To display program module information

- From the Symbol window's control menu, choose the Display→Modules (ALT, -, D, M) command.

To display function information

- From the Symbol window's control menu, choose the Display→Functions (ALT, -, D, F) command.

The name, type, and address range for the functions in the program are displayed.

Example Function Information Display

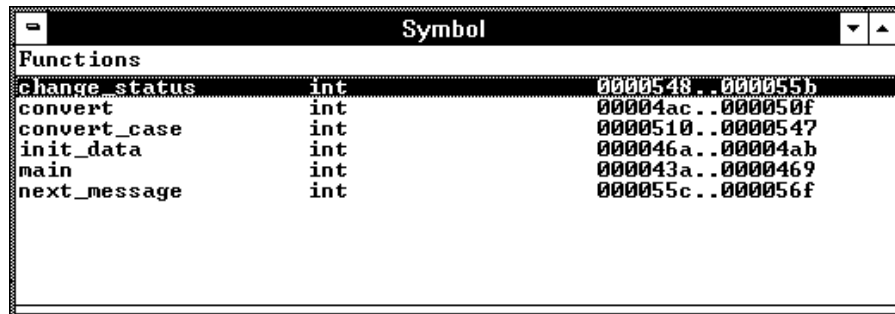

The screenshot shows a window titled "Symbol" with a "Functions" list. The list contains the following entries:

Function Name	Type	Address Range
change_status	int	0000548..000055b
convert	int	00004ac..000050f
convert_case	int	0000510..0000547
init_data	int	000046a..00004ab
main	int	000043a..0000469
next_message	int	000055c..000056f

To display external symbol information

- From the Symbol window's control menu, choose the Display→Externals (ALT, -, D, E) command.

The name, type, and address of the global variables in the program are displayed.

Example

External Symbol Information Display

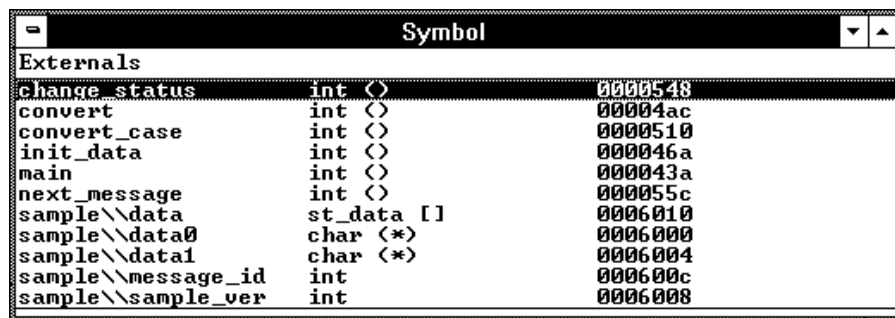

The screenshot shows a window titled "Symbol" with a control menu. The window displays a list of external symbols under the heading "Externals". The symbols are listed with their names, types, and memory addresses.

Symbol Name	Type	Address
change_status	int (<)	0000548
convert	int (<)	00004ac
convert_case	int (<)	0000510
init_data	int (<)	000046a
main	int (<)	000043a
next_message	int (<)	000055c
sample\\data	st_data []	0006010
sample\\data0	char (*)	0006000
sample\\data1	char (*)	0006004
sample\\message_id	int	000600c
sample\\sample_ver	int	0006008

To display local symbol information

- 1 From the Symbol window's control menu, choose the Display→Locals... (ALT, -, D, L) command.
- 2 Type or paste the function for which the local variable information is to be displayed.
- 3 Choose the OK button.

The name, type, and offset from the stack frame of the local variables in the selected function are displayed.

Example

Local Symbol Information Display

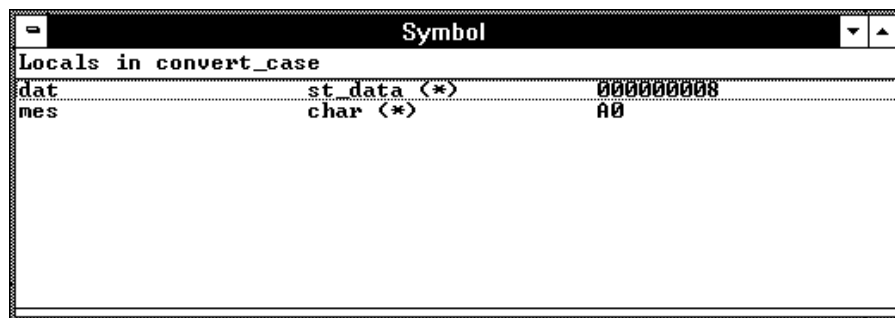

To display global assembler symbol information

- From the Symbol window's control menu, choose the Display→Asm Globals (ALT, -, D, G) command.

The name and address for the global assembler symbols in the program are displayed.

To display local assembler symbol information

- 1 From the Symbol window's control menu, choose the Display→Asm Locals... (ALT, -, D, A) command.
- 2 Type or paste the module for which the local variable information is displayed.
- 3 Choose the OK button.

The name and address for the local assembler variables in the selected module are displayed.

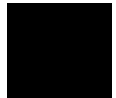

To create a user-defined symbol

- 1 From the Symbol window's control menu, choose the User defined→Add... (ALT, -, U, A) command.
- 2 Type the symbol name in the Symbol Name text box.
- 3 Type the address in the Address text box.
- 4 Choose the OK button.

User-defined symbols, just as standard symbols, can be used as address values when entering commands.

Example

To add the user-defined symbol "jmp_start":

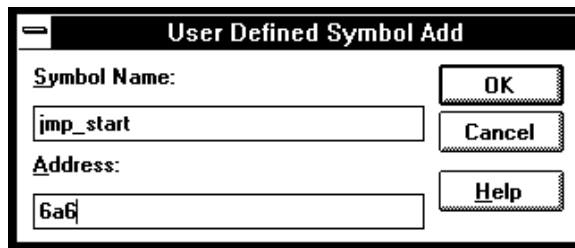

To display user-defined symbol information

- From the Symbol window's control menu, choose the Display→User defined (ALT, -, D, U) command.

The command displays the name and address for the user-defined symbols.

Example

User-Defined Symbol Information Display

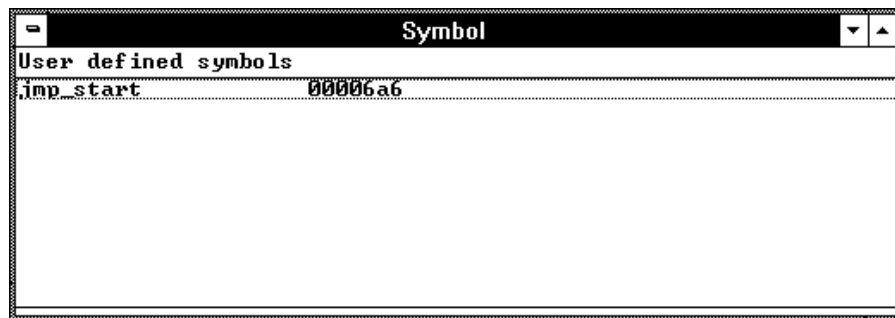

To delete a user-defined symbol

- 1 From the Symbol window's control menu, choose the Display→User defined (ALT, -, D, U) command to display the user-defined symbols.
- 2 Select the user-defined symbol to be deleted.
- 3 From the Symbol window's control menu, choose the User defined→Delete (ALT, -, U, D) command.

To display the symbols containing the specified string

- 1 From the Symbol window's control menu, choose the FindString→String... (ALT, -, F, S) command.
- 2 Type or paste the string in the String text box. The search will be case-sensitive.
- 3 Choose the OK button.

To restore the original non-selective display, redisplay the symbolic information.

Stepping, Running, and Stopping the Program

This section shows you how:

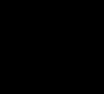
- To step a single line or instruction
 - To step over a function
 - To step multiple lines or instructions
 - To run the program until the specified line
 - To run the program until the current function return
 - To run the program from a specified address
 - To stop program execution
 - To reset the processor
- 

To step a single line or instruction

- Choose the Execution→Single Step (ALT, E, N) command.
- Or, press the F2 key.

In the source display mode, this command executes the C source code line at the current program counter address.

In the source/mnemonic mixed display mode, the command executes the microprocessor instruction at the current program counter address.

Once the source line or instruction has executed, the next program counter address highlighted.

To step over a function

- Choose the Execution→Step Over (ALT, E, O) command.
- Or, press the F3 key.

This command steps a single source line or assembly language instruction except when the source line contains a function call or the assembly instruction makes a subroutine call. In these cases, the entire function or subroutine is executed.

In the source/mnemonic mixed display mode, the command does not distinguish between the following two types of instructions:

JSR

BSR

Example

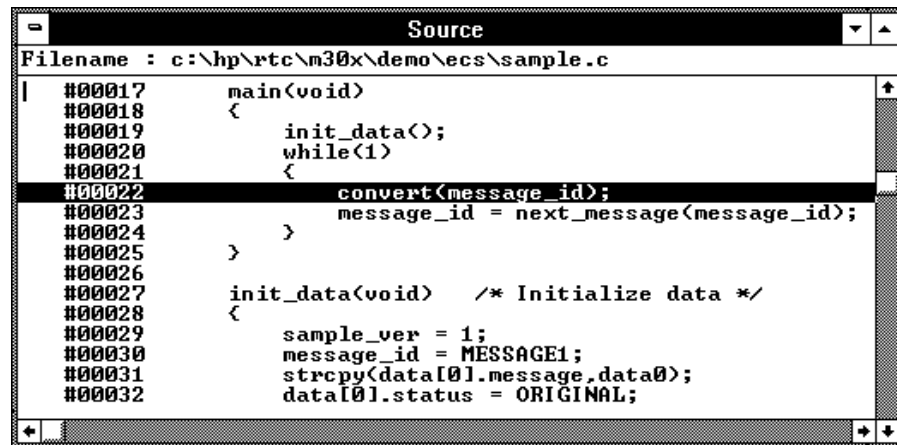

```
Source
Filename : c:\hp\rtc\m30x\demo\ecs\sample.c
| #00017    main(void)
| #00018    {
| #00019        init_data();
| #00020        while(1)
| #00021        {
| #00022            convert(message_id);
| #00023            message_id = next_message(message_id);
| #00024        }
| #00025    }
| #00026
| #00027    init_data(void) /* Initialize data */
| #00028    {
| #00029        sample_ver = 1;
| #00030        message_id = MESSAGE1;
| #00031        strcpy(data[0].message,data0);
| #00032        data[0].status = ORIGINAL;
```

When the current program counter is at line 22, choosing the Execution→Step Over (ALT, E, O) command steps over the "convert" function. Once the function has been stepped over, the program counter indicates line 23.

To step multiple lines or instructions

- 1 Choose the Execution→Step... (ALT, E, S) command.
- 2 Select one of the Current PC, Start Address, or Address options.
(Enter the starting address when the Address option is selected.)
- 3 In the Count text box, type the number of lines to be single-stepped.
- 4 Choose the Execute button.
- 5 Choose the Close button to close the dialog box.

The Current PC option starts single-stepping from the current PC address. The Start Address option starts single-stepping from the *transfer address*. The Address option starts single-stepping from the address specified in the text box.

In the source only display mode, the command steps the number of C source lines specified. In the source/mnemonic mixed display mode, the command steps the number of microprocessor instructions specified.

When the step count specified in the Count text box is 2 or greater, the count decrements by one as each line or instruction executes. A count of 0 remains in the Count text box. Also, in the Source window, the highlighted line that indicates the current program counter moves for each step.

To step over functions, select the Over check box.

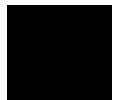

To run the program until the specified line

- 1 Position the cursor in the Source window on the line that you want to run to.
- 2 Choose the Execution→Run to Cursor (ALT, E, C) command.

Execution stops immediately before the cursor-selected line.

Because this command uses breakpoints, you cannot use it when programs are stored in target system ROM.

If the specified address is not reached within the number of milliseconds specified by StepTimerLen in the B3638.INI file, a dialog box appears, asking you to cancel the command by choosing the Stop button. When the Stop button is chosen, the program execution stops, the breakpoint is deleted, and the processor transfers to the RUNNING IN USER PROGRAM status.

Note

This can be done more quickly by using the pop-up menu available with the right mouse button.

To run the program until the current function return

- Choose the Execution→Run to Caller (ALT, E, T) command.

The Execution→Run to Caller (ALT, E, T) command executes the program from the current program counter address up to the return from the current function.

Note

The debugger cannot properly run to the function return when the current program counter is at the first line of the function (immediately after its entry point). Before running to the caller, use the Execution→Single Step (ALT, E, N) command to step past the first line of the function.

To run the program from a specified address

- 1 Choose the Execution→Run... (ALT, E, R) command.
- 2 Select one of the Current PC, Start Address, User Reset, or Address options. (Enter the address when the Address option is selected.)
- 3 Choose the Run button.

The Current PC option executes the program from the current program counter address. The Start Address option executes the program from the *transfer address*.

The User Reset option initiates program execution on receiving a RESET signal from the target system. The reset wait status can be cleared with the Execution→Reset (ALT, E, E) command.

The Address option executes the program from the address specified.

To stop program execution

- Choose the Execution→Break (ALT, E, B) command, or press the F4 key.

As soon as the Execution→Break (ALT, E, B) command is chosen, the emulator starts running in the monitor.

To reset the processor

- Choose the Execution→Reset (ALT, E, E) command.

Once the command has been completed, the processor remains reset if monitor intrusion is disallowed. If monitor intrusion is allowed, the emulation microprocessor may switch immediately from reset to running in monitor, for example, to update the contents of a register window.

Using Breakpoints and Break Macros

This section shows you how:

- To set a breakpoint
- To disable a breakpoint
- To delete a single breakpoint
- To list the breakpoints and break macros
- To set a break macro
- To delete a single break macro
- To delete all breakpoints and break macros

A breakpoint is an address you identify in the user program where program execution is to stop. Breakpoints let you look at the state of the target system at particular points in the program.

A break macro is a breakpoint followed by any number of macro commands (which are the same as command file commands).

Because breakpoints are set by replacing opcodes in the program, you cannot set breakpoints or break macros in programs stored in target system ROM.

All breakpoints are deleted when RTC is exited.

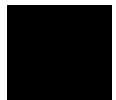

To set a breakpoint

- 1 Position the cursor on the line where you wish to set a breakpoint.
- 2 Choose the Breakpoint→Set at Cursor (ALT, B, S) command.

When you run the program and the breakpoint is hit, execution stops immediately before the breakpoint line. The current program counter location is highlighted.

Example To set a breakpoint at line 56:

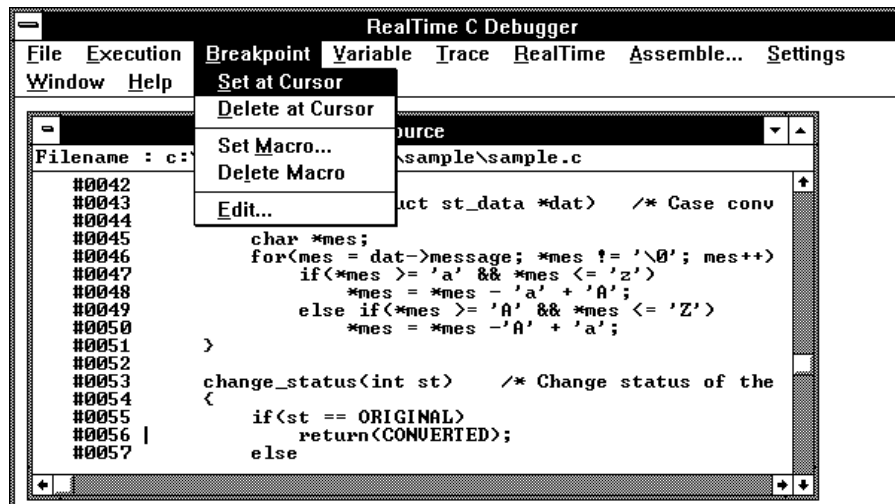

Note This can be done more quickly by using the pop-up menu available with the right mouse button.

To disable a breakpoint

- 1 Choose the Breakpoint→Edit... (ALT, B, E) command.
- 2 Select the breakpoint to be disabled.
- 3 Choose the Enable/Disable button. Notice that "DI" appears next to the breakpoint in the list.
- 4 To close the dialog box, choose the Close button.

You can reenable a breakpoint in the same manner by choosing the Breakpoint→Edit... (ALT, B, E) command, selecting a disabled breakpoint from the list, and choosing the Enable/Disable Button.

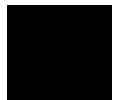

To delete a single breakpoint

- Position the cursor on the line that has the breakpoint to be deleted, and choose the Breakpoint→Delete at Cursor (ALT, B, D) command.

Or:

- 1 Choose the Breakpoint→Edit... (ALT, B, E) command.
- 2 Select the breakpoint to be deleted.
- 3 Choose the Delete button.
- 4 Choose the Close button.

The Breakpoint→Edit... (ALT, B, E) command allows you to delete all the breakpoints and break macros at once with the Delete All button.

To list the breakpoints and break macros

- Choose the Breakpoint→Edit... (ALT, B, E) command.

The command displays breakpoints followed by break macro commands in parentheses.

The Breakpoint Edit dialog box also allows you to delete breakpoints and break macros.

To set a break macro

- 1 Position the cursor on the line where you wish to set a break macro.
- 2 Choose the Breakpoint→Set Macro... (ALT, B, M) command.
- 3 Select the Add Macro check box in the Breakpoint Edit dialog box.
- 4 Specify the macro command in the Macro Command text box.
- 5 Choose the Set button.
- 6 To add another macro command, repeat steps 4 and 5.
- 7 To exit the Breakpoint Edit dialog box, choose the Close button.

The debugger automatically executes the specified macro commands when the *break macro* line is reached.

To add macro commands after an existing macro command, position the cursor on the macro command before choosing Breakpoint→Set Macro... (ALT, B, M).

To add macro commands to the top of an existing break macro, position the cursor on the line that contains the BP marker before choosing Breakpoint→Set Macro... (ALT, B, M).

Example

To set "EVALUATE" and "RUN" break macros:

Position the cursor on line 47; then, choose the Breakpoint→Set Macro... (ALT, B, M) command.

Select the Add Macro check box.

Enter "EVALUATE *mes" in the Macro Command text box.

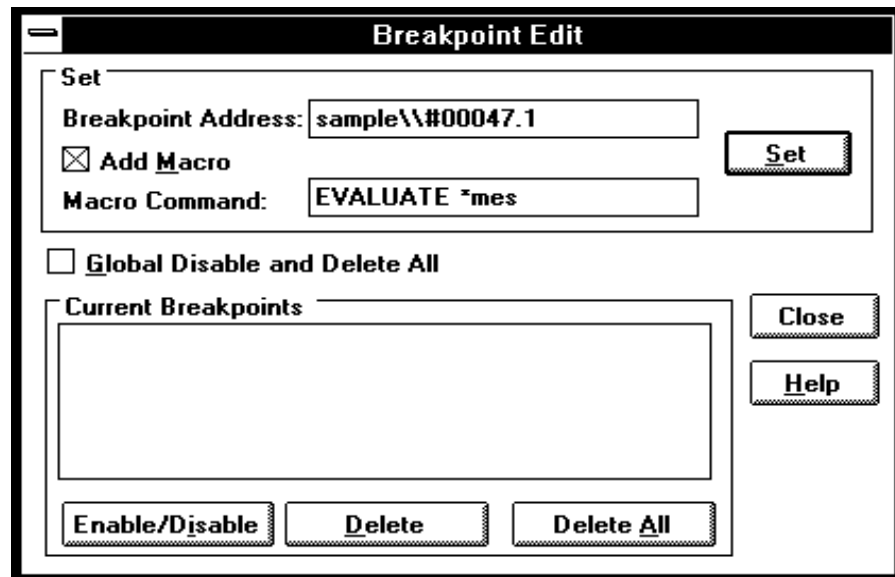

Choose the Set button.

Enter "RUN" in the Macro Command text box.

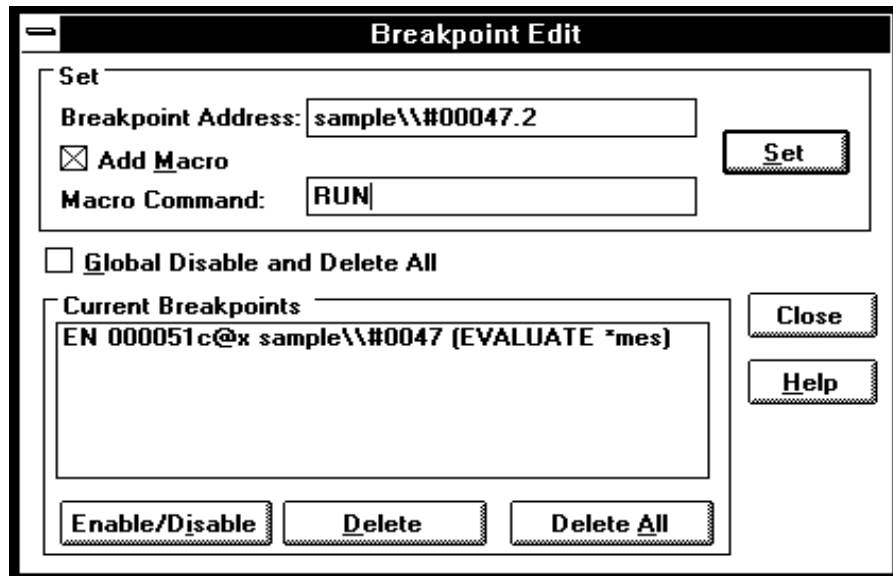

Choose the Set button.

Choose the Close button.

The break macro is displayed in the Source window as shown below.

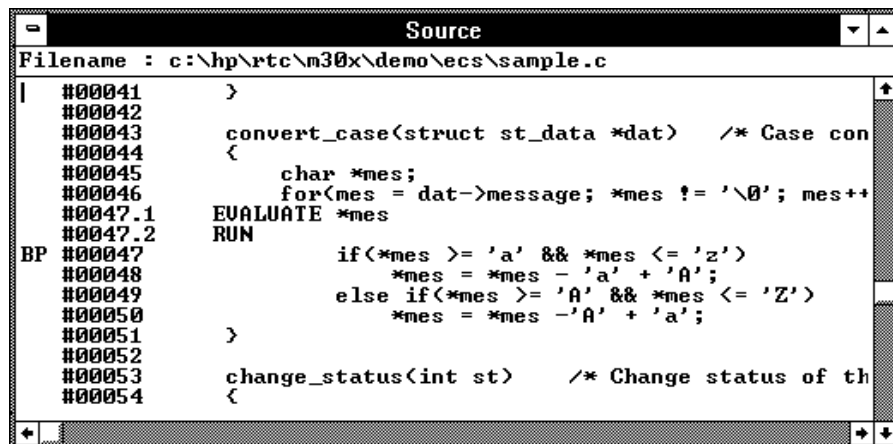

To delete a single break macro

- 1** Position the cursor on the line that contains the break macro to be deleted.
- 2** Choose the Breakpoint→Delete Macro (ALT, B, L) command.

To delete a single macro command that is part of a break macro, position the cursor on the macro command before choosing Breakpoint→Delete Macro (ALT, B, L).

The Breakpoint→Edit... (ALT, B, E) command allows you to delete all the breakpoints and break macros at once by choosing the Delete All button. Also, by selecting the Global Disable and Delete All check box, you can delete all breakpoints and break macros and prevent creation of new breakpoints and break macros.

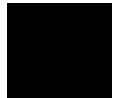

To delete all breakpoints and break macros

- 1 Choose the Breakpoint→Edit... (ALT, B, E) command.
- 2 Choose the Delete All button.
- 3 Select the Global Disable and Delete All check box.
- 4 Choose the Close button.

The Breakpoint→Edit... (ALT, B, E) command allows you to delete all the breakpoints and break macros at once with the Delete All button. Also, you can delete all breakpoints and break macros and prevent creation of new breakpoints and break macros by selecting the Global Disable and Delete All check box.

Displaying and Editing Variables

This section shows you how:

- To display a variable
- To edit a variable
- To monitor a variable in the WatchPoint window

To display a variable

- 1** Position the mouse pointer over the variable in the Source window and double-click the left mouse button.
- 2** Choose the Variable→Edit... (ALT, V, E) command.
- 3** Choose the Update button to read the contents of the variable and display the value in the dialog box.
- 4** To exit the Variable dialog box, choose the Close button.

Note that you can update the contents of an auto variable only while the program executes within the scope function.

To edit a variable

- 1 Position the mouse pointer over the variable in the Source window and double-click the left mouse button.
- 2 Choose the Variable→Edit... (ALT, V, E) command.
- 3 Choose the Modify button. This opens the Variable Modify dialog box.
- 4 Type the desired value in the Value text box. The value must be of the type specified in the Type field.

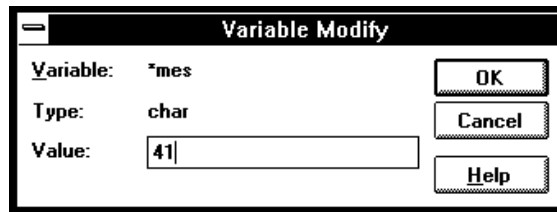

- 5 Choose the OK button.
- 6 Choose the Close button.

Note that you can change the contents of an auto variable only while the program executes within the scope function.

To monitor a variable in the WatchPoint window

- 1 Highlight the variable in the Source window by either double-clicking the left mouse button or by holding the left mouse button down and dragging the mouse pointer over the variable.
- 2 Choose the Variable→Edit... (ALT, V, E) command.
- 3 Choose the "to WP" button.
- 4 Choose the Close button.
- 5 To open the WatchPoint window, choose the Window→WatchPoint command.

Note that you can only monitor an auto variable in the WatchPoint window when the program executes within the scope function.



Displaying and Editing Memory

This section shows you how:

- To display memory
- To edit memory
- To copy memory to a different location
- To copy target system memory into emulation memory
- To modify a range of memory with a value
- To search memory for a value or string

To display memory

- 1** Choose the RealTime→Memory Polling→ON (ALT, R, M, O) command.
- 2** Choose the Window→Memory command.
- 3** Double-click one of the addresses.
- 4** Use the keyboard to enter the address of the memory locations to be displayed.
- 5** Press the Enter key.

An address may be entered as a value or symbol. You can also select the desired address by using the scroll bar.

To change the size of the data displayed, access the Memory window's control menu; then, choose the Display→Byte (ALT, -, D, Y), Display→16 Bits (ALT, -, D, 1), or Display→32 Bits (ALT, -, D, 3) command. When the

Display→Byte (ALT, -, D, Y) command is chosen, ASCII values are also displayed.

To specify whether memory is displayed in a single-column or multicolumn format, access the Memory window's control menu; then, choose the Display→Linear (ALT, -, D, L) or Display→Block (ALT, -, D, B) command. When the Display→Linear (ALT, -, D, L) command is chosen, symbolic information associated with an address is also displayed.

The Memory window display is updated periodically. When the window displays the contents of target system memory, user program execution is temporarily suspended as the display is updated. To prevent program execution from being temporarily suspended (and the Memory window from being updated), choose the RealTime→Monitor Intrusion→Disallowed (ALT, R, T, D) command to activate the real-time mode.

Example Memory Displayed in Byte Format

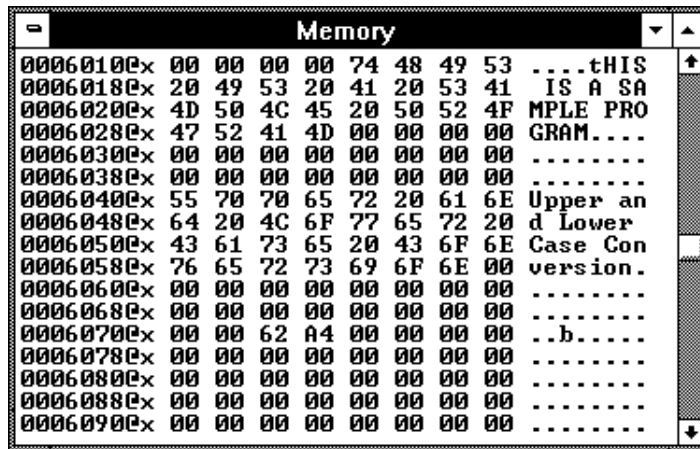

To edit memory

Assuming the location you wish to edit has already been displayed (and Memory window polling is turned ON):

- 1** Double-click the location you wish to edit.
- 2** Use the keyboard to enter a new value.
- 3** Press the Enter key. Notice that the next location is highlighted.
- 4** Repeat steps 2 and 3 to edit successive locations.

Editing the contents of target system memory causes user program execution to be temporarily interrupted. You cannot modify the contents of target memory when the emulator is running the user program and monitor intrusion is disallowed.

To copy memory to a different location

- 1 From the Memory window's control menu, choose the Utilities→Copy... (ALT, -, U, C) command.
- 2 Enter the starting address of the range to be copied in the Start text box.
- 3 Enter the end address of the range to be copied in the End text box.
- 4 Enter the address of the destination in the Destination text box.
- 5 Choose the Execute button.
- 6 To close the Memory Copy dialog box, choose the Close button.

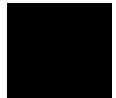

To copy target system memory into emulation memory

- 1 Map the address range to be copied as emulation memory.
- 2 Because the processor cannot read target system memory when it is in the EMULATION RESET state, choose the Execution→Break (ALT, E, B) command, or press the F4 key, to break execution into the monitor.
- 3 From the Memory window's control menu, choose the Utilities→Image... (ALT, -, U, I) command.
- 4 Enter the starting address in the Start text box.
- 5 Enter the end address in the End text box.
- 6 Choose the Execute button.
- 7 To exit the Memory Image Copy dialog box, choose the Close button.

This command is used to gain access to features that are available with emulation memory (like breakpoints).

The following commands cannot be used when programs are stored in target system ROM. However, you can use these commands if you copy the contents of target system ROM into emulation memory with the Utilities→Image... (ALT, -, U, I) command:

- Breakpoint→Set at Cursor (ALT, B, S)
- Breakpoint→Delete at Cursor (ALT, B, D)
- Breakpoint→Set Macro... (ALT, B, M)
- Breakpoint→Delete Macro (ALT, B, L)
- Execution→Run to Cursor (ALT, E, C)
- Execution→Run to Caller (ALT, E, T)
- Settings→Coverage→Coverage ON (ALT, S, V, O)
- Settings→Coverage→Coverage Reset (ALT, S, V, R)

Example

To copy the contents of addresses 0h through ffffh with "X" function code from target system memory to the corresponding emulation memory address range:

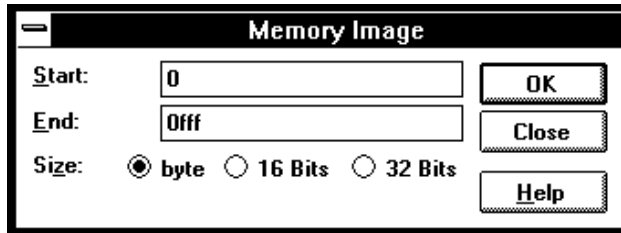

To modify a range of memory with a value

- 1 From the Memory window's control menu, choose the Utilities→Fill... (ALT, -, U, F) command.
- 2 Enter the desired value in the Value text box.
- 3 Enter the starting address of the memory range in the Start text box.
- 4 Enter the end address in the End text box.
- 5 Select one of the Size options.
- 6 Choose the Execute button.

The Byte, 16 Bit, or 32 Bit size option specifies the size of the values that are used to fill memory.

To search memory for a value or string

- 1 From the Memory window's control menu, choose the Search... (ALT, -, R) command.
- 2 Enter in the Value or String text box the value or string to search for.
- 3 Enter the starting address in the Start text box.
- 4 Enter the end address in the End text box.
- 5 Choose the Execute button.
- 6 Choose the Close button.

When the specified data is found, the location at which the value or string was found is displayed in the Memory window.

Example

To search addresses 6000h through 0ffffh, for the string "This":

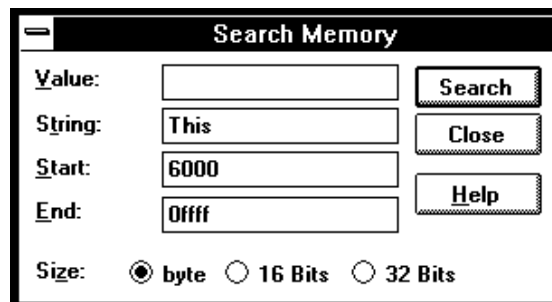

Displaying and Editing I/O Locations

This section shows you how:

- To display I/O locations
- To edit an I/O location

With the 6830x microprocessor, I/O locations are memory-mapped.

To display I/O locations

- 1 Choose the Window→I/O command.
- 2 From the I/O window's control menu, choose the Define... (ALT, -, D) command.
- 3 Enter the address in the Address text box.
- 4 Select whether the size of the I/O location is a Byte or 16 Bits.
- 5 Choose the Set button.
- 6 Choose the Close button.

The Window→I/O command displays the contents of the specified I/O locations.

The debugger periodically reads the I/O locations and displays the latest status in the I/O window. To prevent the debugger from reading the I/O locations (and updating the I/O window), choose the RealTime→I/O Polling→OFF (ALT, R, I, F) command.

Example To display the contents of address 2000:

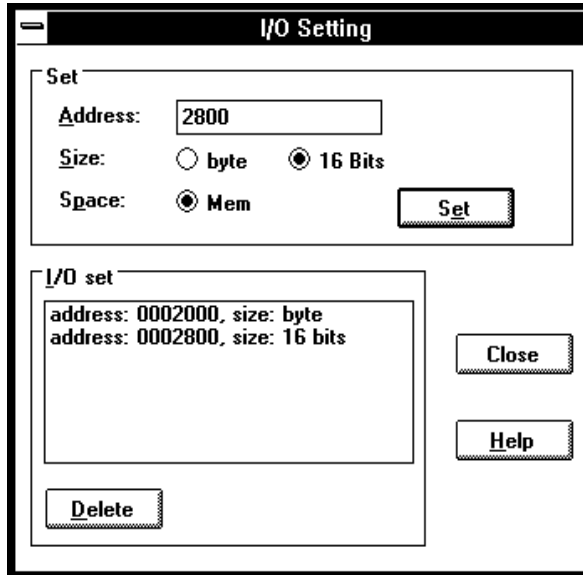

To edit an I/O location

- 1 Display the I/O value to be changed with the Window→I/O command.
- 2 Double-click the value to be changed.
- 3 Use the keyboard to enter a new value.
- 4 Press the Enter key.

To confirm the modified values, press the Enter key for every changed value.

Editing the I/O locations temporarily halts user program execution. You cannot modify I/O locations while the user program executes in the real-time mode or when I/O polling is turned OFF.

Displaying and Editing Registers

This section shows you how:

- To display registers
- To edit registers

To display registers

- Choose the **Window→Basic Registers** command (or name any desired set of registers).

The register values displayed in the window are periodically updated to show you how the values change during program execution. The decoded flag register flags allow you to identify the register status at a glance.

When a register window is updated, user program execution is temporarily interrupted. To prevent the user program from being interrupted (and the register window from being updated), choose the **RealTime→Monitor Intrusion→Disallowed (ALT, R, T, D)** command to activate the real-time mode.



Example Register contents Displayed in the Basic Registers Window

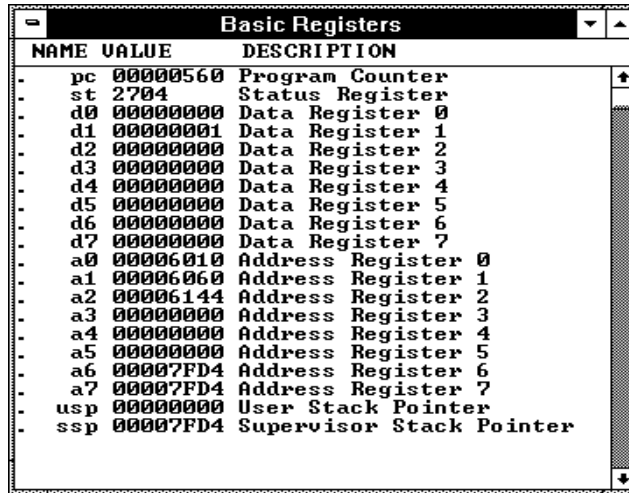

The image shows a window titled "Basic Registers" containing a table with three columns: NAME, VALUE, and DESCRIPTION. The table lists various registers including the Program Counter (pc), Status Register (st), Data Registers (d0-d7), Address Registers (a0-a7), User Stack Pointer (usp), and Supervisor Stack Pointer (ssp).

NAME	VALUE	DESCRIPTION
pc	00000560	Program Counter
st	2704	Status Register
d0	00000000	Data Register 0
d1	00000001	Data Register 1
d2	00000000	Data Register 2
d3	00000000	Data Register 3
d4	00000000	Data Register 4
d5	00000000	Data Register 5
d6	00000000	Data Register 6
d7	00000000	Data Register 7
a0	00006010	Address Register 0
a1	00006060	Address Register 1
a2	00006144	Address Register 2
a3	00000000	Address Register 3
a4	00000000	Address Register 4
a5	00000000	Address Register 5
a6	00007FD4	Address Register 6
a7	00007FD4	Address Register 7
usp	00000000	User Stack Pointer
ssp	00007FD4	Supervisor Stack Pointer

To edit registers

- 1 Display the register contents by choosing the Window→Basic Registers command (or any desired set of registers).
- 2 Double-click the value to be changed.
- 3 Use the keyboard to enter a new value.
- 4 Press the Enter key.

Modifying register contents temporarily interrupts program execution. You cannot modify register contents while the user program is running and monitor intrusion is disallowed.

Note that register values are not actually changed until the Enter key is pressed.

Double-clicking the status register (st) contents opens the Register Bit Fields dialog box which you can use to set or clear individual bit fields.

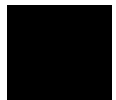

Tracing Program Execution

This section shows you how:

- To trace function flow
- To trace callers of a specified function
- To trace execution within a specified function
- To trace accesses to a specified variable
- To trace before a particular variable value and break
- To trace until the command is halted
- To stop a running trace
- To repeat the last trace
- To identify bus arbitration cycles in the trace
- To display bus cycles
- To display absolute or relative counts

How the Analyzer Works

When you trace program execution, the analyzer captures microprocessor address bus, data bus, and control signal values at each clock cycle. The values captured for one clock cycle are collectively called a state. A trace is a collection of these states stored in analyzer memory (also called trace memory).

The trigger condition tells the analyzer when to store states in trace memory. The trigger position specifies whether states are stored before, after, or about the state that satisfies the trigger condition.

The store condition limits the kinds of states that are stored in trace memory.

When the states stored are limited by the store condition, up to two states which satisfy the prestore condition may be stored when they occur before the states that satisfy the store condition.

After a captured state satisfies the trigger condition, a trace becomes complete when trace memory is filled with states that satisfy the store and prestore conditions.

Note

The analyzer traces unexecuted instructions due to prefetching in 6830x.

Trace Window Contents

When traces are completed, the Trace window is automatically opened to display the trace results.

Each line in the trace shows the trace buffer state number, the type of state, the module name and line number, the function name, the source file information, and the time information for the state (relative to the other lines, by default).

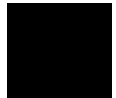

When bus cycles are included, the address, data, and disassembled instruction or bus cycle status mnemonics are shown.

To trace function flow

- Choose the Trace→Function Flow (ALT, T, F) command.

The command stores function entry points, and the resulting trace shows program execution flow.

The command traces C function entry points only. It does not trace execution for assembly language routines.

Note

When using the MCC68K compiler, you must specify the -Kf option when compiling programs in order for the debugger to be able to trace function flow.

Example

Function Flow Trace

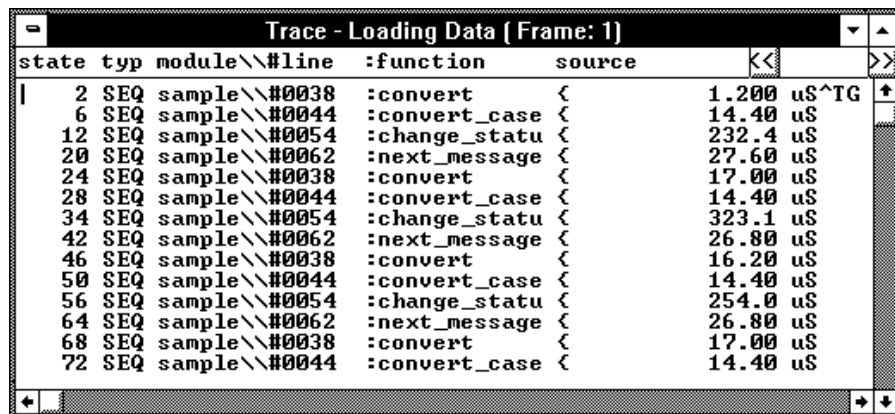

state	typ	module\#line	:function	source		
	2	SEQ sample\#0038	:convert	<	1.200	uS^TG
	6	SEQ sample\#0044	:convert_case	<	14.40	uS
	12	SEQ sample\#0054	:change_statu	<	232.4	uS
	20	SEQ sample\#0062	:next_message	<	27.60	uS
	24	SEQ sample\#0038	:convert	<	17.00	uS
	28	SEQ sample\#0044	:convert_case	<	14.40	uS
	34	SEQ sample\#0054	:change_statu	<	323.1	uS
	42	SEQ sample\#0062	:next_message	<	26.80	uS
	46	SEQ sample\#0038	:convert	<	16.20	uS
	50	SEQ sample\#0044	:convert_case	<	14.40	uS
	56	SEQ sample\#0054	:change_statu	<	254.0	uS
	64	SEQ sample\#0062	:next_message	<	26.80	uS
	68	SEQ sample\#0038	:convert	<	17.00	uS
	72	SEQ sample\#0044	:convert_case	<	14.40	uS

To trace callers of a specified function

- 1 Double-click the function name in one of the debugger windows.
- 2 Choose the Trace→Function Caller... (ALT, T, C) command.
- 3 Choose the OK button.

This command stores the first executable statement of the specified function and prestores statements that execute before it. The prestored statements show the caller of the function.

To identify interrupts in program execution, trace the caller of the interrupt process routine using the Trace→Function Caller... (ALT, T, C) command.

For Assembler symbols, the system traces the last two instructions executed before the specified Assembler symbol is reached. Specifying the first symbol of a subroutine enables the system to trace the caller of the subroutine.

Note

The analyzer may fail in tracing the caller due to prefetching in 6830x. To avoid this failure, specify the function by a value of its address + 2.

Chapter 5: Debugging Programs
Tracing Program Execution

Example To trace the caller of "next_message":
Double-click "next_message".

Choose the Trace→Function Caller... (ALT, T, C) command.

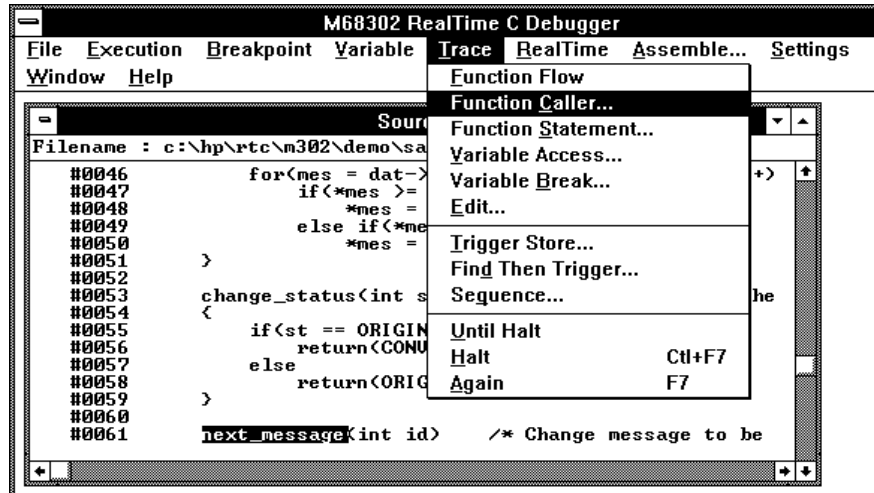

The Trace window becomes active and displays the trace results.

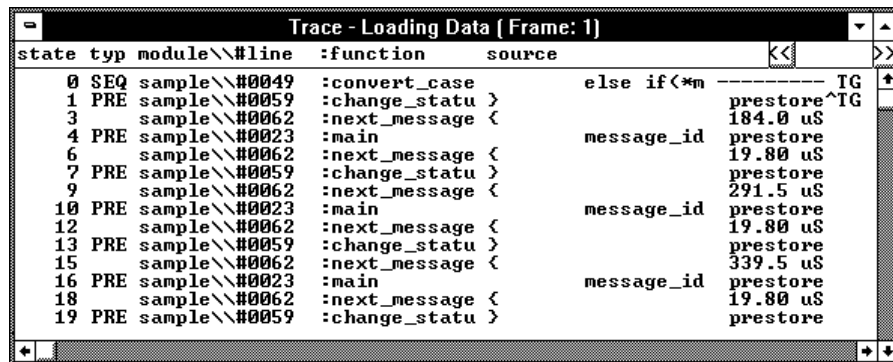

You can see how prefetching affects tracing by choosing the Display→Mixed Mode (ALT, -, D, M) command from the Trace window's control menu.

To trace execution within a specified function

- 1 Double-click the function name in the Source window.
- 2 Choose the Trace→Function Statement... (ALT, T, S) command.

This command traces C functions only. It does not trace execution of assembly language subroutines.

Example

To trace execution within "next_message":

Double-click "next_message".

Choose the Trace→Function Statement... (ALT, T, S) command.

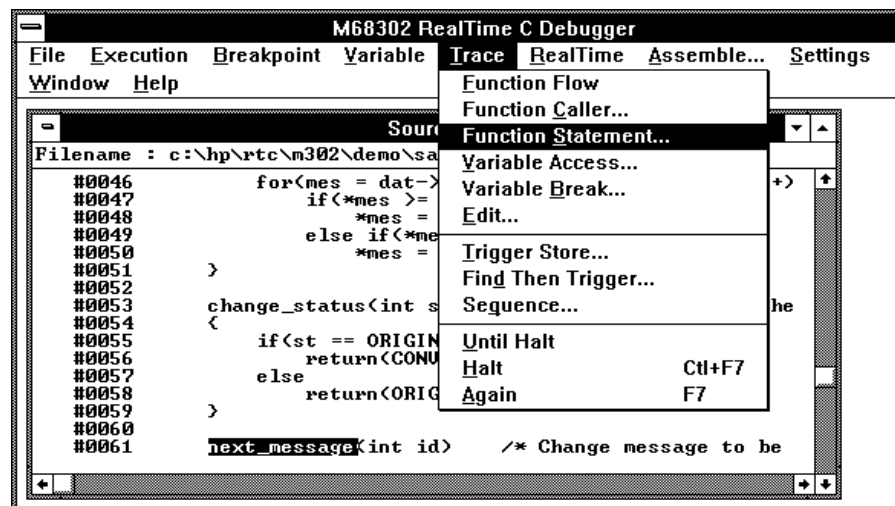

The Trace window becomes active and displays the results. You can see how prefetching affects tracing by choosing the Display→Mixed Mode (ALT, -, D, M) command from the Trace window's control menu.

To trace accesses to a specified variable

- 1 Double-click the global variable name in the Source window.
- 2 Choose the Trace→Variable Access... (ALT, T, V) command.

The command also traces access to the Assembler symbol specified by its name and size.

Example

To trace access to "message_id":

Double-click "message_id".

Choose the Trace→Variable Access... (ALT, T, V) command.

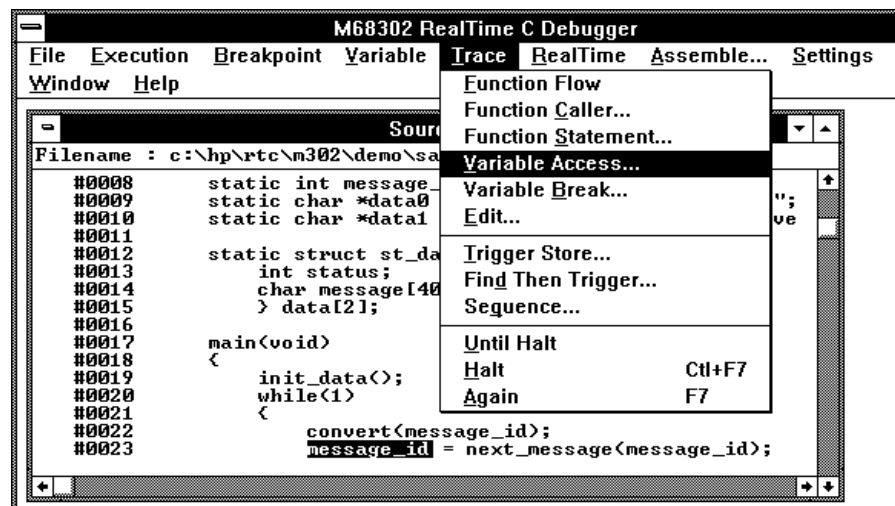

The Trace window becomes active and displays the trace results.

To trace before a particular variable value and break

- 1 Double-click the desired global variable.
- 2 Choose the Trace→Variable Break... (ALT, T, B) command.
- 3 Enter the value in the Value text box.
- 4 Choose the OK button.

The Trace→Variable Break... (ALT, T, B) command breaks execution as soon as the specified value is written to the specified global variable.

The command also breaks execution at the Assembler symbol specified by its name and size.

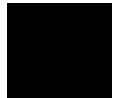

Chapter 5: Debugging Programs
Tracing Program Execution

Example To break execution as soon as "message_id" contains "0":
Double-click "message_id".
Choose the Trace→Variable Break... (ALT, T, B) command.

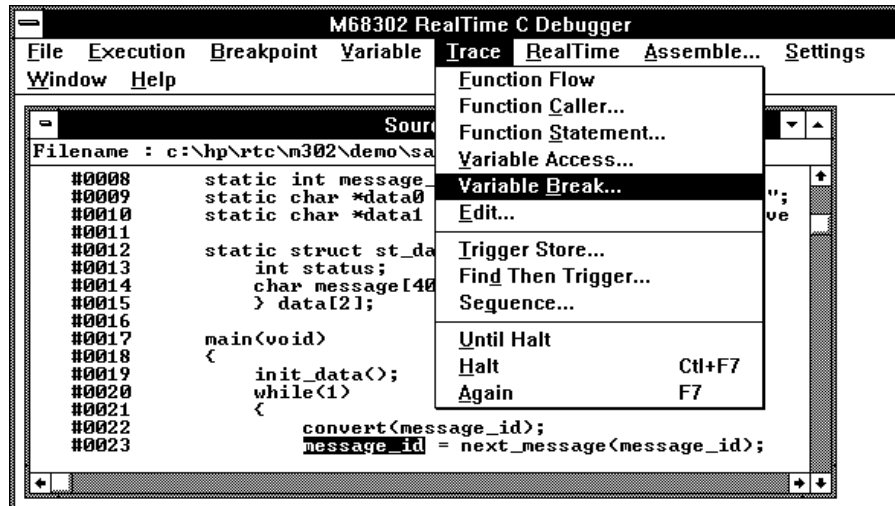

Enter "0" in the Value text box.

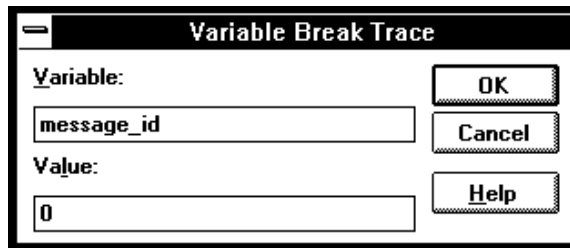

Choose the OK button.

The debugger halts execution as soon as the program writes "0" to the "message_id" variable. Once execution has halted, the Trace window becomes active and displays the results.

To trace until the command is halted

- 1 To start the trace, choose the Trace→Until Halt (ALT, T, U) command.
- 2 When you are ready to stop the trace, choose the Trace→Halt (ALT, T, H) command.

This command is useful, for example, in tracing program execution that leads to a processor halted state or to a break to the monitor.

To stop a running trace

- Choose the Trace→Halt (ALT, T, H) command.

The command is used to:

Stop the trace initiated with the Trace→Until Halt (ALT, T, U) command.

Force termination of the trace that cannot be completed due to absence of the specified state.

Stop a trace before the trace buffer becomes full.

To repeat the last trace

- Choose the Trace→Again (ALT, T, A) command, or press the F7 key.

The Trace→Again (ALT, T, A) command traces program execution using the last trace specification stored in the HP 64700.

To identify bus arbitration cycles in the trace

- 1** Choose the Settings→Emulator Config→Hardware... (ALT, S, E, H) command.
- 2** Select the Tag Bus Arbitration for Analyzer option.
- 3** Choose the OK button to confirm your selection.

When the Tag Bus Arbitration for Analyzer option is selected, a state is stored in trace memory when a bus arbitration cycle occurs.

Bus arbitration tag states can be identified using the dma predefined status value.

To display bus cycles

- 1** Place the cursor on the line from which you wish to display the bus cycles.
- 2** From the Trace window's control menu, choose the Display→Mixed Mode (ALT, -, D, M) command or the Display→Bus Cycle Only (ALT, -, D, C) command.

The Display→Mixed Mode (ALT, -, D, M) command displays each source line followed by the bus cycles associated with it.

The Display→Bus Cycle Only (ALT, -, D, C) command displays the bus cycles without the source lines.

The display starts from the cursor-selected line.

To hide the bus cycles, choose the Display→Source Only (ALT, -, D, S) command from the Trace window's control menu.

Example Bus Cycles Displayed in Trace with "Mixed Mode" selected:

To display absolute or relative counts

- From the Trace window's control menu, choose the Display→Count→Absolute (ALT, -, D, C, A) or Display→Count→Relative (ALT, -, D, C, R) command.

Choosing the Display→Count→Relative (ALT, -, D, C, R) command selects the relative mode where the state-to-state time intervals are displayed.

Choosing the Display→Count→Absolute (ALT, -, D, C, A) command selects the absolute mode where the trace time is displayed as the total time elapsed since the analyzer has been triggered.

Setting Up Custom Trace Specifications

This section shows you how:

- To set up a "Trigger Store" trace specification
- To set up a "Find Then Trigger" trace specification
- To set up a "Sequence" trace specification
- To edit a trace specification
- To trace "windows" of program execution
- To store the current trace specification
- To load a stored trace specification

Note

The analyzer traces unexecuted instructions due to prefetching in 6830x.

Note

Analyzer memory is unloaded two states at a time. If you use a storage qualifier to capture states that do not occur often, it's possible that one of these states has been captured and stored but cannot be displayed because another state must be stored before the pair can be unloaded. When this happens, you can stop the trace measurement to see all stored states.

When Do I Use the Different Types of Trace Specifications?

When you wish to trigger the analyzer on the occurrence of one state, use the "Trigger Store" dialog box to set up the trace specification.

When you wish to trigger the analyzer on the occurrence of one state followed by another state, or one state followed by another state but only when that state occurs before a third state, use the "Find Then Trigger" dialog box to set up the trace specification.

When you wish to trigger the analyzer on a sequence of more than two states, use the "Sequence" dialog box to set up the trace specification.

To set up a "Trigger Store" trace specification

- 1 Choose the Trace→Trigger Store... (ALT, T, T) command.
- 2 Specify the *trigger condition* using the Address, Data, and/or Status text boxes within the Trigger group box.
- 3 Specify the *trigger position* by selecting the trigger start, trigger center, or trigger end option in the Trigger group box.
- 4 Specify the *store condition* using the Address, Data, and/or Status text boxes within the Store group box.
- 5 Choose the OK button to set up the analyzer and start the trace.

The Trace→Trigger Store... (ALT, T, T) command opens the Trigger Store Trace dialog box:

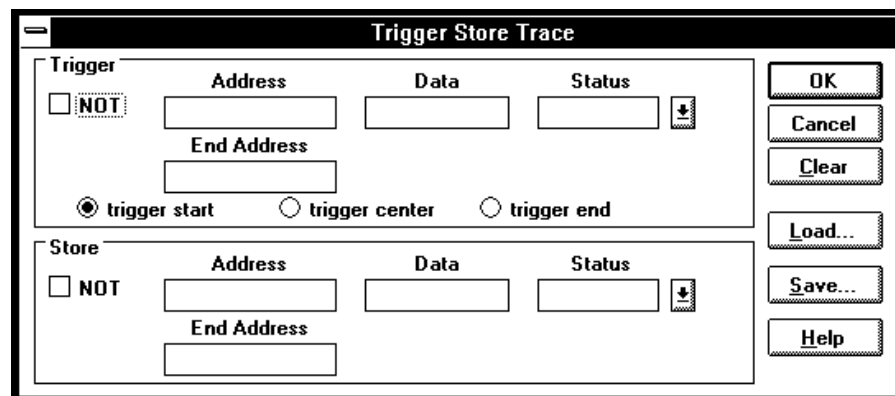

A group of Address, Data, and Status text boxes combine to form a *state qualifier*. You can specify an address range by entering a value in the End Address box. By selecting the NOT check box, you can specify all states other than those identified by the address, data, and *status values*.

Chapter 5: Debugging Programs
Setting Up Custom Trace Specifications

Example To trace execution after the "convert_case" function:
Choose the Trace→Trigger Store... (ALT, T, T) command.
Enter "convert_case" in the Address text box in the Trigger group box.

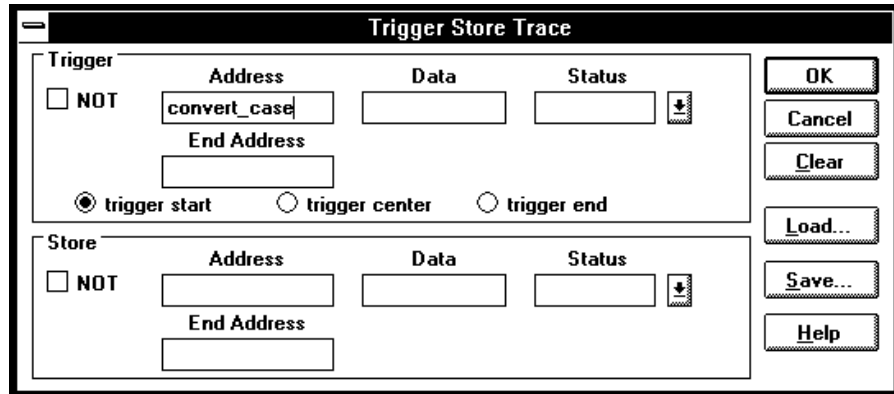

Choose the OK button.

Example To trace execution before and after the "convert_case" function and store only states with "write" status:

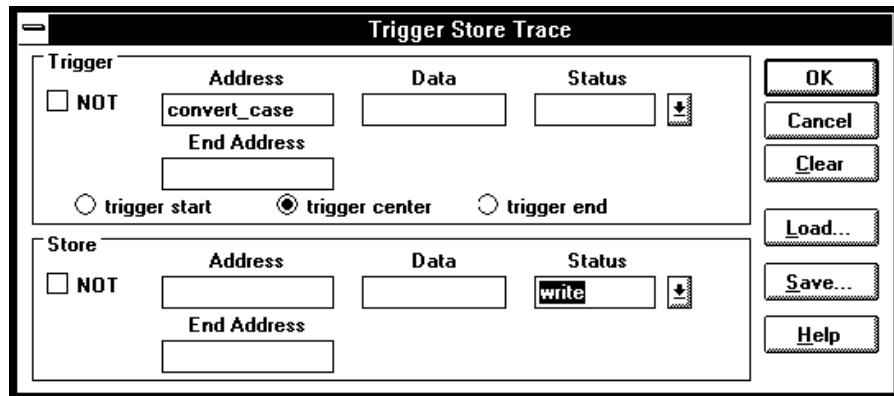

Example

To specify the trigger condition as any address in the range 1000h through 1fffh:

The image shows a dialog box titled "Trigger Store Trace". It is divided into two main sections: "Trigger" and "Store".

Trigger Section:

- There is a checkbox labeled "NOT" which is currently unchecked.
- Under the heading "Address", there is a text input field containing "1000".
- Under the heading "Data", there is an empty text input field.
- Under the heading "Status", there is an empty text input field and a small icon with a double-headed arrow.
- Under the heading "End Address", there is a text input field containing "1fff".
- At the bottom of this section, there are three radio buttons: "trigger start" (which is selected), "trigger center", and "trigger end".

Store Section:

- There is a checkbox labeled "NOT" which is currently unchecked.
- Under the heading "Address", there is an empty text input field.
- Under the heading "Data", there is an empty text input field.
- Under the heading "Status", there is an empty text input field and a small icon with a double-headed arrow.
- Under the heading "End Address", there is an empty text input field.

Buttons: On the right side of the dialog, there are six buttons: "OK", "Cancel", "Clear", "Load...", "Save...", and "Help".

To set up a "Find Then Trigger" trace specification

- 1 Choose the Trace→Find Then Trigger... (ALT, T, D) command.
- 2 Specify the sequence, which is made up of the *enable*, *trigger store*, *trigger*, and *store* conditions.
- 3 Specify the *restart*, *count*, and *prestore* conditions.
- 4 Specify the *trigger position* by selecting the trigger start, trigger center, or trigger end option.
- 5 If you want emulator execution to break to the monitor when the trigger condition occurs, select the *Break On Trigger* check box.
- 6 Choose the OK button to set up the analyzer and start the trace.

The Trace→Find Then Trigger... (ALT, T, D) command opens the Find then Trigger Trace dialog box:

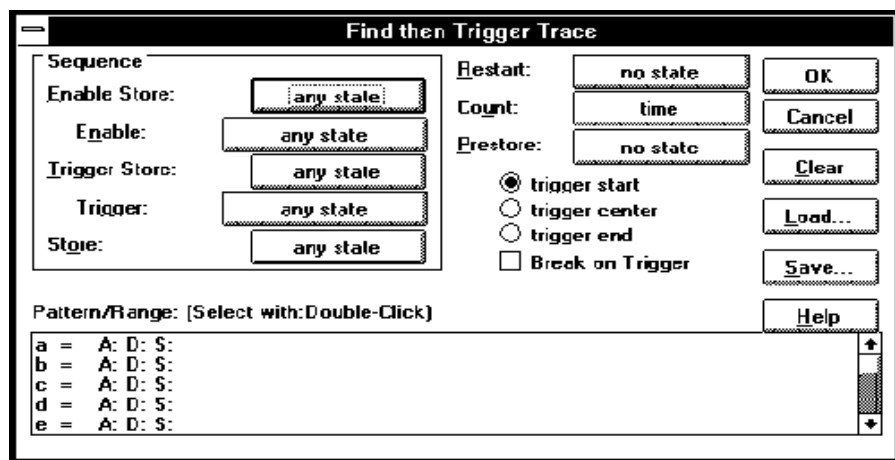

Choosing the enable, trigger, store, count, or prestore buttons opens a Condition dialog box that lets you select "any state", "no state", trace patterns

"a" through "h", "range", or "arm" as the condition. Patterns "a" through "h", "range", and "arm" are grouped into two sets, and resources within a set may be combined using the "or" or "nor" logical operators. Resources from the two sets may be combined using the OR or AND logical operators.

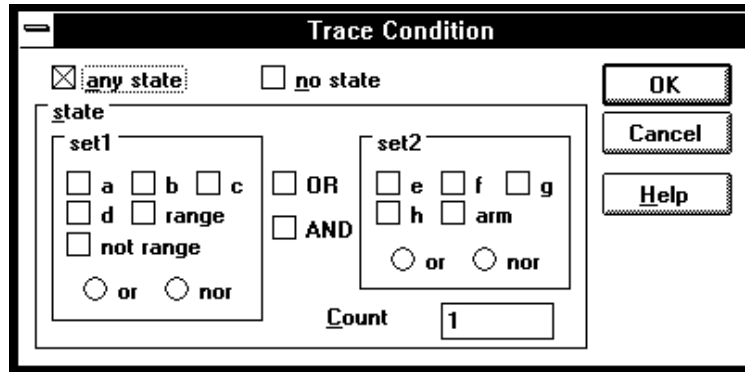

The range and pattern resources are defined by double-clicking on the resource name in the Pattern/Range list box.

If you double-click on a pattern name, the Trace Pattern dialog box is opened to let you specify address, data, and status values. By selecting the NOT check box, you can specify all states other than those identified by the address, data, and *status values*. The Direct check box lets you specify status values other than those that have been predefined.

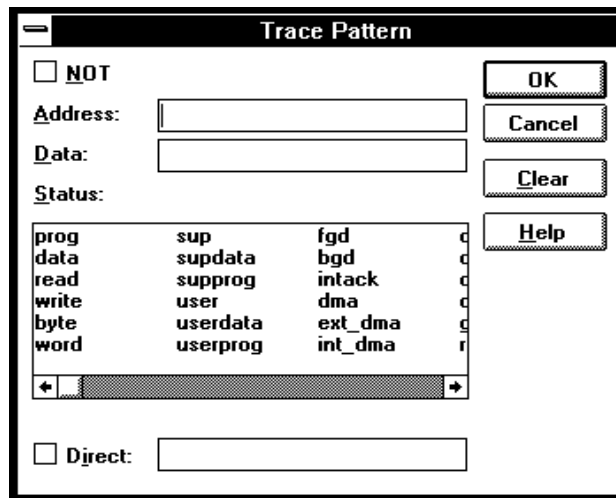

Chapter 5: Debugging Programs
Setting Up Custom Trace Specifications

If you double-click on the range resource (bottom of the Pattern/Range list box), the Trace Range dialog box is opened to let you select either the Address range or the Data range option and enter the minimum and maximum values in the range.

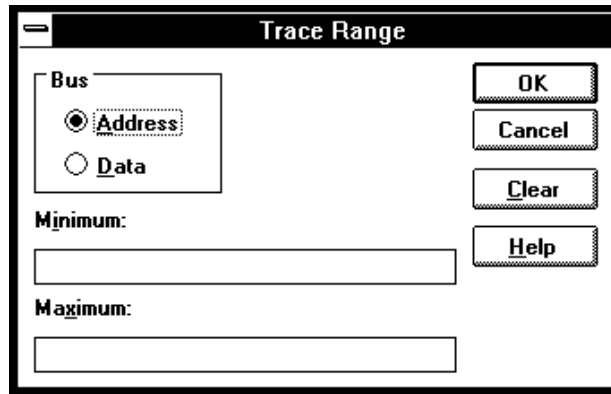

Example

To trace execution after the "convert_case" function:

Choose the Trace→Find Then Trigger... (ALT, T, D) command.

Choose the Trigger button (default: any state).

Select "a".

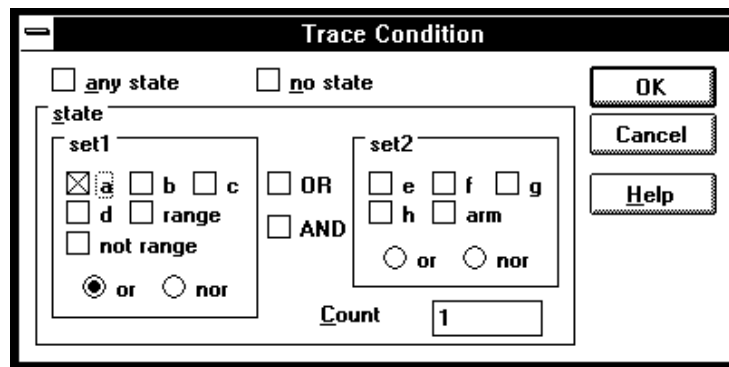

Choose the OK button.

Double-click "a" in the Pattern/Range list box.

Enter "convert_case" in the Address text box in the Trace Pattern dialog box.

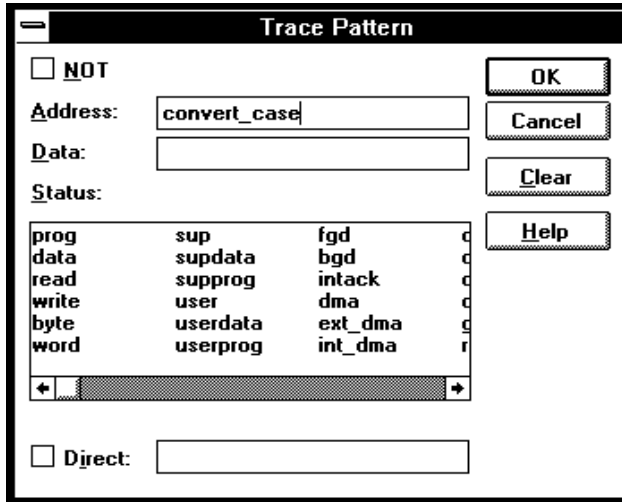

Choose the OK button in the Trace Pattern dialog box.

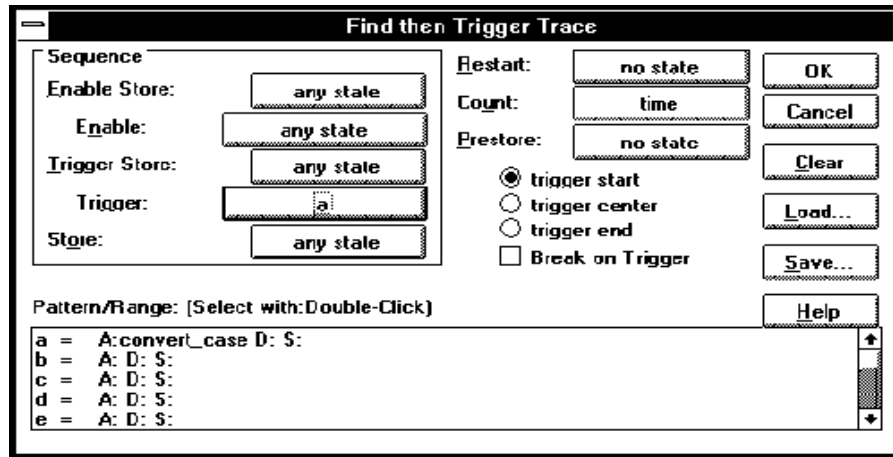

Choose the OK button in the Find then Trigger Trace dialog box.

Chapter 5: Debugging Programs
Setting Up Custom Trace Specifications

Example To trace about the "next_message" function when it follows the "change_status" function and store all states after the "change_status" function:

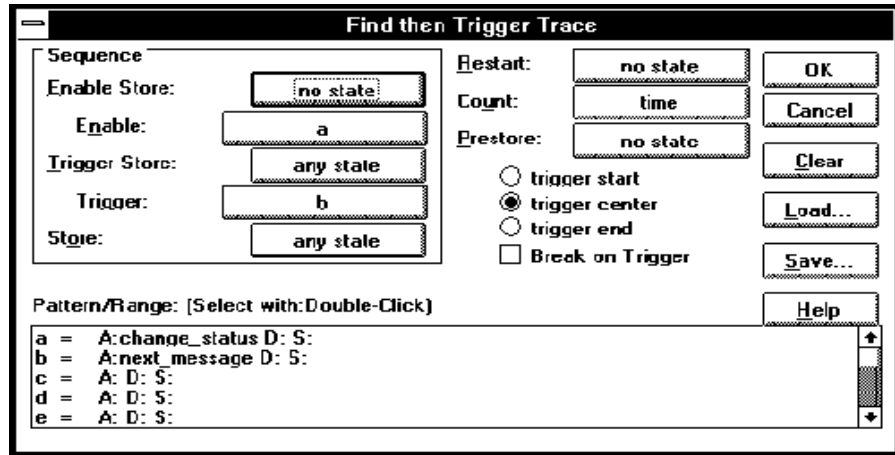

To set up a "Sequence" trace specification

Sequence trace specifications let you trigger the analyzer on a sequence of several captured states.

There are 8 sequence levels. When a trace is started, the first sequence level is active. You select one of the remaining sequence levels as the level that, when entered, will trigger the analyzer. Each level lets you specify two conditions that, when satisfied by a captured state, will cause branches to other levels:

```
if (state matches primary branch condition)
  then GOTO (level associated with primary branch)
else if (state matches secondary branch condition)
  then GOTO (level associated with secondary branch)
else
  stay at current level
```

Note that if a state matches both the primary and secondary branch conditions, the primary branch is taken.

Each sequence level also has a store condition that lets you specify the states that get stored while at that level.

- 1 Choose the Trace→Sequence... (ALT, T, Q) command.
- 2 Specify the *primary branch*, *secondary branch*, and *store* conditions for each *sequence level* you will use.
- 3 Specify which sequence level to trigger on. The analyzer triggers on the entry to the specified level. Therefore, the condition that causes a branch to the specified level actually triggers the analyzer.
- 4 Specify the *count* and *prestore* conditions.
- 5 Specify the *trigger position* by selecting the trigger start, trigger center, or trigger end option.

- 6 If you want emulator execution to break to the monitor when the trigger condition occurs, select the *Break On Trigger* check box.
- 7 Choose the OK button to set up the analyzer and start the trace.

The Trace→Sequence... (ALT, T, Q) command calls the Sequence Trace Setting dialog box, where you make the following trace specifications:

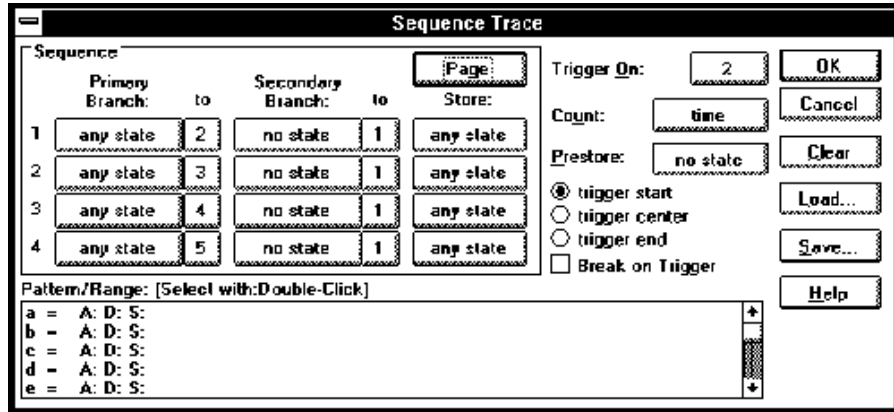

Choosing the primary branch, secondary branch, store, count, or prestore buttons opens a Condition dialog box that lets you select "any state", "no state", trace patterns "a" through "h", "range", or "arm" as the condition. Patterns "a" through "h", "range", and "arm" are grouped into two sets, and resources within a set may be combined using the "or" or "nor" logical operators. Resources in the two sets may be combined using the OR or AND logical operators.

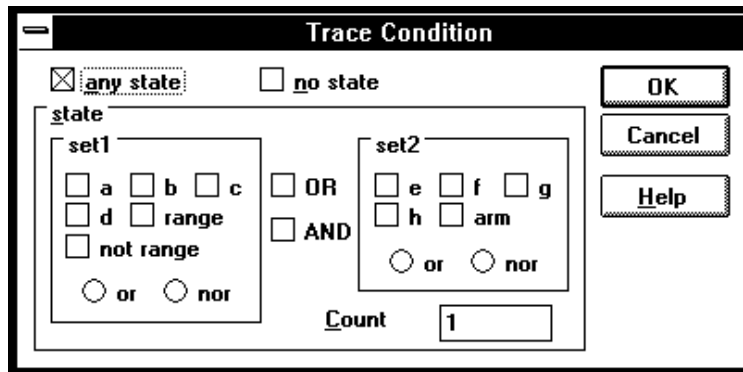

The range and pattern resources are defined by double-clicking on the resource name in the Pattern/Range list box.

If you double-click on a pattern name, the Trace Pattern dialog box is opened to let you specify address, data, and status values. By selecting the NOT check box, you can specify all states other than those identified by the address, data, and *status values*. The Direct check box lets you specify status values other than those that have been predefined.

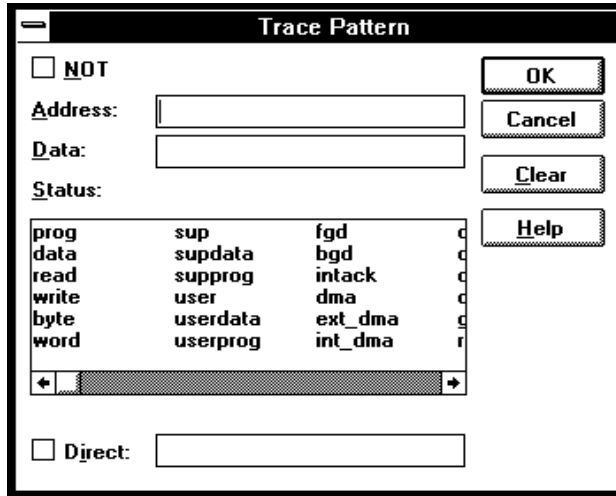

If you double-click on the range resource at the bottom of the Pattern/Range list box, the Trace Range dialog box is opened to let you select either the Address range option or the Data range option and enter the minimum and maximum values in the range.

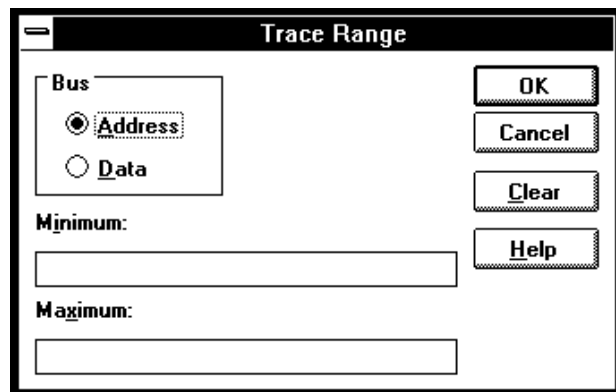

Chapter 5: Debugging Programs
Setting Up Custom Trace Specifications

Example To specify address "convert_case" as the trigger condition:

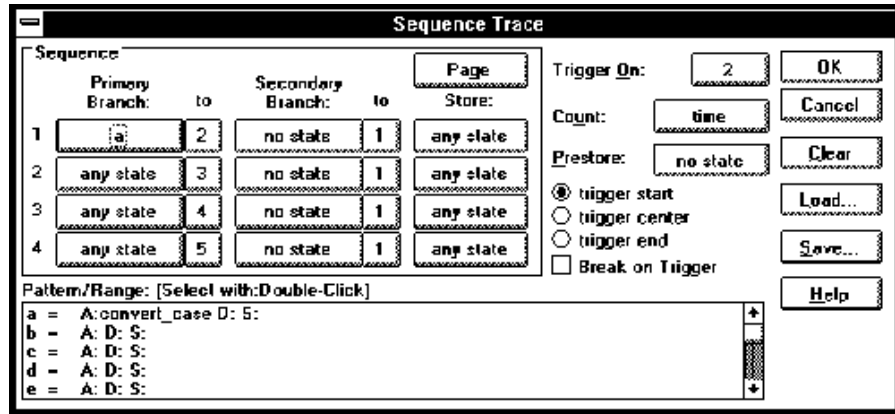

Example To specify execution of "convert_case" and "next_message" as the trigger sequence:

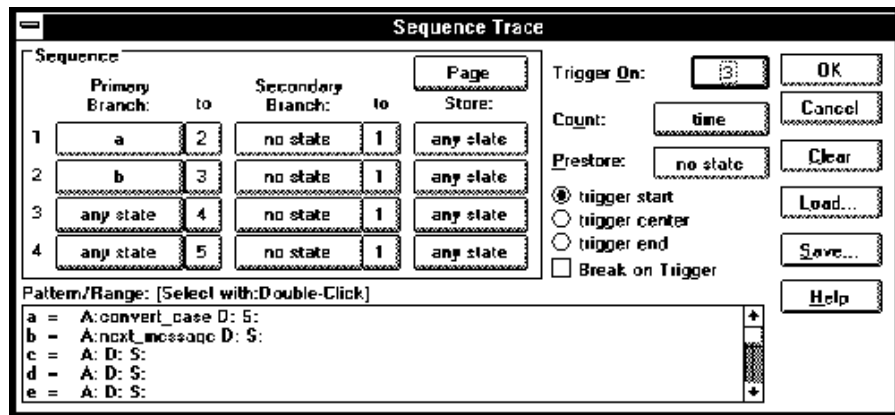

To edit a trace specification

- 1 Choose the Trace→Edit... (ALT, T, E) command.
- 2 Using the Sequence Trace dialog box, edit the trace specification as desired.
- 3 Choose the OK button.

You can use this command to edit trace specifications, including trace specifications that are automatically set up. For example, you can use this command to edit the trace specification that is set up when the Trace→Function Flow (ALT, T, F) command is chosen.

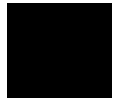

To trace "windows" of program execution

- 1 Because pairs of sequence levels are used to capture window enable and disable states both before and after the trigger, choose the Trace→Sequence... (ALT, T, Q) command.
- 2 Set up the sequence levels, patterns, and other trace options (as described below) in the Sequence Trace dialog box.
- 3 Choose the OK button.

When you trace "windows" of program execution, you store states that occur between one state and another state. Storing states that occur between two states is different from the trace specification set up by the Trace→Statement... (ALT, T, S) command, which stores states in a function's range of addresses.

In a typical windowing trace specification, sequence levels are paired. The first sequence level searches for the window enable state, and no states are stored while searching. When the window enable state is found, the second

Chapter 5: Debugging Programs
Setting Up Custom Trace Specifications

sequence level stores the states you're interested in while searching for the window disable state.

If you want to store the window of code execution before and after the trigger condition, use two sets of paired sequence levels: one window enable/disable pair of sequence levels before the trigger, and another disable/enable pair after the trigger as shown below.

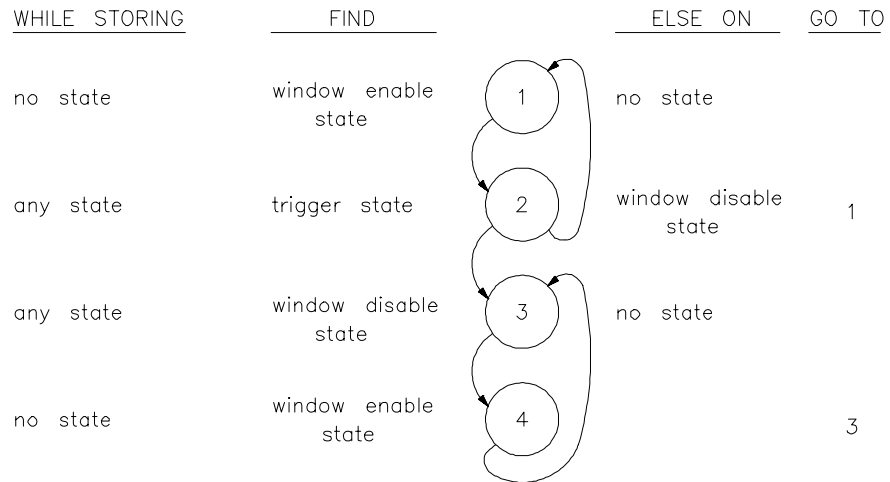

Notice that the order of the second sequence level pair is swapped. In sequence level 2, if the analyzer finds the trigger condition while searching for the window disable state, it will branch to sequence level 3 where it continues its search for the window disable state. After this, the analyzer will remain in sequence levels 3 and 4 until the trace memory is filled, completing the trace.

Example

To trace the window of code execution between lines 46 and 51 of the sample program, triggering on any state in the window:

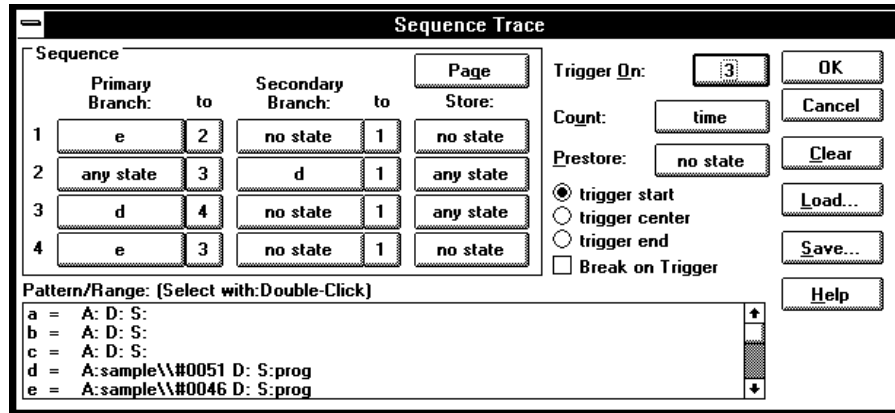

Notice that the analyzer triggers on the entry to sequence level 3. The primary branch condition in level 2 actually specifies the trigger condition.

To store the current trace specification

- 1 Choose the Trace→Edit... (ALT, T, E) command.
- 2 Choose the Save... button.
- 3 Specify the name of the trace specification file.
- 4 Choose the OK button.

You can also store trace specifications from the Trigger Store Trace, Find Then Trigger Trace, or Sequence Trace dialog boxes.

The extension for trace specification files defaults to ".TRC".

To load a stored trace specification

- 1** Choose the Trace→Trigger Store... (ALT, T, T), Trace→Find Then Trigger... (ALT, T, D), Trace→Sequence... (ALT, T, Q), or Trace→Edit... (ALT, T, E) command.
- 2** Choose the Load... button.
- 3** Select the desired trace specification file.
- 4** Choose the OK button.

A "Trigger Store" trace specification file can be loaded into any of the trace setting dialog boxes. A "Find Then Trigger" trace specification file can be loaded into either the Find Then Trigger Trace or Sequence Trace dialog boxes. A "Sequence" trace specification file can only be loaded into the Sequence Trace dialog box.

Part 3

Reference

Descriptions of the product in a dictionary or encyclopedia format.



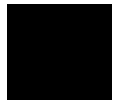

Command File and Macro Command Summary

Command File and Macro Command Summary

This section lists the Real-Time C Debugger break macro and command file commands, providing syntax and brief description for each of the listed commands. For details on each command, refer to the command descriptions.

The characters in parentheses can be ignored for shortcut entry.

Run Control Commands

Command	Param_1	Param_2	Param_3	Param_4	Operation
BRE(AK)					Breaking execution
COM(E)					Run to cursor-indicated line
OVE(R)					Stepping over
OVE(R)	count				Repeated a number of times
OVE(R)	count	address			From specified address
OVE(R)	count	STA(RT)			From transfer address
RES(ET)					Resetting processor
RET(URN)					Until return
RUN					From current address
RUN	address				From specified address
RUN	STA(RT)				From transfer address
RUN	RES(ET)				From reset
STE(P)					Stepping
STE(P)	count				Repeated a number of times
STE(P)	count	address			From specified address
STE(P)	count	STA(RT)			From transfer address

Variable and Memory Commands

Command	Param_1	Param_2	Param_3	Param_4	Operation
MEM(ORY)	address				Changing address displayed
MEM(ORY)	address	TO	value		Edit memory, display size
MEM(ORY)	size	address	TO	value	Edit memory, specify size
MEM(ORY)	FIL(L)	size	addr-range	value	Filling memory contents
MEM(ORY)	COP(Y)	size	addr-range	address	Copying memory contents
MEM(ORY)	IMA(GE)	size	addr-range		Copying target memory
MEM(ORY)	LOA(D)	MOT(OSREC)	filename		Loading memory from a Motorola S-record file
MEM(ORY)	LOA(D)	INT(ELHEX)	filename		Loading memory from an Intel Hexadecimal file
MEM(ORY)	STO(RE)	MOT(OSREC)	addr-range	filename	Storing memory to a Motorola S-record file
MEM(ORY)	STO(RE)	INT(ELHEX)	addr-range	filename	Storing memory to an Intel Hexadecimal file
MEM(ORY)	BYT(E)				Byte format display
MEM(ORY)	WOR(D)				16-Bit format display
MEM(ORY)	ABS(OLUTE)				Single-column display

Chapter 6: Command File and Macro Command Summary

MEM(ORY)	BLO(CK)				Multi-column display
MEM(ORY)	LON(G)				32-Bit format display
IO	SET	size	space	address	Registering I/O display
IO	DEL(ETE)	size	space	address	Deleting I/O display
IO	size	space	address	TO value	Editing I/O
VAR(IABLE)	address	TO	value		Editing variable
WP	SET	address			Registering watchpoint
WP	DEL(ETE)	address			Deleting watchpoint
WP	DEL(ETE)	ALL			Deleting all watchpoints

Breakpoint Commands

Command	Param_1	Param_2	Param_3	Param_4	Operation
MODE	BKP(TBREAK)	ON OFF			Deletes all/prevents new breakpoints
BM	SET	linenumber	command		Setting break macro
BM	SET	plinenum	command		Setting break macro
BM	DEL(ETE)	linenumber			Deleting break macro
BM	DEL(ETE)	plinenum			Deleting break macro
BP	SET	address			Setting breakpoint
BP	DEL(ETE)	address			Deleting breakpoint
BP	DEL(ETE)	ALL			Deleting breakpoint
BP	DISABLE	address			Disabling a breakpoint
BP	ENABLE	address			Enabling a breakpoint
EVA(LUATE)	address				Expression window display
EVA(LUATE)	"strings"				Printing string
EVA(LUATE)	CLE(AR)				Clearing Expression window

Window Open/Close Command

Command	Param_1	Param_2	Param_3	Param_4	Operation
DIS(PLAY)	window-name				Opening the named window
ICO(NIC)	window-name				Closing the named window

Configuration Command

Command	Param_1	Param_2	Param_3	Param_4	Operation
CON(FIG)	STA(RT)				Starting configuration
CON(FIG)	config-item	config-ans			Executing configuration
CON(FIG)	END				Ending configuration
MAP	STA(RT)				Starting mapping
MAP	addr-range	memtype	func-code	attribute	Executing mapping
MAP	OTHER	memtype	func-code		Mapping OTHER area
MAP	END				Ending mapping
MOD(E)	MNE(MONIC)	ON			Enabling Mnemonic display
MOD(E)	MNE(MONIC)	OFF			Enabling Source display
MOD(E)	REA(LTIME)	ON			Enabling real-time mode
MOD(E)	REA(LTIME)	OFF			Disabling real-time mode
MOD(E)	IOG(UARD)	ON			Enabling I/O guard
MOD(E)	IOG(UARD)	OFF			Disabling I/O guard
MOD(E)	MEM(ORYPOLL)	ON			Enabling Memory polling
MOD(E)	MEM(ORYPOLL)	OFF			Disabling Memory polling
MOD(E)	WAT(CHPOLL)	ON			Enabling WatchPoint polling
MOD(E)	WAT(CHPOLL)	OFF			Disabling WatchPoint polling
MOD(E)	LOG	ON			Enabling log file output
MOD(E)	LOG	OFF			Disabling log file output
MOD(E)	BNC	IN			Setting BNC input
MOD(E)	BNC	OUT			Setting BNC output
MOD(E)	SYM(BOLCASE)	ON			Case sensitive symbol search
MOD(E)	SYM(BOLCASE)	OFF			Case insensitive sym. search
MOD(E)	DOW(NLOAD)	ERR(ABORT)			Error causes load abort

Chapter 6: Command File and Macro Command Summary

MOD(E)	DOW(NLOAD)	NOE(RRABORT)	Load continues after error
MOD(E)	SOU(RCE)	ASK(PATH)	Prompt for source paths
MOD(E)	SOU(RCE)	NOA(SKPATH)	Don't prompt for src paths
MOD(E)	TRACECLOCK	BACKGROUND	Trace background cycles
MOD(E)	TRACECLOCK	BOTH	Trace all processor cycles
MOD(E)	TRACECLOCK	USER	Trace user program cycles

File Command

Command	Param_1	Param_2	Param_3	Param_4	Operation
FIL(E)	SOU(RCE)	modulename			Displaying source file
FIL(E)	OBJ(ECT)	filename	func-code		Loading object
FIL(E)	SYM(BOL)	filename	func-code		Loading symbol
FIL(E)	BIN(ARY)	filename	func-code		Loading data
FIL(E)	APPEND	filename	func-code		Appending symbol
FIL(E)	CHA(INCMD)	filename			Chaining command files
FIL(E)	COM(MAND)	filename			Executing command file
FIL(E)	LOG	filename			Specifying command log file
FIL(E)	RER(UN)				Re-executes command file
FIL(E)	CON(FIGURATION)	LOA(D)	filename		Loads config. from file
FIL(E)	CON(FIGURATION)	STO(RE)	filename		Stores configuration to file
FIL(E)	ENV(IRONMENT)	LOA(D)	filename		Loads environment from file
FIL(E)	ENV(IRONMENT)	SAV(E)	filename		Stores environment to file

Trace Commands

Command	Param_1	Param_2	Param_3	Param_4	Operation
TRA(CE)	FUN(CTION)	FLO(W)			Tracing function flow
TRA(CE)	FUN(CTION)	CAL(L)	funcname		Tracing function call
TRA(CE)	FUN(CTION)	STA(TEMENT)	funcname		Tracing statement
TRA(CE)	VAR(IABLE)	ACC(ESS)	address		Tracing access to variable
TRA(CE)	VAR(IABLE)	BRE(AK)	address	value	Setting breakpoint variable
TRA(CE)	STO(P)				Stopping tracing
TRA(CE)	ALW(AYS)				Tracing until halt
TRA(CE)	AGA(IN)				Restarting tracing
TRA(CE)	SAV(E)	filename			Storing trace specification
TRA(CE)	LOA(D)	filename			Loading trace specification
TRA(CE)	CUS(TOMIZE)				Starts trace w/loaded spec.
TRA(CE)	DIS(PLAY)	MIX(ED)			Enabling source+bus display
TRA(CE)	DIS(PLAY)	SOU(RCE)			Enabling source display
TRA(CE)	DIS(PLAY)	BUS			Enabling bus display
TRA(CE)	DIS(PLAY)	ABS(OLUTE)			Displaying absolute time
TRA(CE)	DIS(PLAY)	REL(ATIVE)			Displaying relative time
TRA(CE)	COP(Y)	DISPLAY			Copying trace display
TRA(CE)	COP(Y)	ALL			Copying trace results
TRA(CE)	FIN(D)	TRI(GGER)			Centers trigger in window
TRA(CE)	FIN(D)	STA(TE)	state-num		Centers state in window
TRA(CE)	COP(Y)	SPE(C)			Copying specification

Symbol Window Commands

Command	Param_1	Param_2	Param_3	Param_4	Operation
SYM(BOL)	LIS(T)	MOD(ULE)			Displaying module
SYM(BOL)	LIS(T)	FUN(CTION)			Displaying function
SYM(BOL)	LIS(T)	EXT(ERNAL)			Displaying global symbol
SYM(BOL)	LIS(T)	INT(ERNAL)	funcname		Displaying local symbol
SYM(BOL)	LIS(T)	GLO(BAL)			Displaying global asm symbol
SYM(BOL)	LIS(T)	LOC(AL)	modulename		Displaying local asm symbol
SYM(BOL)	ADD	usersymbol	address		Adding user-defined symbol
SYM(BOL)	DEL(ETE)	usersymbol			Deleting user-defined symbol
SYM(BOL)	DEL(ETE)	ALL			Deleting all user symbols

Chapter 6: Command File and Macro Command Summary

SYM(BOL)	MAT(CH)	"strings"	Displaying matched string
SYM(BOL)	COP(Y)	DIS(PLAY)	Copying symbol display
SYM(BOL)	COP(Y)	ALL	Copying all symbols

Command File Control Command

Command	Param_1	Param_2	Param_3	Param_4	Operation
EXIT					Exiting command file
EXIT	VAR(IABLE)	address	value		Exiting with variable cont.
EXIT	REG(ISTER)	regname	value		Exiting with register cont.
EXIT	MEM(ORY)	size	address	value	Exiting with memory contents
EXIT	IO	BYTE/WORD	address	value	Exiting with I/O contents
WAIT	MON(ITOR)				Wait until MONITOR status
WAIT	RUN				Wait until RUN status
WAIT	UNK(NOWN)				Wait until UNKNOWN status
WAIT	SLO(W)				Wait until SLOW CLOCK status
WAIT	TGT(RESET)				Wait until TARGET RESET
WAIT	SLE(EP)				Wait until SLEEP status
WAIT	GRA(NT)				Wait until BUS GRANT status
WAIT	NOB(US)				Wait until NOBUS status
WAIT	TCO(M)				Wait until end of trace
WAIT	THA(LT)				Wait until halt
WAIT	TIM(E)	seconds			Wait a number of seconds

Miscellaneous Commands

Command	Param_1	Param_2	Param_3	Param_4	Operation
ASM	address	usersymbol	"inst-string"		In-line assembler
BEE(P)					Sounding beep
BUTTON	label	"command"			Adds button to Button window
BUTTON	DELETE	label			Deletes button from Button window
BUTTON	DELETEALL				Deletes all buttons from Button window
QUI(T)					Exiting debugger
COP(Y)	TO	filename			Specifying copy destination
COP(Y)	SOU(RCE)				Copying Source window
COP(Y)	REG(ISTER)				Copying Register window
COP(Y)	MEM(ORY)				Copying Memory window
COP(Y)	WAT(CHPOINT)				Copying WatchPoint window
COP(Y)	BAC(KTRACE)				Copying BackTrace window
COP(Y)	IO				Copying I/O window
COP(Y)	EXP(RESSION)				Copying Expression window
CUR(SOR)	address				Positioning cursor
CUR(SOR)	PC				Finding current PC
DIR(ECTORY)	directoryname				Directory for source search
NOP					Non-operative
REG(ISTER)	regname	TO	value		Editing register contents
SEA(RCH)	STR(ING)	direction	case	strings	Searching string
SEA(RCH)	FUN(CTION)	funcname			Selecting function
SEA(RCH)	MEM(ORY)	size	addr-range	value	Searching memory
SEA(RCH)	MEM(ORY)	STR(ING)	"strings"		Searching memory for string
TER(MCOM)	ti-command				Terminal Interface command

Chapter 6: Command File and Macro Command Summary

Parameters

Parameter	Description	Notation
address	Address	See "Reference".
addr-range	Address range	
attribute	Memory map attributes	See "Reference".
case	Case sensing	
command	Macro command	Commands listed in the "Reference".
config-ans	Setting	See "Reference".
config-item	Configuration	See "Reference".
count	Count	Decimal notation
direction	Search direction	
directoryname	Directory name	
filename	File name	
format	Memory file format	
funcname	Function name	
func-code	Function code	
label	Button label	
linenumber	Line number	
mentype	Memory type	
modulename	Module name	
plinenum	Macro line number	line number.macro number (ex. 34.1)
regname	Register name	
seconds	Time in seconds	
size	Data size	
space	Memory or I/O space	
strings	String	"string"
usersymbol	User-defined symbol	See "Reference".
value	Value	See "Reference".
window-name	Window name (1st 3 characters)	See "Reference."

WAIT Command Dialog Box

This dialog box appears when the WAIT command is included in a command file, break macro, or button.

Choosing the STOP button cancels the WAIT command.

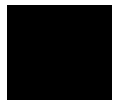

Expressions in Commands

Expressions in Commands

When you enter values and addresses in commands, you can use:

- Numeric constants (hexadecimal, decimal, octal, or binary values).
- Symbols (identifiers).
- Function codes.
- C operators (pointers, arrays, structures, unions, unary minus operators) and parentheses (specifying the order of operator evaluation).

Numeric Constants

All numeric constants are assumed to be hexadecimal, except when the number refers to a count; count values are assumed to be decimal. By appending a suffix to the numeric value, you can specify its base.

The debugger expressions support the following numeric constants with or without radix:

Hexadecimal	Alphanumeric strings starting with "0x" or "0X" and consisting of any of '0' through '9', 'A' through 'F', or 'a' through 'f' (for example: 0x12345678, 0xFFFF0000).
	Alphanumeric strings starting with any of '0' through '9', ending with 'H' or 'h', and consisting of any of '0' through '9', 'A' through 'F', or 'a' through 'f' (for example: 12345678H, 0FFFF0000h).
	Alphanumeric strings starting with any of '0' through '9' and consisting of any of '0' through '9', 'A' through 'F', or 'a' through 'f' (for example: 12345678, 0FFFF0000).
	Hexadecimal strings starting with alphabetical characters must be preceded by 0. For example, FF40H must be entered as 0FF40H.
Decimal	Numeric strings consisting of any of '0' through '9' and ending with 'T' or 't' (for example: 128T, 1000t).
Octal	Numeric strings consisting of any of '0' through '7' and ending with 'O' or 'o' (not zero) (for example: 200o, 377O).
Binary	Numeric strings consisting of '0' or '1' and ending with 'Y' or 'y' (for example: 10000000y, 11001011Y).
Don't Care	Numeric strings containing 'X' or 'x' values. All numeric strings must begin with a numeric value. For example, x1x0y must be entered as 0x1x0y.

The symbol names can also include either * or & to explicitly specify the evaluation of the symbol.

Symbol address &symbol_name

Symbol data *symbol_name

Format Specification

The format specifications define the variable display format or size for the variable access or break tracing:

String s

Decimal d (current size), d8 (8 bit), d16 (16 bit), d32 (32 bit)

Unsigned decimal u (current size), u8 (8 bit), u16 (16 bit), u32 (32 bit)

Hexadecimal x (current size), x8 (8 bit), x16 (16 bit), x32 (32 bit)

Examples

Some example symbol expressions are shown below:

```
sample\|#22,x32
```

Display the address of line number 22 in the module "sample," formatted as a 32-bit hex number. This form (with the format specification) is used in the watchpoint window, expression window, etc.

```
sample\|#22
```

Refer to the address of line number 22 in the module "sample." This form (without the format specification) is used in the trace specification, memory display window, etc.

```
data[2].message,s
```

Display the structure element "message" in the third element of the array "data" as a string.

Chapter 7: Expressions in Commands
Symbols

`dat→message,s`

Display the structure element "message" pointed to by the "dat" pointer as a string.

`dat→message,x32`

Display the structure element "message" pointed to by the "dat" pointer as a 32-bit hex number.

`sample\\data[1].status,d32`

Display the structure element "status" in the second element of the array "data" that is in the module "sample" as a 32-bit decimal integer.

`&data[0]`

Refer to the address of the first element of the array "data."

`*1000`

Does not do anything. (It displays dashes, as an indication of a parsing error.) Note that you cannot use constants as an address.

Function Codes

Addresses can be specified with any of the *function codes*. The function codes are appended to the addresses, preceded by @ (for example: 0a3bc@up).

You must include a function code when referring to an address that was mapped with a function code other than X. This general rule is true except when:

- Specifying addresses in trace commands (because address qualifiers are compared with values captured on the address bus -- function code information is captured as part of the bus cycle status).
- Referring to a program counter address (because the function code is determined by the Supervisor/User status flag bit).

C Operators

The debugger expressions support the following C operators. The order of operator evaluation can be modified using parentheses '(' and '); however, it basically follows C conventions:

Pointers	'*' and '&'
Arrays	'[' and ']'
Structures or unions	'.' and '->'
Unary minus	'-'



Menu Bar Commands

Menu Bar Commands

This chapter describes the commands that can be chosen from the menu bar. Command descriptions are in the order they appear in the menu bar (top to bottom, left to right).

- File→Load Object... (ALT, F, L)
- File→Command Log→Log File Name... (ALT, F, C, N)
- File→Command Log→Logging ON (ALT, F, C, O)
- File→Command Log→Logging OFF (ALT, F, C, F)
- File→Run Cmd File... (ALT, F, R)
- File→Load Debug... (ALT, F, D)
- File→Save Debug... (ALT, F, S)
- File→Load Emulator Config... (ALT, F, E)
- File→Save Emulator Config... (ALT, F, V)
- File→Copy Destination... (ALT, F, P)
- File→Exit (ALT, F, X)
- File→Exit HW Locked (ALT, F, H)
- Execution→Run (ALT, E, U)
- Execution→Run to Cursor (ALT, R C)
- Execution→Run to Caller (ALT, E, T)
- Execution→Run... (ALT, E, R)
- Execution→Single Step (ALT, E, N)
- Execution→Step Over (ALT, E, O)
- Execution→Step... (ALT, E, S)
- Execution→Break (ALT, E, B)
- Execution→Reset (ALT, E, E)
- Breakpoint→Set at Cursor (ALT, B, S)
- Breakpoint→Delete at Cursor (ALT, B, D)
- Breakpoint→Set Macro... (ALT, B, M)
- Breakpoint→Delete Macro (ALT, B, L)
- Breakpoint→Edit... (ALT, B, E)
- Variable→Edit... (ALT, V, E)
- Trace→Function Flow (ALT, T, F)
- Trace→Function Caller... (ALT, T, C)
- Trace→Function Statement... (ALT, T, S)

- Trace→Variable Access... (ALT, T, V)
- Trace→Variable Break... (ALT, T, B)
- Trace→Edit... (ALT, T, E)
- Trace→Trigger Store... (ALT, T, T)
- Trace→Find Then Trigger... (ALT, T, D)
- Trace→Sequence... (ALT, T, Q)
- Trace→Until Halt (ALT, T, U)
- Trace→Halt (ALT, T, H)
- Trace→Again (ALT, T, A)
- RealTime→Monitor Intrusion→Disallowed (ALT, R, T, D)
- RealTime→Monitor Intrusion→Allowed (ALT, R, T, A)
- RealTime→I/O Polling→ON (ALT, R, I, O)
- RealTime→I/O Polling→OFF (ALT, R, I, F)
- RealTime→Watchpoint Polling→ON (ALT, R, W, O)
- RealTime→Watchpoint Polling→OFF (ALT, R, W, F)
- RealTime→Memory Polling→ON (ALT, R, M, O)
- RealTime→Memory Polling→OFF (ALT, R, M, F)
- Assemble... (ALT, A)
- Settings→Emulator Config→Hardware... (ALT, S, E, H)
- Settings→Emulator Config→Memory Map... (ALT, S, E, M)
- Settings→Emulator Config→Information... (ALT, S, E, I)
- Settings→Communication... (ALT, S, C)
- Settings→BNC→Outputs Analyzer Trigger (ALT, S, B, O)
- Settings→BNC→Input to Analyzer Arm (ALT, S, B, I)
- Settings→Font... (ALT, S, F)
- Settings→Tabstops... (ALT, S, T)
- Settings→Symbols→Case Sensitive→ON (ALT, S, S, C, O)
- Settings→Symbols→Case Sensitive→OFF (ALT, S, S, C, F)
- Settings→Extended→Trace Cycles→User (ALT, S, X, T, U)
- Settings→Extended→Trace Cycles→Monitor (ALT, S, X, T, M)
- Settings→Extended→Trace Cycles→Both (ALT, S, X, T, B)
- Settings→Extended→Load Error Abort→ON (ALT, S, X, L, O)
- Settings→Extended→Load Error Abort→OFF (ALT, S, X, L, F)
- Settings→Extended→Source Path Query→ON (ALT, S, X, S, O)
- Settings→Extended→Source Path Query→OFF (ALT, S, X, S, F)
- Window→Cascade (ALT, W, C)
- Window→Tile (ALT, W, T)
- Window→Arrange Icons (ALT, W, A)



Chapter 8: Menu Bar Commands

- Window→1-9 <win_name> (ALT, W, 1-9)
- Window→More Windows... (ALT, W, M)
- Help→About Debugger/Emulator... (ALT, H, D)

File→Load Object... (ALT, F, L)

Loads the specified object file and symbolic information into the debugger.

Program code is loaded into emulation memory or target system RAM.

Object files must be IEEE-695 format absolute files. Some software development tools that generate this format are:

Microtec MCC68K Compiler

Microtec ASM68K Assembler

Microtec LNK68K Linker

HP AxLS CC68000 Compiler

HP AxLS AS68K Assembler

HP AxLS LD68K Linker

You can also load Motorola S-Record and Intel Hexadecimal format files; however, no symbolic information from these files will be loaded.

Load Object File Dialog Box

Choosing the File→Load Object... (ALT, F, L) command opens the following dialog box:

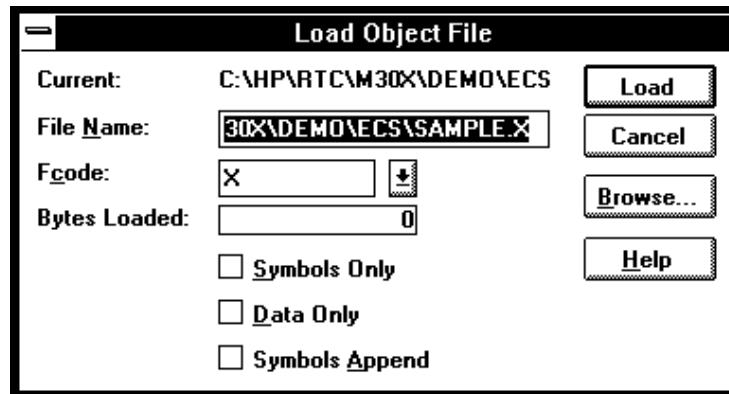

Current	Shows the currently loaded object file.
File Name	Specifies the object file to be loaded. The system defaults the file extension to ".x".
Fcode	Assigns any of the <i>function codes</i> to the destination memory area.
Bytes Loaded	Displays the loaded data in Kbytes.
Symbols Only	Loads only the symbolic information. This is used when programs are already in memory (for example, when the debugger is exited and reentered without turning OFF power to the target system or when code is in target system ROM).
Data Only	Loads program code but not symbols.
Symbols Append	Appends the symbols from the specified object file to the currently loaded symbols. This lets you debug code loaded from multiple object files.
Load	Starts loading the specified object file and closes the dialog box.
Cancel	Closes the dialog box without loading the object file.
Browse...	Opens a file selection dialog box from which you can select the object file to be loaded.

Command File Command

`FIL(E) OBJ(ECT) file_name func_code`

Loads the specified object file and symbols into the debugger.

`FIL(E) SYM(BOL) file_name func_code`

Loads only the symbolic information from the specified object file.

`FIL(E) BIN(ARY) file_name func_code`

Loads only the program code from the specified object file.

`FIL(E) APP(END) file_name func_code`

Appends the symbol information from the specified object file to the currently loaded symbol information.

See Also

"To load user programs" in the "Loading and Displaying Programs" section of the "Debugging Programs" chapter.



File→Command Log→Log File Name... (ALT, F, C, N)

Lets you name a new command log file.

The current command log file is closed and the specified command log file is opened. The default command log file name is "log.cmd".

Command log files can be executed with the File→Run Cmd File... (ALT, F, R) command.

The File→Command Log→Logging OFF (ALT, F, C, F) command stops the logging of executed commands.

This command opens a file selection dialog box from which you can select the command log file. Command log files have a ".CMD" extension.

Command File Command

FIL(E) LOG filename

See Also

"To create a command file" in the "Using Command Files" section of the "Using the Debugger Interface" chapter.

File→Command Log→Logging ON (ALT, F, C, O)

Starts command log file output.

The File→Command Log→Log File Name... (ALT, F, C, N) command specifies the destination file.

Command File Command

MOD(E) LOG ON

See Also

"To create a command file" in the "Using Command Files" section of the "Using the Debugger Interface" chapter.



File→Command Log→Logging OFF (ALT, F, C, F)

Stops command log file output.

The File→Command Log→Log File Name... (ALT, F, C, N) command specifies the destination file.

Command File Command

```
MOD(E) LOG OFF
```

See Also

"To create a command file" in the "Using Command Files" section of the "Using the Debugger Interface" chapter.

File→Run Cmd File... (ALT, F, R)

Executes the specified command file.

Command files can be:

- Files created with the File→Command Log→Log File Name... (ALT, F, C, N) command.
- Configuration files having .CMD extension.

Command files are stored as ASCII text files so they can be created or edited with ASCII text editors.

Command File Execution Dialog Box

Choosing the File→Run Cmd File... (ALT, F, R) command opens the following dialog box:

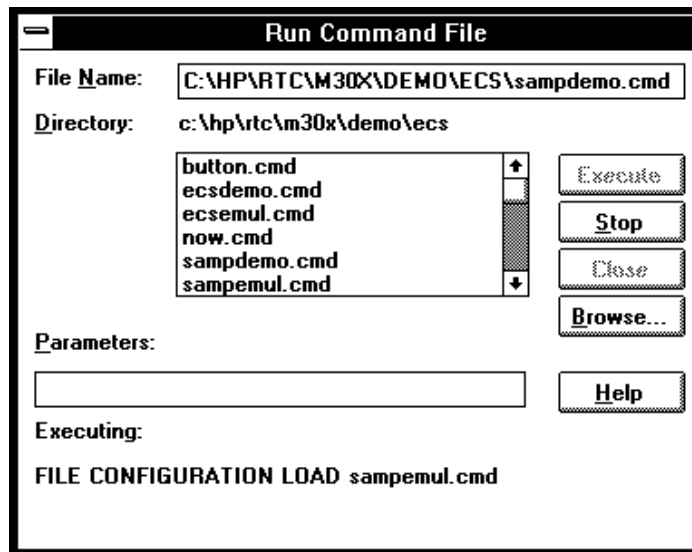

File Name	Lets you enter the name of the command file to be executed.
Directory	Shows the current directory and the command files in that directory. You can select the command file name from this list.
Parameters	Lets you specify up to five parameters that replace placeholders \$1 through \$5 in the command file. Parameters must be separated by blank spaces.
Executing	Shows the command being executed.
Execute	Executes the command file.
Stop	Stops command file execution.
Close	Closes the dialog box.
Browse...	Opens a file selection dialog box from which you can select the command file name.

Command File Command

`FIL(E) COM(MAND) filename args`

See Also

"To execute a command file" in the "Using Command Files" section of the "Using the Debugger Interface" chapter.

File→Load Debug... (ALT, F, D)

Loads a debug environment file.

This command opens a file selection dialog box from which you select the debug environment file.

Debug environment files have the extension ".ENV".

Debug environment files contain information about:

- Breakpoints.
- Variables in the WatchPoint window.
- The directory that contains the currently loaded object file.

Command File Command

`FIL(E) ENV(IRONMENT) LOA(D) filename`



File→Save Debug... (ALT, F, S)

Saves a debug environment file.

This command opens a file selection dialog box from which you select the debug environment file.

The following information is saved in the debug environment file:

- Breakpoints.
- Variables in the WatchPoint window.
- The directory that contains the currently loaded object file.

Command File Command

```
FIL(E) ENV(IRONMENT) SAV(E) filename
```

File→Load Emulator Config... (ALT, F, E)

Loads a hardware configuration command file.

This command opens a file selection dialog box from which you select the hardware configuration file.

Emulator configuration command files contain:

- Hardware configuration settings.
- Memory map configuration settings.
- Monitor configuration settings.

Command File Command

```
FIL(E) CON(FIGURATION) LOA(D) filename
```

See Also

"To load an emulator configuration" in the "Saving and Loading Configurations" section of the "Configuring the Emulator" chapter.



File→Save Emulator Config... (ALT, F, V)

Saves the current hardware configuration to a command file.

The following information is saved in the emulator configuration file:

- Hardware configuration settings.
- Memory map configuration settings.
- Monitor configuration settings.

Command File Command

```
FIL(E) CON(FIGURATION) STO(RE) filename
```

See Also

"To save the current emulator configuration" in the "Saving and Loading Configurations" section of the "Configuring the Emulator" chapter.

File→Copy Destination... (ALT, F, P)

Names the listing file to which debugger information may be copied.

The contents of most of the debugger windows can be copied to the destination listing file by choosing the Copy→Window command from the window's control menu.

The Symbol and Trace windows' control menus provide the Copy→All command for copying all of the symbolic or trace information to the destination listing file.

This command opens a file selection dialog box from which you select the name of the output list file. Output list files have the extension ".LST".

Command File Command

COP(Y) TO filename

See Also

"To change the list file destination" in the "Working with Debugger Windows" section of the "Using the Debugger Interface" chapter.

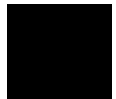

File→Exit (ALT, F, X)

Exits the debugger.

Command File Command

QUI (T)

See Also

"To exit the debugger" in the "Starting and Exiting the Debugger" section of the "Using the Debugger Interface" chapter.

File→Exit HW Locked (ALT, F, H)

File→Exit HW Locked (ALT, F, H)

Exits the debugger and locks the emulator hardware.

When the emulator hardware is locked, your user name and ID are saved in the HP 64700 and other users are prevented from accessing it.

You can restart the debugger and resume your debug session after reloading the symbolic information with the File→Load Object... (ALT, F, L) command.

If you have any breakpoints set when you exit the debugger, you will have to reset the breakpoints when you restart the debugger. All breakpoints are deleted when RTC is exited.

Command File Command

QUI (T) LOC (KED)

See Also

Settings→Communication... (ALT, S, C)



File Selection Dialog Boxes

File selection dialog boxes are used with several of the debugger commands. An example of a file selection dialog box is shown below.

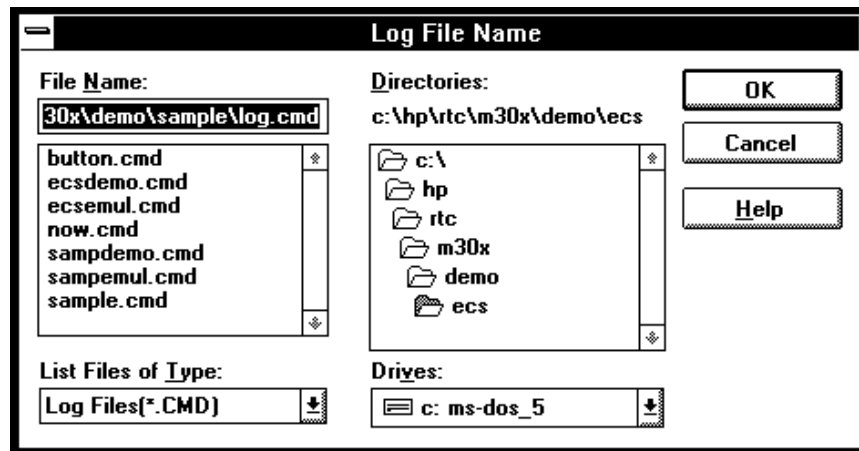

File Name	You can select the name of the file from the list box and edit it in the text box.
List Files of Type	Lets you choose the filter for files shown in the File Name list box.
Directories	You can select the directory from the list box. The selected directory is shown above the list box.
Drives	Lets you select the drive name whose directories are shown in the Directories list box.
OK	Selects the named file and closes the dialog box.
Cancel	Cancels the command and closes the dialog box.
Help	If this button is available, it opens a help window for viewing the associated help information.

Execution→Run (F5), (ALT, E, U)

Runs the program from the current program counter address.

Command File Command

RUN



Execution→Run to Cursor (ALT, E, C)

Runs from the current program counter address up to the Source window line that contains the cursor.

This command sets a breakpoint at the cursor-selected source line and runs from the current program counter address; therefore, it cannot be used when programs are in target system ROM.

If the cursor-selected source line is not reached within the number of milliseconds specified by StepTimerLen in the B3638.INI file, a dialog box appears from which you can cancel the command. When the Stop button is chosen, program execution stops, the breakpoint is deleted, and the processor continues RUNNING IN USER PROGRAM.

Command File Command

COM(E) address

See Also

"To run the program until the specified line" in the "Stepping, Running, and Stopping" section of the "Debugging Programs" chapter.

Execution→Run to Caller (ALT, E, T)

Executes the user program until the current function returns to its caller.

Because this command determines the address at which to stop execution based on stack frame data and object file function information, the following restrictions are imposed:

- A function cannot properly return immediately after its entry point because the stack frame for the function has not yet been generated. Use the Step command to single-step the function before using the Execution→Run to Caller (ALT, E, T) command.
- An assembly language routine cannot properly return, even it follows C function call conventions, because there is no function information in the object file.
- An interrupt function cannot properly return because it uses a stack in a different fashion from standard functions.

Command File Command

RET (URN)

See Also

"To run the program until the current function return" in the "Stepping, Running, and Stopping" section of the "Debugging Programs" chapter.



Execution→Run... (ALT, E, R)

Executes the user program starting from the specified address.

This command sets the processor status to RUNNING IN USER PROGRAM.

Note

If you try to run from an address whose symbol is START, STA, RESET, or RES (or any upper- or lower-case variation), the debugger instead runs from the start address or reset address, respectively, because these are the keywords used with the RUN command. To fix this problem, use START+0, STA+0, RESET+0, or RES+0 to force the symbol to be evaluated as an address.

Run Dialog Box

Choosing the Execution→Run... (ALT, E, R) command opens the following dialog box:

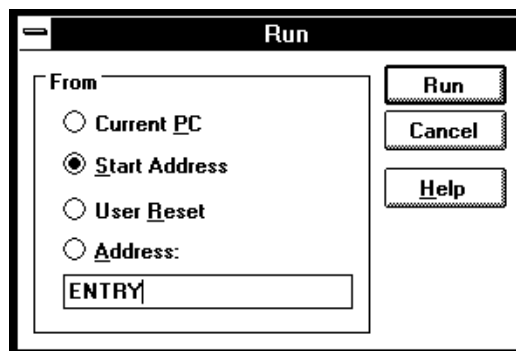

Current PC Specifies that the program run from the current program counter address.

Start Address Specifies that the program run from the *transfer address* defined in the object file.

User Reset	The emulator drives the target reset line and begins executing from the contents of exception vector 0 (this will occur within a few cycles of the /RESET signal).
Address	Lets you enter the address from which to run. Because the function code is determined from the memory map, do not include one with the address.
Run	Initiates program execution from the specified address, then close the dialog box.
Cancel	Cancels the command and closes the dialog box.

Command File Command

`RUN`

Executes the user program from the current program counter address.

`RUN STA(RT)`

Executes the user program from the transfer address defined in the object file.

`RUN RES(ET)`

Drives the target reset line and begins executing from the contents of exception vector 0.

`RUN address`

Executes the user program from the specified address.

See Also

"To run the program from a specified address" in the "Stepping, Running, and Stopping" section of the "Debugging Programs" chapter.

Execution→Single Step (F2), (ALT, E, N)

Executes a single instruction or source line at the current program counter address.

A single source line is executed when in the source only display mode, unless no source is available or an assembly language program is loaded; in these cases, a single assembly language instruction is executed.

When in the mnemonic mixed display mode, a single assembly language instruction is executed.

Command File Command

STE (P)

See Also

"To step a single line or instruction" in the "Stepping, Running, and Stopping" section of the "Debugging Programs" chapter.

Execution→Step Over (ALT, E, O)

Execution→Step... (ALT, E, S)

Execution→Step Over (F3), (ALT, E, O)

Executes a single instruction or source line at the current program counter except when the instruction or source line makes a subroutine or function call, in which case the entire subroutine or function is executed.

This command is the same as the Execution→Single Step (ALT, E, N) command except when the source line contains a function call or the assembly instruction makes a subroutine call (with the BSR or JSR instructions). In these cases, the entire function or subroutine is executed.

Command File Command

OVE (R)

See Also

"To step over a function" in the "Stepping, Running, and Stopping" section of the "Debugging Programs" chapter.



Execution→Step... (ALT, E, S)

Single-steps the specified number of instructions or source lines, starting from the specified address.

Single source lines are executed when in the source only display mode, unless no source is available or an assembly language program is loaded; in these cases, single assembly language instructions are executed.

When in the mnemonic mixed display mode, single assembly language instructions are executed.

Note

If you try to step from an address whose symbol is `START` or `STA` (or any upper- or lower-case variation), the debugger instead steps from the start address because these are the keywords used with the `STEP` and `OVER` commands. To fix this problem, use `START+0` or `STA+0` to force the symbol to be evaluated as an address.

Step Dialog Box

Choosing the Execution→Step... (ALT, E, S) command opens the following dialog box:

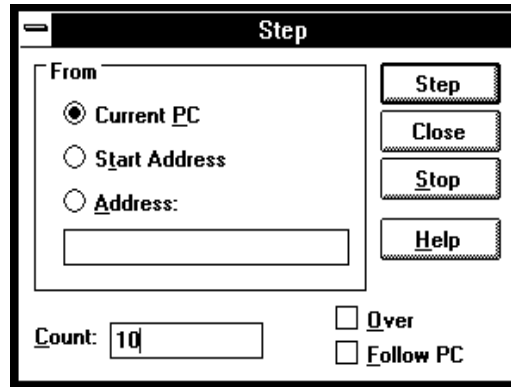

- | | |
|---------------|---|
| Current PC | Specifies that stepping start from the current program counter address. |
| Start Address | Specifies that stepping start from the start address or <i>transfer address</i> . |
| Address | Lets you enter the address from which to single-step. |
| Count | Indicates the step count. The count decrements by one for every step and stops at 0. |
| Over | If the source line to be executed contains a function call or the assembly language instruction to be executed contains a subroutine call, this option specifies that the entire function or subroutine be executed. |
| Follow PC | If you check the Follow PC box, stepping will provide more detail because it will follow the PC for each step, and update the Source window after each step. Leaving this box unchecked speeds the stepping process; the steps will be counted, but the content of the Source window will not be updated until stepping is completed. |

Step	Single-steps the specified number of instructions or source lines, starting from the specified address.
Close	Closes the dialog box.
Stop	Stops single-stepping.

Command File Command

`STE(P) count`

Single-steps the specified number of instructions or source lines, starting from the current program counter address.

`STE(P) count address`

Single-steps the specified number of instructions or source lines, starting from the specified address.

`STE(P) count STA(RT)`

Single-steps the specified number of instructions or source lines, starting from the transfer address defined in the object file.

`OVE(R) count`

Single-steps the specified number of instructions or source lines, starting from the current program counter address. If an instruction or source line makes a subroutine or function call, the entire subroutine or function is executed.

`OVE(R) count address`

Single-steps the specified number of instructions or source lines, starting from the specified address. If an instruction or source line makes a subroutine or function call, the entire subroutine or function is executed.

`OVE(R) count STA(RT)`

Single-steps the specified number of instructions or source lines, starting from the transfer address defined in the object file. If an instruction or source line makes a subroutine or function call, the entire subroutine or function is executed.

See Also

"To step multiple lines or instructions" in the "Stepping, Running, and Stopping" section of the "Debugging Programs" chapter.

Execution→Single Step (ALT, E, N)

Execution→Step Over (ALT, E, O)



Execution→Break (F4), (ALT, E, B)

Stop user program execution and break into the monitor.

This command can also be used to break into the monitor when the processor is in the EMULATION RESET status.

Once the command has been completed, the processor transfers to the RUNNING IN MONITOR status.

Command File Command

BRE (AK)

See Also

"To stop program execution" in the "Stepping, Running, and Stopping" section of the "Debugging Programs" chapter.

Execution→Reset (ALT, E, E)

Resets the emulation microprocessor.

While the processor is in the EMULATION RESET state, no display or modification is allowed for the contents of target system memory or registers. Therefore, before you can display or modify target system memory or processor registers, you must use the Execution→Break (ALT, E, B) command to break into the monitor.

Note that if the RealTime→Monitor Intrusion→Allowed (ALT, R, T, A) command is chosen, the emulation microprocessor may switch immediately from reset to running in monitor, for example, to update the contents of a register window.

Command File Command

RES (ET)

See Also

"To reset the processor" in the "Stepping, Running, and Stopping" section of the "Debugging Programs" chapter.



Breakpoint→Set at Cursor (ALT, B, S)

Sets a breakpoint at the cursor-selected address in the Source window.

The breakpoint marker "BP" appears on lines at which breakpoints are set.

When a breakpoint is hit, program execution stops immediately before executing the instruction or source code line at which the breakpoint is set.

A set breakpoint remains active until it is deleted.

Because breakpoints are set by replacing program opcodes with breakpoint instructions, they cannot be set in programs stored in target system ROM. In addition, breakpoints do not function properly when set at addresses where no opcode is found.

The TRAP instruction is used as the breakpoint instruction. The TRAP number is specified with the Settings→Emulator Config→Hardware... (ALT, S, E, H) command.

The Breakpoint→Set at Cursor (ALT, B, S) command replaces the original instruction at the specified address with a TRAP instruction. When the emulator detects the TRAP instruction, it breaks to the monitor and restores the original instruction. When the emulator detects a TRAP instruction that was not inserted as a breakpoint, the emulator breaks and transfers to the "UNDEFINED BREAKPOINT at address" status.

The Breakpoint→Set at Cursor (ALT, B, S) command may cause BP markers to appear at two or more addresses. This happens when a single instruction is associated with two or more source lines. You can select the mnemonic display mode to verify that the breakpoint is set at a single address.

Command File Command

```
BP SET address
```

See Also

"To set a breakpoint" in the "Using Breakpoints and Break Macros" section of the "Debugging Programs" chapter.

Breakpoint→Delete at Cursor (ALT, B, D)

Deletes the breakpoint set at the cursor-selected address in the Source window.

This command is only applicable to lines that contain "BP" markers (which indicate set breakpoints). Once the breakpoint is deleted, the original instruction is replaced.

Command File Command

BP DEL(ETE) address

See Also

"To delete a single breakpoint" in the "Using Breakpoints and Break Macros" section of the "Debugging Programs" chapter.

Breakpoint→Edit... (ALT, B, E)



Breakpoint→Set Macro... (ALT, B, M)

Sets a *break macro* immediately before the cursor-selected address in the Source window.

Break macro lines are marked with the "BP" breakpoint marker, and the corresponding addresses or line numbers are displayed in decimal format.

When a break macro is hit, program execution stops immediately before executing the instruction or source code line at which the break macro is set. Then, the commands associated with the break macro are executed. When a "RUN" command is set as the last command in the break macro, the system executes the break macro and resumes program execution.

The break macro remains active until it is deleted with the Breakpoint→Delete Macro (ALT, B, L) command or the Breakpoint→Edit... (ALT, B, E) command.

Because break macros use breakpoints, they cannot be set at addresses in target system ROM.

Additional commands can be added to existing break macros as follows:

- When a source code line or disassembled instruction is cursor-selected, the additional command is inserted at the top of the list of commands.
- When a macro command line is cursor-selected, the additional command is inserted immediately following the cursor-selected command.

Breakpoint Edit Dialog Box

Choosing the Breakpoint→Set Macro... (ALT, B, M) command opens the following dialog box:

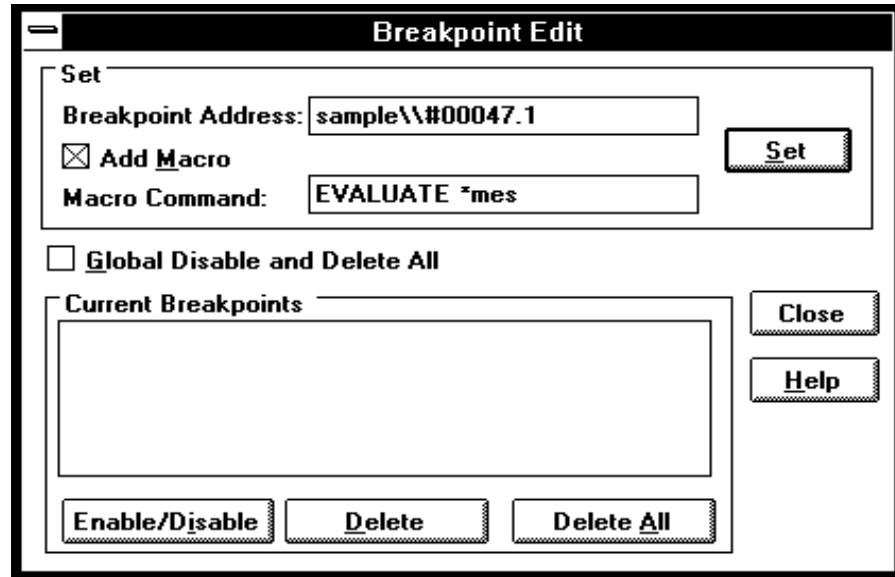

Breakpoint Address Displays the specified line number or address followed by a decimal point and the break macro line number.

Add Macro Activates the Macro Command text box.

Macro Command Specifies the command to be added to the break macro.

Set Inserts the specified macro command at the location immediately preceding the specified source line or address, or inserts the macro command at the location immediately following the specified break macro line.

Two or more commands can be associated with a break macro by entering the first command and choosing Set, then entering the second command and choosing Set, and so on. Commands execute in the order of their entry.

Chapter 8: Menu Bar Commands

Breakpoint→Set Macro... (ALT, B, M)

Global Disable and Delete All	Disables and deletes all current breakpoints and break macros.
Current Breakpoints	Displays the addresses and line numbers of the current breakpoints and break macros. Allows you to select breakpoints or break macros to be deleted.
Enable/Disable	Enable/Disable the selected breakpoint and break macro.
Delete	Deletes the selected breakpoints or break macros from the Current Breakpoints list box.
Delete All	Deletes all breakpoints and break macros from the Current Breakpoints list box.
Close	Closes the dialog box.

Command File Command

BM SET address command

See Also

"To set a break macro" in the "Using Breakpoints and Break Macros" section of the "Debugging Programs" chapter.

Breakpoint→Delete Macro (ALT, B, L)

Removes the break macro set at the cursor-indicated address in the Source window.

This command is only applicable to lines that contain "BP" markers (which indicate set breakpoints) or break macro lines.

When a source code line is cursor-selected, this command removes the breakpoint and all the macros commands set at the line.

When a break macro line is cursor-selected, this command removes the single macro command at the line.

Command File Command

BM DEL(ETE) address

See Also

"To delete a single break macro" in the "Using Breakpoints and Break Macros" section of the "Debugging Programs" chapter.

Breakpoint→Edit... (ALT, B, E)



Breakpoint→Edit... (ALT, B, E)

Lets you set, list, or delete breakpoints and break macros. Breakpoints are always globally enabled on initial entry into the RTC interface.

Breakpoint Edit Dialog Box

Choosing the Breakpoint→Edit... (ALT, B, E) command opens the following dialog box:

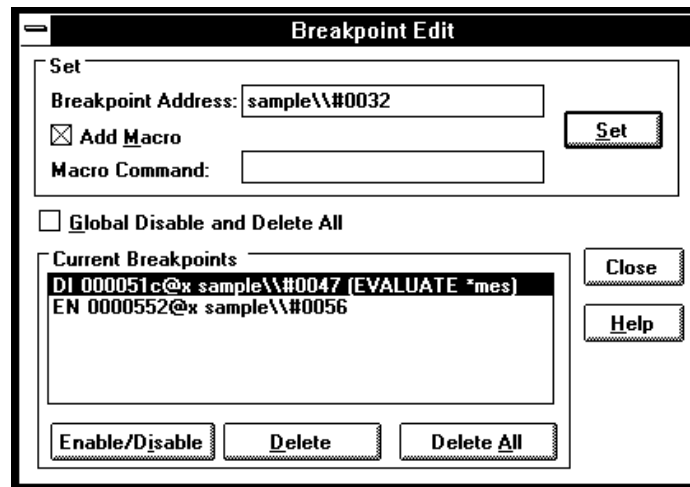

Breakpoint Address	Lets you specify the address at which to set a breakpoint or a break macro.
Add Macro	When selected, this specifies that a break macro should be included with the breakpoint.
Macro Command	Lets you specify the macro to be included with the breakpoint.
Set	Sets a breakpoint with or without a break macro at the specified address.

Global Disable and Delete All	When selected, all existing breakpoints are deleted (not simply disabled), and no new breakpoints can be added.
Current Breakpoints	Displays the addresses and line numbers of the current breakpoints and break macros. Allows you to select the breakpoints or break macros to be enabled/disabled or deleted.
Enable/Disable	Disables or enables the selected breakpoints or breakpoint macros in the Current Breakpoints list box. Enabled breakpoints begin with EN in the Current Breakpoints list and show "BP" at the start of the line in the Source window list. Disabled breakpoints begin with DI in the Current Breakpoints list and show "bp" at the start of the line in the Source window list.
Delete	Deletes the selected breakpoints or break macros from the Current Breakpoints list box.
Delete All	Deletes all the breakpoints and break macros from the Current Breakpoints list box.
Close	Closes the dialog box.

Command File Command

MOD (E) BKP (TBREAK) ON | OFF

BP DEL (ETE) ALL

BP DIS (ABLE) address

BP ENA (BLE) address

See Also

"To disable a breakpoint" and
"To list the breakpoints and break macros" in the "Using Breakpoints and Break Macros" section of the "Debugging Programs" chapter.

Variable→Edit... (ALT, V, E)

Displays or modifies the contents of the specified variable or copies it to the WatchPoint window.

A dynamic variable can be registered as a watchpoint when the current program counter is in the function in which the variable is declared. If the program counter is not in this function, the variable name is invalid and an error results.

Variable Edit Dialog Box

Choosing the Variable→Edit... (ALT, V, E) command opens the following dialog box:

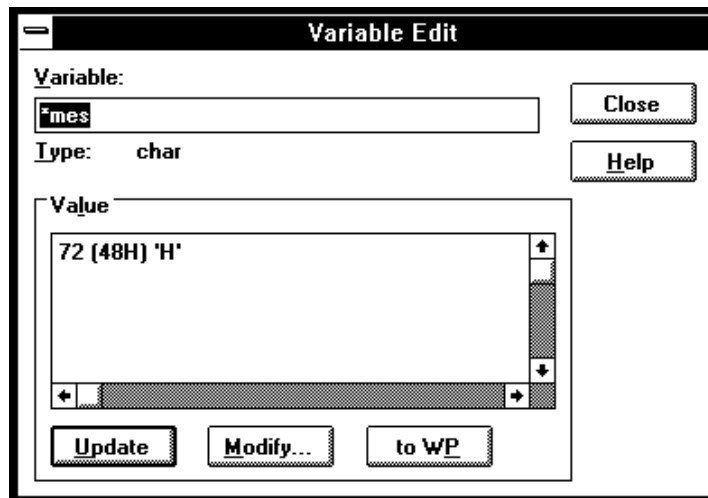

Variable	Specifies the name of the variable to be displayed or modified. The contents of the clipboard, usually a variable selected from the another window, automatically appears in this text box.
Type	Displays the type of the specified variable.
Value	Displays the contents of the specified variable.

Update	Reads and displays the contents of the variable specified in the Variable text box.
Modify	Modifies the contents of the specified variable. Choosing this button opens the Variable Modify Dialog Box, which lets you edit the contents of the variable.
to WP	Adds the specified variable to the WatchPoint window.
Close	Closes the dialog box.

Command File Command

VARI(ABLE) variable TO data

Replaces the contents of the specified variable with the specified value.

See Also

"To display a variable" and

"To monitor a variable in the WatchPoint window" in the "Displaying and Editing Variables" section of the "Debugging Programs" chapter.

"Symbols" in the "Expressions in Commands" chapter.

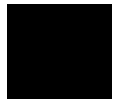

Variable Modify Dialog Box

Choosing the Modify button in the Variable Edit dialog box opens the following dialog box, where you enter the new value and choose the OK button to confirm the new value.

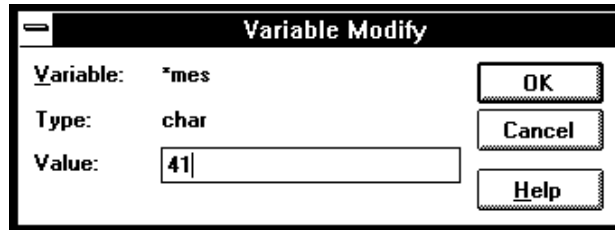

Variable	Shows the variable to be edited.
Type	Indicates the type of the variable displayed in the Variable field.
Value	Lets you enter the new value of the variable.
OK	Replaces the contents of the specified variable with the specified value and closes the dialog box.
Cancel	Cancels the command and closes the dialog box.

See Also

"To edit a variable" in the "Displaying and Editing Variables" section of the "Debugging Programs" chapter.

Trace→Function Flow (ALT, T, F)

Traces function flow by storing function entry points in the trace buffer.

The analyzer identifies function entry points by looking for the following sequence:

- 1** A program fetch of the LINK instruction.
- 2** A data write (the first word of the stack pointer push). If a non-program fetch state is captured before the data write, the sequence restarts.
- 3** A second data write (the second word of the stack pointer push). If any other state is captured, the sequence restarts.
- 4** Any program fetch. The sequence is repeated to identify the next function entry point.

Assembly language functions can also be traced provided that they comply with C function call conventions.

Note

When using the MCC68K compiler, you must specify the -Kf option when compiling programs in order for the debugger to be able to trace function flow. (The -Kf option creates frame pointers for functions.)

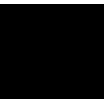

Command File Command

TRA(CE) FUN(CTION) FLO(W)

See Also

"To trace function flow" in the "Tracing Program Execution" section of the "Debugging Programs" chapter.

Trace→Function Caller... (ALT, T, C)

Traces the caller of the specified function.

The function name can be selected from another window (in other words, copied to the clipboard) before choosing the command; it will automatically appear in the dialog box that is opened.

The analyzer stores only the execution of the function entry point and prestores execution states that occur before the function entry point. These prestored states correspond to the function call statements and identify the caller of the function.

When assembly language programs are used, you can specify the assembler symbol for a subroutine instead of a C function name, and the prestored states will show the instructions that called the subroutine.

Note

Because of prefetching by the 6830x processor, the analyzer may fail in tracing the caller.

Function Caller Trace Dialog Box

Choosing the Trace→Function Caller... (ALT, T, C) command opens the following dialog box:

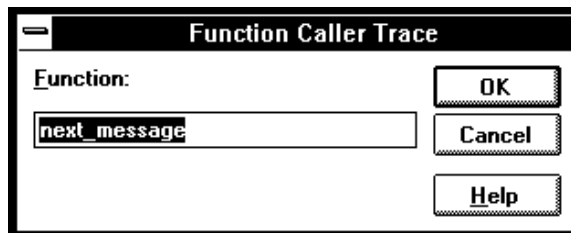

- | | |
|----------|--|
| Function | Lets you enter the function whose callers you want to trace. |
| OK | Executes the command and closes the dialog box. |
| Cancel | Cancels the command and closes the dialog box. |

Command File Command

TRA(CE) FUNC(TION) CAL(L) address

See Also

"To trace callers of a specified function" in the "Tracing Program Execution" section of the "Debugging Programs" chapter.



Trace→Function Statement... (ALT, T, S)

Traces execution within the specified function.

The function name can be selected from another window (in other words, copied to the clipboard) before choosing the command; it will automatically appear in the dialog box that is opened.

The analyzer stores execution states in the function's address range.

Because the analyzer is set up based on function information from the object file, this command cannot be used to trace non-C functions.

Note

The analyzer traces unexecuted instructions due to prefetching by 6830x processor.

Function Statement Trace Dialog Box

Choosing the Trace→Function Statement... (ALT, T, S) command opens the following dialog box:

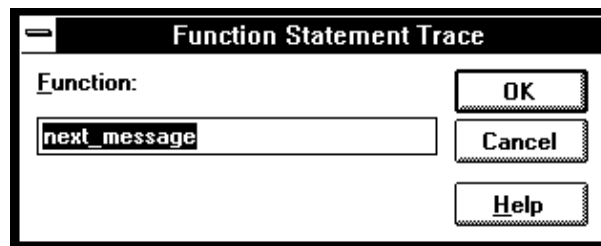

Function	Lets you enter the function whose execution you want to trace.
OK	Traces within the specified function and closes the dialog box.
Cancel	Cancels the command and closes the dialog box.

Command File Command

TRA(CE) FUNC(TION) STA(TEMENT) address

See Also

"To trace execution within a specified function" in the "Tracing Program Execution" section of the "Debugging Programs" chapter.



Trace→Variable Access... (ALT, T, V)

Traces accesses to the specified variable.

The variable name can be selected from another window (in other words, copied to the clipboard) before choosing the command; it will automatically appear in the dialog box that is opened.

You can specify any of the external or static variables, or the variables having a fixed address throughout the course of program execution.

The analyzer stores only accesses within the range of the variable and prestores execution states that occur before the access. These prestored states correspond to the statements that access the variable.

Variable Access Dialog Box

Choosing the Trace→Variable Access... (ALT, T, V) command opens the following dialog box:

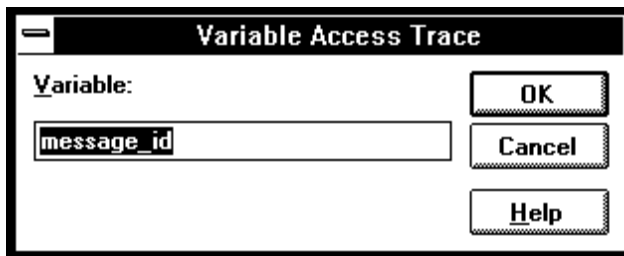

- | | |
|----------|--|
| Variable | Lets you enter the variable name. |
| OK | Traces accesses to the specified variable and closes the dialog box. |
| Cancel | Cancels the command and closes the dialog box. |

Command File Command

```
TRA(CE) VAR(IABLE) ACC(ESS) address
```

See Also

"To trace accesses to a specified variable" in the "Tracing Program Execution" section of the "Debugging Programs" chapter.



Trace→Variable Break... (ALT, T, B)

Traces before, and breaks program execution when, a value is written to a variable.

The variable name can be selected from another window (in other words, copied to the clipboard) before choosing the command; it will automatically appear in the dialog box that is opened.

You can specify any of the external or static variables, or the variables having a fixed address throughout the course of program execution.

Variable Break Dialog Box

Choosing the Trace→Variable Break... (ALT, T, B) command opens the following dialog box:

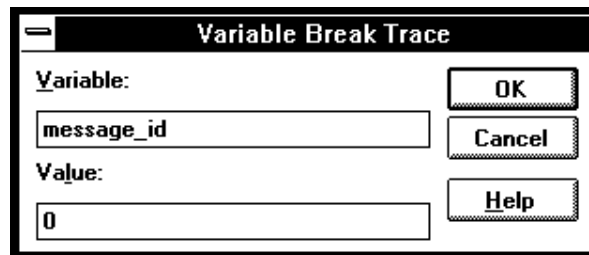

Variable	Lets you enter the variable name.
Value	Lets you enter the value that, when written to the variable, triggers the analyzer.
OK	Starts the trace and closes the dialog box.
Cancel	Cancels the command and closes the dialog box.

Command File Command

```
TRA(CE) VAR(IABLE) BRE(AK) address data
```

See Also

"To trace before a particular variable value and break" in the "Tracing Program Execution" section of the "Debugging Programs" chapter.



Trace→Edit... (ALT, T, E)

Edits the trace specification of the last trace command.

This command is useful for making modifications to the last entered trace command, even if the analyzer was setup automatically as with the Trace→Function or Trace→Variable commands.

Trace specifications are edited with Sequence Trace Setting dialog box.

Command File Command

TRA(CE) SAV(E) filename

Stores the current trace specification to a file.

TRA(CE) LOA(D) filename

Loads the specified trace setting file.

TRA(CE) CUS(TOMIZE)

Traces program execution using the loaded trace setting file.

See Also

"To edit a trace specification" in the "Setting Up Custom Trace Specifications" section of the "Debugging Programs" chapter.

Trace→Sequence... (ALT, T, Q)

Trace→Trigger Store... (ALT, T, T)

Traces program execution as specified in the Trigger Store Trace dialog box.

You can enter address, data, and status values that qualify the state(s) that, when captured by the analyzer, will be stored in the trace buffer or will trigger the analyzer.

Data values are 16-bit values (because the data bus is 16 bits wide). To identify byte values on the data bus, use "don't cares" as shown below:

Data at an even address: 12xx

Data at an odd address: 0xx34

Status values identify the types of microprocessor bus cycles. You may select status values from a predefined list.

Note

The analyzer traces unexecuted instructions due to prefetching by the 6830x processor.

Trigger Store Trace Dialog Box

Choosing the Trace→Trigger Store... (ALT, T, T) command opens the following dialog box:

The dialog box is titled "Trigger Store Trace". It contains two main sections: "Trigger" and "Store".

Trigger Section:

- Checkbox: NOT
- Input fields: Address, Data, Status (with a dropdown arrow)
- Input field: End Address
- Radio buttons: trigger start, trigger center, trigger end

Store Section:

- Checkbox: NOT
- Input fields: Address, Data, Status (with a dropdown arrow)
- Input field: End Address

Buttons (Right Side): OK, Cancel, Clear, Load..., Save..., Help

Chapter 8: Menu Bar Commands
Trace→Trigger Store... (ALT, T, T)

Trigger	This box groups the items that make up the trigger condition.
NOT	Specifies any state that does not match the Address, Data, and Status values.
Address	Specifies the address portion of the state qualifier.
End Address	Specifies the end address of an address range.
Data	Specifies the data portion of the state qualifier.
Status	Specifies the status portion of the state qualifier.
trigger start	Specifies that states captured after the trigger condition be stored in the trace buffer.
trigger center	Specifies that states captured before and after the trigger condition be stored in the trace buffer.
trigger end	Specifies that states captured before the trigger condition be stored in the trace buffer.
Store	This box groups the items that make up the store condition.
OK	Starts the specified trace and closes the dialog box.
Cancel	Cancels the trace setting and closes the dialog box.
Clear	Restores the dialog box to its default state.
Load...	Opens a file selection dialog box from which you select the name of a trace specification file previously saved from the Trigger Store Trace dialog box. Trace specification files have the extension ".TRC".
Save...	Opens a file selection dialog box from which you select the name of the trace specification file.

Command File Command

TRA(CE) LOA(D) filename
Loads the specified trace setting file.

TRA(CE) CUS(TOMIZE)
Traces program execution using the loaded trace setting file.

See Also

"To set up a 'Trigger Store' trace specification" in the "Setting Up Custom Trace Specifications" section of the "Debugging Programs" chapter.



Trace→Find Then Trigger... (ALT, T, D)

Traces program execution as specified in the Find Then Trigger Trace dialog box.

This command lets you set up a two level sequential trace specification that works like this:

- 1** Once the trace starts, the analyzer stores (in the trace buffer) the states that satisfy the Enable Store condition while searching for a state that satisfies the Enable condition.
- 2** After the Enable condition has been found, the analyzer stores the states that satisfy the Trigger Store condition while searching for a state that satisfies the Trigger condition.
- 3** After the Trigger condition has been found, the analyzer stores the states that satisfy the Store condition.

If any state during the sequence satisfies the Restart condition, the sequence starts over.

You can enter address, data, and status values that qualify state(s) by setting up pattern or range resources. These patterns and range resources are used when defining the various conditions.

A trace is complete when the trace buffer is full.

Note

The analyzer traces unexecuted instructions due to prefetching by the 6830x processor.

Find Then Trigger Trace Dialog Box

Choosing the Trace→Find Then Trigger... (ALT, T, D) command opens the following dialog box:

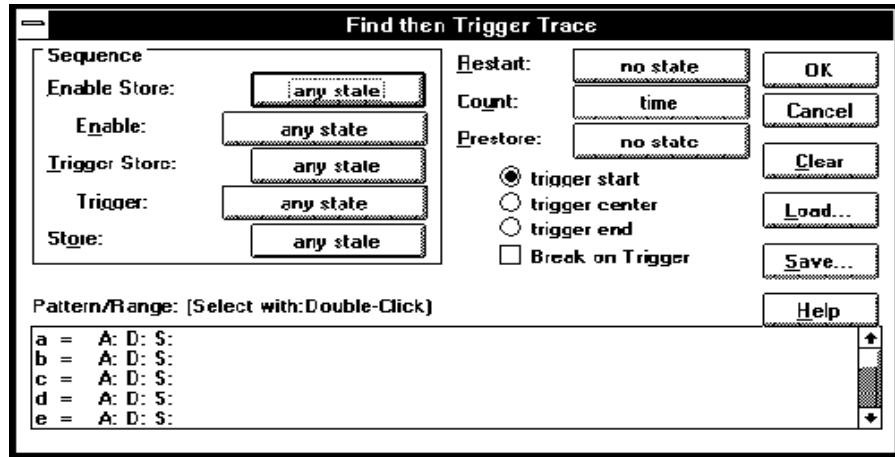

The Sequence group box specifies a two term sequential trigger condition. It also lets you specify store conditions during the sequence.

Enable Store	Qualifies the states that get stored (in the trace buffer) while searching for a state that satisfies the enable condition.
Enable	Specifies the condition that causes a transfer to the next sequence level.
Trigger Store	Qualifies the states that get stored while the analyzer searches for the trigger condition.
Trigger	Specifies the trigger condition.
Store	Qualifies the states that get stored after the trigger condition is found.
Restart	Specifies the condition that restarts the sequence.

Count	Specifies whether time or the occurrences of a particular state are counted; you can also turn counts OFF. See the Condition Dialog Boxes.
Prestore	Qualifies the states that may be stored before each normally stored state. Up to two states may be prestored for each normally stored state. Prestored states can be used to show from where a function is called or a variable is accessed.
trigger start	The state that satisfies trigger condition is positioned at the start of the trace, and states that satisfy the Store condition will be stored after the trigger. In this case, the states that satisfy the Enable Store and Trigger Store conditions will not appear in the trace.
trigger center	The state that satisfies the trigger condition is positioned in the center of the trace, and states that satisfy the store conditions will be stored before and after the trigger.
trigger end	The state that satisfies the trigger condition is positioned at the end of the trace, and states that satisfy the Enable Store and Trigger Store conditions will be stored before the trigger. In this case, states that satisfy the Store condition will not appear in the trace.
Break on Trigger	When selected, this option specifies that execution break into the monitor when the analyzer is triggered.
Pattern/Range	Specifies the trace patterns for the state conditions. Double-clicking the desired pattern or range in the Pattern/Range list box opens the Trace Pattern Dialog Box or the Trace Range Dialog Box, where you specify the desired trace pattern or range. Clicking the Sequence, Restart, Count, or Prestore buttons causes the Condition Dialog Boxes to be opened. This dialog box lets you select or combine patterns or ranges to specify the condition.

OK	Starts the specified trace and closes the dialog box.
Cancel	Cancels trace setting and closes the dialog box.
Clear	Restores the dialog box to its default state.
Load...	Opens a file selection dialog box from which you select the name of a trace specification file previously saved from the Trigger Store Trace or Find Then Trigger Trace dialog boxes. Trace specification files have the extension ".TRC".
Save...	Opens a file selection dialog box in which you specify a name to identify a file containing the present trace specification.

Command File Command

TRA(CE) LOA(D) filename
Loads the specified trace setting file.

TRA(CE) CUS(TOMIZE)
Traces program execution using the loaded trace setting file.

See Also

"To set up a 'Find Then Trigger' trace specification" in the "Setting Up Custom Trace Specifications" section of the "Debugging Programs" chapter.

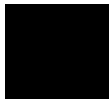

Trace→Sequence... (ALT, T, Q)

Traces program execution as specified in the Sequence Trace dialog box.

This command lets you set up a multilevel sequential trace specification that works like this:

- 1** Once the trace starts, the analyzer stays on sequence level 1 until the primary or secondary branch condition is found. (If a state satisfies both primary and secondary branch conditions, the primary branch is taken.) Once the primary or secondary branch condition is found, the analyzer transfers to the sequence level specified by the "to" button.
- 2** The analyzer stays at the next sequence level until its primary or secondary branch condition is met; then, the analyzer transfers to the sequence level specified by the "to" button.
- 3** When the analyzer reaches the sequence level specified in Trigger On, the analyzer is triggered.
- 4** During the above described operation, the analyzer stores the states specified in the Store text box.

The trace is complete when the trace buffer is full.

Note

The analyzer traces unexecuted instructions due to prefetching by the 6830x processor.

Sequence Trace Dialog Box

Choosing the Trace→Sequence... (ALT, T, Q) command opens the following dialog box:

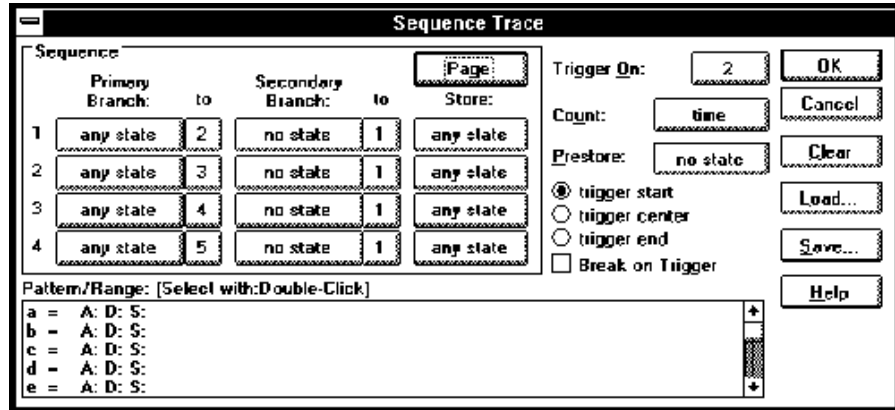

The Sequence group box specifies primary and secondary branch conditions for transferring from one sequence level to another. It also specifies store conditions for each of the eight sequence levels.

Primary Branch Specifies the condition for transferring to the sequence level specified in the "to" text box.

Secondary Branch Specifies the condition for transferring to the sequence level specified in the "to" text box. Secondary branches are used to do things like restart the sequence if a particular state is found.

Store Specifies the states to be stored in the trace buffer at each sequence level.

Page Toggles the display between sequence levels 1 through 4 and levels 5 through 8.

Trigger On Specifies the sequence level whose entry triggers the analyzer. See the Sequence Number Dialog Box.

Count	Specifies whether time or the occurrences of a particular state are counted; you can also turn counts OFF. See the Condition Dialog Boxes.
Prestore	Qualifies the states that may be stored before each normally stored state. Up to two states may be prestored for each normally stored state. Prestored states can be used to show from where a function is called or a variable is accessed.
trigger start	The state that satisfies trigger condition is positioned at the start of the trace, and states that satisfy the store conditions will be stored after the trigger.
trigger center	The state that satisfies the trigger condition is positioned in the center of the trace, and states that satisfy the store conditions will be stored before and after the trigger.
trigger end	The state that satisfies the trigger condition is positioned at the end of the trace, and states that satisfy the store conditions will be stored before the trigger.
Break on Trigger	When selected, this option specifies that execution break into the monitor when the analyzer is triggered.
Pattern/Range	Specifies the trace patterns for the state conditions. Double-clicking the desired pattern or range in the Pattern/Range list box opens the Trace Pattern Dialog Box or the Trace Range Dialog Box, where you specify the desired trace pattern or range. Clicking the Primary Branch, Secondary Branch, Store, Count, or Prestore buttons causes the Condition Dialog Boxes to be opened. This dialog box lets you select or combine patterns or ranges to specify the condition.
OK	Starts the specified trace and closes the dialog box.
Cancel	Cancels trace setting and closes the dialog box.

Clear	Restores the dialog box to its default state.
Load...	Opens a file selection dialog box from which you select the name of a trace specification file previously saved from any of the trace setting dialog boxes. Trace specification files have the extension ".TRC".
Save...	Opens a file selection dialog box from which you select the name of the trace specification file.

Command File Command

TRA(CE) LOA(D) filename
Loads the specified trace setting file.

TRA(CE) CUS(TOMIZE)
Traces program execution using the loaded trace setting file.

See Also

"To set up a 'Sequence' trace specification" in the "Setting Up Custom Trace Specifications" section of the "Debugging Programs" chapter.

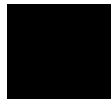

Trace→Until Halt (ALT, T, U)

Traces program execution until the Trace→Halt (ALT, T, H) command is chosen.

This command is useful in tracing execution that leads to a processor halt or a break to the background monitor. Before executing the program, choose the Trace→Until Halt (ALT, T, U) command. Then, run the program. After the processor has halted or broken into the background monitor, choose the Trace→Halt (ALT, T, H) command to stop the trace. The execution that led up to the break or halt will be displayed.

Command File Command

TRA(CE) ALW(AYS)

See Also

"To trace until the command is halted" in the "Tracing Program Execution" section of the "Debugging Programs" chapter.

Trace→Halt (ALT, T, H)

Stops a running trace.

This command stops a currently running trace whether the trace was started with the Trace→Until Halt (ALT, T, U) command or another trace command.

As soon as the analyzer stops the trace, stored states are displayed in the Trace window.

Command File Command

TRA(CE) STO(P)

See Also

"To stop a running trace" in the "Tracing Program Execution" section of the "Debugging Programs" chapter.



Trace→Again (F7), (ALT, T, A)

Traces program execution using the last trace specification stored in the HP 64700.

If you haven't entered a trace command since you started the debugger, the last trace specification stored in the HP 64700 may be a trace specification set up by a different user; in this case, you cannot view or edit the trace specification.

Command File Command

TRA (CE) AGA (IN)

See Also

"To repeat the last trace" in the "Tracing Program Execution" section of the "Debugging Programs" chapter.

Condition Dialog Boxes

Choosing the buttons associated with enable, trigger, primary branch, secondary branch, store, or prestore conditions opens the following dialog box:

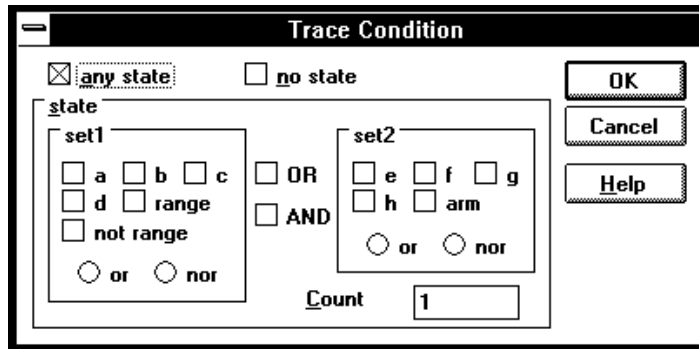

Choosing the button associated with the count condition opens the following dialog box:

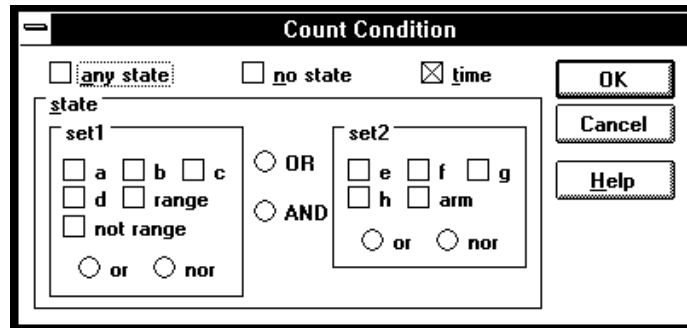

- no state No state meets the specified condition.
- any state Any state meets the specified condition.
- time The analyzer counts time for each state stored in the trace.

Chapter 8: Menu Bar Commands
Condition Dialog Boxes

state	This group box lets you qualify the state that will meet the specified condition. You can qualify the state as one of the patterns "a" through "h", the "range", or the "arm", or you can qualify the state as a combination of the patterns, range, or arm by using the interset or intraset operators.
a b c d e f g h	<p>The patterns that qualify states by identifying the address, data, and/or status values.</p> <p>The values for a pattern are specified by selecting one of the patterns in the Pattern/Range list box and entering values in the Trace Pattern Dialog Box.</p>
range	<p>Identifies a range of address or data values.</p> <p>The values for a range are specified by selecting the range in the Pattern/Range list box and entering values in the Trace Range Dialog Box.</p>
not range	Identifies all values not in the specified range.
arm	Identifies the condition that arms (in other words, activates) the analyzer. The analyzer can be armed by an input signal on the BNC port.
or/nor	<p>You can combine patterns within the set1 or set2 group boxes with these logical operators.</p> <p>You can create the AND and NAND operators by selecting NOT when defining patterns and applying DeMorgan's law (the / character is used to represent a logical NOT):</p> <p>AND A and B = /(/A or /B) NOR NAND /(A and B) = /A or /B OR</p>
OR/AND	You can combine patterns from the set1 and set2 group boxes with these logical operators.

Count	Appearing in Trace Condition dialog boxes, this value specifies the number of occurrences of the state that will satisfy the condition.
OK	Applies the state qualifier to the specified condition and closes the dialog box.
Cancel	Closes the dialog box.

See Also

"To set up a 'Find Then Trigger' trace specification" and
"To set up a 'Sequence' trace specification" in the "Setting Up Custom Trace Specifications" section of the "Debugging Programs" chapter.

Trace→Find Then Trigger... (ALT, T, D)

Trace→Sequence... (ALT, T, Q)



Trace Pattern Dialog Box

Selecting one of the patterns in the Pattern/Range list box opens the following dialog box:

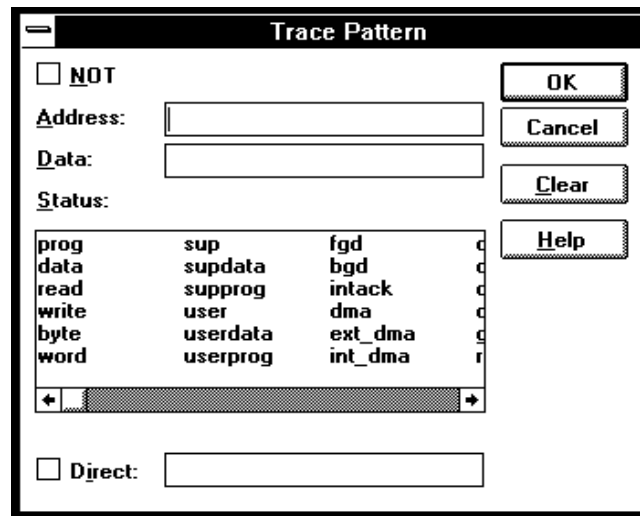

- | | |
|---------|---|
| NOT | Lets you specify all values other than the address, data, and/or status values specified. |
| Address | Lets you enter the address value for the pattern. |
| Data | Lets you enter the data value for the pattern. |
| Status | Lets you select the <i>status value</i> for the pattern. |
| Direct | Lets you enter a status value other than one of the predefined status values. |
| Clear | Clears the values specified for the pattern. |
| OK | Applies the values specified for the pattern, and closes the dialog box. |

Cancel Closes the dialog box.

See Also

"To set up a 'Find Then Trigger' trace specification" and
"To set up a 'Sequence' trace specification" in the "Setting Up Custom Trace
Specifications" section of the "Debugging Programs" chapter.

Trace→Find Then Trigger... (ALT, T, D)

Trace→Sequence... (ALT, T, Q)



Trace Range Dialog Box

Selecting the range at the bottom of the Pattern/Range list box opens the following dialog box:

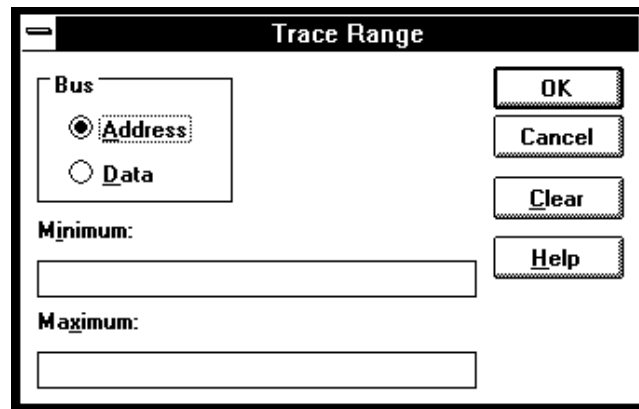

Address	Selects a range of address values.
Data	Selects a range of data values.
Minimum	Lets you enter the minimum value for the range.
Maximum	Lets you enter the maximum value for the range.
OK	Applies the values specified for the range, and closes the dialog box.
Cancel	Closes the dialog box.
Clear	Clears the values specified for the range.

See Also

"To set up a 'Find Then Trigger' trace specification" and
"To set up a 'Sequence' trace specification" in the "Setting Up Custom Trace Specifications" section of the "Debugging Programs" chapter.

Trace→Find Then Trigger... (ALT, T, D)
Trace→Sequence... (ALT, T, Q)



Sequence Number Dialog Box

Choosing the buttons associated with "to" or Trigger On opens the following dialog box:

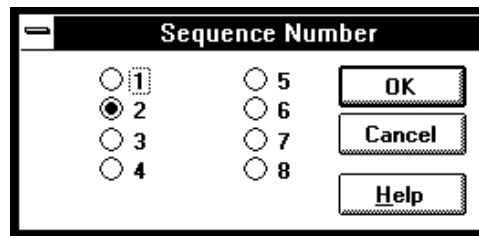

1-8 These options specify the sequence level.

OK Applies the selected sequence level and closes the dialog box.

Cancel Closes the dialog box.

See Also

"To set up a 'Sequence' trace specification" in the "Setting Up Custom Trace Specifications" section of the "Debugging Programs" chapter.

Trace→Sequence... (ALT, T, Q)

RealTime→Monitor Intrusion→Disallowed (ALT, R, T, D)

Activates the real-time mode.

When the user program is running in real-time mode, no command that would normally cause temporary suspension of program execution is allowed. Also, the system hides:

- The Register window.
- Target system memory in the Memory window.
- Target system I/O locations in the I/O window.
- Target system memory variables in the WatchPoint window.
- Target system memory in the Source window.

While the processor is in the RUNNING REALTIME IN USER PROGRAM state, no display or modification is allowed for the contents of target system memory or registers. Therefore, before you can display or modify target system memory or processor registers, you must use the Execution→Break (ALT, E, B) command to stop user program execution and break into the monitor.

Command File Command

```
MOD(E) REA(LTIME) ON
```

See Also

"To allow or deny monitor intrusion" in the "Setting the Real-Time Options" section of the "Configuring the Emulator" chapter.

RealTime→Monitor Intrusion→Allowed (ALT, R, T, A)

Deactivates the real-time mode.

Commands that cause temporary breaks to the monitor during program execution are allowed.

Command File Command

```
MOD(E) REA(LTIME) OFF
```

See Also

"To allow or deny monitor intrusion" in the "Setting the Real-Time Options" section of the "Configuring the Emulator" chapter.

RealTime→I/O Polling→ON (ALT, R, I, O)

Enables access to I/O.

Command File Command

```
MOD(E) IOG(UARD) OFF
```

See Also

"To turn polling ON or OFF" in the "Setting the Real-Time Options" section of the "Configuring the Emulator" chapter.



RealTime→I/O Polling→OFF (ALT, R, I, F)

Disables access to I/O.

When polling is turned OFF, values in the I/O window are updated on entry to the monitor. When monitor intrusion is not allowed during program execution, the I/O window is not updated and contents are replaced by dashes (-).

Command File Command

```
MOD(E) IOG(UARD) ON
```

See Also

"To turn polling ON or OFF" in the "Setting the Real-Time Options" section of the "Configuring the Emulator" chapter.

RealTime→Watchpoint Polling→ON (ALT, R, W, O)

Turns ON polling to update values displayed in the WatchPoint window.

When polling is turned ON, temporary breaks in program execution occur when the WatchPoint window is updated.

Command File Command

```
MOD(E) WAT(CHPOLL) ON
```

See Also

"To turn polling ON or OFF" in the "Setting the Real-Time Options" section of the "Configuring the Emulator" chapter.



RealTime→Watchpoint Polling→OFF (ALT, R, W, F)

Turns OFF polling to update values displayed in the WatchPoint window.

When polling is turned OFF, values in the WatchPoint window are updated on entry to the monitor. When monitor intrusion is not allowed during program execution, the WatchPoint window is not updated and contents are replaced by dashes (-).

Command File Command

```
MOD(E) WAT(CHPOLL) OFF
```

See Also

"To turn polling ON or OFF" in the "Setting the Real-Time Options" section of the "Configuring the Emulator" chapter.

RealTime→Memory Polling→ON (ALT, R, M, O)

Turns ON polling to update target memory values displayed in the Memory window.

When polling is turned ON, temporary breaks in program execution occur when target system memory locations in the Memory window are updated. When monitor intrusion is not allowed during program execution, the contents of target memory locations are replaced by dashes (-).

Also, when polling is turned ON, you can modify the addresses displayed or contents of memory locations by double-clicking on the address or value, using the keyboard to type in the new address or value, and pressing the Enter key.

Command File Command

```
MOD(E) MEM(ORYPOLL) ON
```

See Also

"To turn polling ON or OFF" in the "Setting the Real-Time Options" section of the "Configuring the Emulator" chapter.



RealTime→Memory Polling→OFF (ALT, R, M, F)

Turns OFF polling to update target memory values displayed in the Memory window.

When polling is turned OFF, values in the Memory window are updated on entry to the monitor.

Also, when polling is turned OFF, you cannot modify the addresses displayed or contents of memory locations by double-clicking on the address or value.

Command File Command

```
MOD(E) MEM(ORYPOLL) OFF
```

See Also

"To turn polling ON or OFF" in the "Setting the Real-Time Options" section of the "Configuring the Emulator" chapter.

Assemble... (ALT, A)

In-line assembler.

This command lets you modify programs by specifying assembly language instructions which are assembled and loaded into program memory.

Assembler Dialog Box

Choosing the Assemble... (ALT, A) command opens the following dialog box:

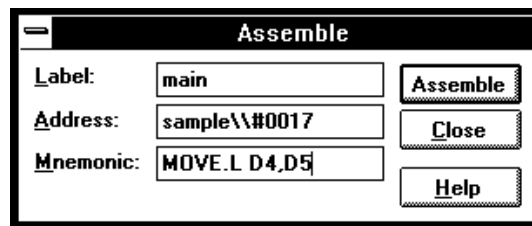

Label	Lets you assign a user-defined symbol to the specified address.
Address	Lets you enter the address at which the assembly language instruction will be loaded.
Mnemonic	Lets you enter the assembly language instruction to be assembled.
Assemble	Assembles the instruction in the Mnemonic text box, and loads it into memory at the specified address.
Close	Closes the dialog box.

Command File Command

```
ASM address label "inst_string"
```

Settings→Emulator Config→Hardware... (ALT, S, E, H)

Specifies the emulator configuration.

Hardware Config Dialog Box

Choosing the Settings→Emulator Config→Hardware... (ALT, S, E, H) command opens the following dialog box:

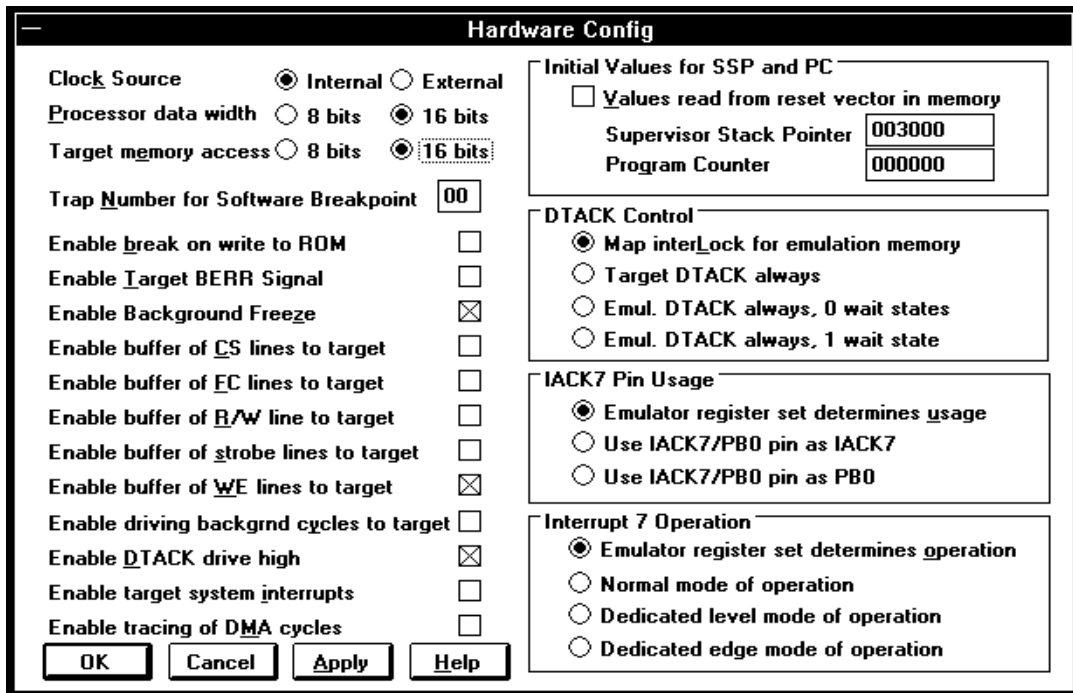

Clock Source Specifies the Internal or an External clock as the emulation microprocessor clock source.

Processor data width Specifies the size of the processor data bus when the demo board is attached. When connected to the target system, this selection is ignored and the target system BUSW pin determines target bus width.

Target memory access	Specifies the size used to access target system memory.
Trap Number for Software Breakpoint	Specifies the breakpoint trap instruction number.
Enable break on Write to ROM	Enables or disables breaks to the monitor when the user program writes to memory mapped as ROM.
Enable Target BERR Signal	Enables or disables /BERR input from the target system.
Enable Background Freeze	Asserts the processor /FRZ line when the emulator is executing the background monitor program. This freezes the activity of selected peripherals.
Enable buffer of CS lines to target	Enables or disables buffering of the chip-select lines to the target system.
Enable buffer of FC lines to target	Enables or disables buffering of the function-code lines to the target system.
Enable buffer of R/W line to target	Enables or disables buffering of the read/write line to the target system.
Enable buffer of strobe lines to target	Enables or disables buffering of the address strobe, data strobe, and /IACK7 strobe lines to the target system.
Enable buffer of WE lines to target	Enables or disables buffering of the write-enable lines to the target system.
Enable driving backgrnd cycles to target	Enables or disables driving the background monitor cycles (chip selects, address, data, and /IACK7 strobes) to the target system during execution of the background monitor.

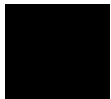

Chapter 8: Menu Bar Commands

Settings→Emulator Config→Hardware... (ALT, S, E, H)

Enable DTACK drive high	Enables or disables driving the /DTACK signal high (to deassert it) after each assertion. This only affects /DTACK supplied by the emulator.
Enable target system interrupts	Enables and disables interrupts from the target system.
Enable tracing of DMA cycles	Enables or disables storage of DMA cycles with other trace data in the analyzer trace memory.
Initial Values for SSP and PC	Specifies the source for the values to be loaded into the Supervisor Stack Pointer and Program Counter. Normally, these values are obtained from the reset vector at offsets 0 and 4 (for SSP and PC, respectively).
Values read from reset vector in memory	This selection (default) causes the emulation microprocessor to initialize its SSP and PC with values obtained from the reset vector.
Supervisor Stack Pointer	When the monitor program is entered immediately after a processor reset, the Supervisor Stack Pointer is initialized with the value you enter in this field, which is typically the same as the value at reset vector offset 0.
Program Counter	When the monitor program is entered immediately after a processor reset, the Program Counter is initialized with the value you enter in this field, which is typically the same as the value at reset vector offset 4.
DTACK Control	Specifies the source of the /DTACK signal during runs in emulation.
Map interlock for Emulation memory	This selection (default) causes the emulator to refer to the memory map and use the /DTACK specifications defined there for each address range.

Target DTACK always	Causes the emulator to ignore the /DTACK specifications in the memory map and use the /DTACK signal from the target system for all activity. Choose "Enable driving backgrnd cycles to target" if you are going to use the monitor because the target system sends no /DTACK signal during monitor execution.
Emul. DTACK always, 0 wait states	Causes the emulator to ignore the /DTACK specifications in the memory map, and use the /DTACK signal from the emulator for all activity. Choose 0 wait states for fastest system performance.
Emul. DTACK always, 1 wait state	Causes the emulator to ignore the /DTACK specifications in the memory map, and use the /DTACK signal from the emulator for all activity. Choose 1 wait state to slow the system if you are having trouble with target system startup.
IACK7 Pin Usage	Tells the emulator how the target system uses the /IACK7/PB0 pin. If the pin is /IACK7, the emulator will block it when executing the monitor program if you choose not to "Enable driving backgrnd cycles to target" in this Hardware Config dialog box. If the pin is PB0, it is never blocked.
Emulator register set determines usage	The Port B Control Register PBCNT in the emulation microprocessor determines the use of the /IACK7/PB0 pin. The emulator will read bit 0 of the PBCNT register to determine whether or not to block this pin when executing the monitor program.
Use IACK7/PB0 pin as IACK7	Tells the emulator that the pin is used as /IACK7. When the emulator is executing the monitor program, it may block this pin.
Use IACK7/PB0 as PB0	Tells the emulator that the pin is used as PB0. The emulator will not block the signal on this pin during any execution.

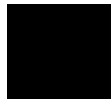

Interrupt 7 Operation	Tells the emulator how the target system receives and processes interrupts. This way, the emulator can process interrupts correctly.
Emulator register set determines operation	The emulator will use the value in the Global Interrupt Mode Register GIMR in the emulation microprocessor to process interrupts.
Normal mode of operation	The emulator will use the values of /IPL2 - /IPL0 to determine the interrupt level and to process it.
Dedicated level mode of operation	The emulator will detect /IRQ7, /IRQ6, and /IRQ1 to recognize interrupt requests and process them. The three lines are programmed to be level sensitive.
Dedicated edge mode of operation	The emulator will detect /IRQ7, /IRQ6, and /IRQ1 to recognize interrupt requests and process them. The three lines are programmed to be edge sensitive.
OK	Stores the current modification and closes the dialog box.
Cancel	Cancels the current modification and closes the dialog box.
Apply	Loads the configuration settings into the emulator.

Command File Command

CON(FIG) CLO(CK) INT(ERNAL)
Selects the internal clock.

CON(FIG) CLO(CK) EXT(ERNAL)
Selects the external clock.

CON(FIG) DAT(ABUS) 8
Specifies an 8-bit wide data bus.

CON(FIG) DAT(ABUS) 16
Specifies a 16-bit wide data bus.

CON(FIG) MEM(ACCESS) 8

Specifies that target memory is accessed in 8-bit byte-sized locations.

CON(FIG) MEM(ACCESS) 16

Specifies that target memory is accessed in 16-bit word-sized locations.

CON(FIG) SWT(RAP) value

Specifies the breakpoint trap instruction number.

CON(FIG) BRK(WROM) ENA(BLE)

Enables breaks to the monitor when writes to ROM occur.

CON(FIG) BRK(WROM) DIS(ABLE)

Disables breaks to the monitor when writes to ROM occur.

CON(FIG) BER(R) ENA(BLE)

Enables /BERR input from the target system.

CON(FIG) BER(R) DIS(ABLE)

Disables /BERR input from the target system.

CON(FIG) BKG(FRZ) EN(ABLE)

Enables assertion of the processor /FRZ line when the emulator is executing in the background monitor.

CON(FIG) BKG(FRZ) DIS(ABLE)

Disables assertion of the processor /FRZ line when the emulator is executing in the background monitor.

CON(FIG) CSB(UF) ENA(BLE)

Enables buffering of the chip-select lines to the target system.

CON(FIG) CSB(UF) DIS(ABLE)

Disables buffering of the chip-select lines to the target system.

CON(FIG) FCB(UF) ENA(BLE)

Enables buffering of the function-code lines to the target system.

CON(FIG) FCB(UF) DIS(ABLE)

Disables buffering of the function-code lines to the target system.

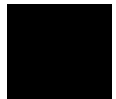

Chapter 8: Menu Bar Commands

Settings→Emulator Config→Hardware... (ALT, S, E, H)

CON(FIG) RWB(UF) ENA(BLE)

Enables buffering of the read/write line to the target system.

CON(FIG) RWB(UF) DIS(ABLE)

Disables buffering of the read/write line to the target system.

CON(FIG) STR(BSBUF) ENA(BLE)

Enables buffering of the strobe lines (address, data, and /IACK7) to the target system.

CON(FIG) STR(BSBUF) DIS(ABLE)

Disables buffering of the strobe lines (address, data, and /IACK7) to the target system.

CON(FIG) WEB(UF) ENA(BLE)

Enables buffering of the write-enable lines to the target system.

CON(FIG) WEB(UF) DIS(ABLE)

Disables buffering of the write-enable lines to the target system.

CON(FIG) DBC ENA(BLE)

Enables Driving Background Cycles (during monitor execution) to the target system.

CON(FIG) DBC DIS(ABLE)

Disables Driving Background Cycles (during monitor execution) to the target system.

CON(FIG) DRV(DTACK) ENA(BLE)

Enables driving /DTACK high (to deassert it) after each emulator-supplied /DTACK.

CON(FIG) DRV(DTAC) DIS(ABLE)

Disables driving /DTACK high (to deassert it) after each emulator-supplied /DTACK.

CON(FIG) TAR(GETINT) ENA(BLE)

Enables interrupts from the target system.

CON(FIG) TAR(GETINT) DIS(ABLE)

Disables interrupts from the target system.

CON(FIG) TRC(DMA) ENA(BLE)
Enables analyzer traces of internal DMA cycles.

CON(FIG) TRC(DMA) DIS(ABLE)
Disables analyzer traces of internal DMA cycles.

CON(FIG) VAL(SINIT) RES(ETVECTOR)
Specifies initialization of SSP and PC with values obtained from the reset vector.

CON(FIG) VAL(SINIT) USE(RSUPPLIED)
Specifies initialization of SSP and PC with values specified by CON(FIG) INI(TSSP) and INI(TPC).

CON(FIG) SSP(INIT) value
Specifies the initial value for the SSP in the emulation processor.

CON(FIG) PCI(NIT) value
Specifies the initial value for the PC in the emulation processor.

CON(FIG) DTA(CK) MAP(LOCK)
Specifies that the memory map entries govern whether the emulator /DTACK or the target system /DTACK will terminate cycles.

CON(FIG) DTA(CK) TAR(GET)
Specifies that the target system /DTACK signal terminates cycles. Choose CON(FIG) DBC ENA(BLE) if you are going to use the monitor.

CON(FIG) DTA(CK) 0WA(IT)
Specifies that the /DTACK signal from the emulator be used to terminate cycles. The 0WAIT selection will run your program fastest.

CON(FIG) DTA(CK) 1WA(IT)
Specifies that the /DTACK signal from the emulator be used to terminate cycles. Use 1WAIT when running slow hardware at fast clock speeds.

CON(FIG) IAC(K7) AUT(O)
Specifies the PBCNT register determines use of the /IACK7/PB0 pin. The emulator blocks /IACK7 when executing monitor code unless you choose CON(FIG) DBC ENA(BLE).

CON(FIG) IAC(K7) ENA(BLE)
Specifies the pin is used as /IACK7. When executing the monitor, the emulator may block this pin.

Chapter 8: Menu Bar Commands

Settings→Emulator Config→Hardware... (ALT, S, E, H)

CON(FIG) IAC(K7) DIS(ABLE)

Specifies the pin is used as PB0.

CON(FIG) INT(R) AUT(O)

Specifies reading the GIMR register to know how to process interrupts.

CON(FIG) INT(R) NOR(MAL)

Specifies reading /IPL2-/IPL0 to determine the interrupt level and to process it.

CON(FIG) INT(R) LEV(EL)

Specifies reading /IRQ7, /IRQ6, and /IRQ1 to recognize interrupt requests. These lines are level sensitive.

CON(FIG) INT(R) EDG(E)

Specifies reading /IRQ7, /IRQ6, and /IRQ1 to recognize interrupt requests. These lines are edge sensitive.

Any of the above command file commands must be preceded and followed by the respective start and end commands:

CON(FIG) STA(RT)

Starts the configuration option command section.

CON(FIG) END

Ends the configuration option command section.

See Also

"Setting the Hardware Options" in the "Configuring the Emulator" chapter.

Settings→Emulator Config→Memory Map... (ALT, S, E, M)

Maps memory ranges.

You can map up to 8 address ranges (map terms). The minimum amount of emulation memory that can be allocated to a range is 512 bytes for 128-Kbyte memory boards and 1024 bytes for 512-Kbyte memory boards.

You can map ranges as emulation RAM, emulation ROM, target system RAM, target system ROM, or as guarded memory.

Guarded memory accesses cause emulator execution to break into the monitor program.

Writes to locations mapped as ROM will cause emulator execution to break into the monitor program if these breaks are enabled in the hardware configuration. Even so, emulation writes will modify the content of RAM memory that has been mapped as ROM.

Memory Map Dialog Box

Choosing the Settings→Emulator Config→Memory Map... (ALT, S, E, M) command opens the following dialog box:

Memory Map Config

Define Map Term

Start: **Apply**

End:

Func Code:

Type

eram Interlock DTACKs

erom Dual port

tram

trom

guarded

Default

tram trom guarded

Current Map

```
0000000..00003ff@x eram
0000400..0000fff@x erom
0001000..0002fff@x eram
0006000..000ffff@x eram
```

Available: 8000 bytes
Terms left: 4

Delete **Delete All**

Close **Help**

Start	Specifies the starting address of the address range to be mapped.
End	Specifies the end address of the address range to be mapped.
Func Code	Assigns any of the <i>function codes</i> to the address range. It is only necessary to specify a function code other than X (any function code) when mapping overlapping address ranges for different memory spaces. When mapping overlapping ranges, you can only select function codes that have not already been used for other members in the set of overlapping addresses.
Type	Lets you select the memory type of the specified address range.
Interlock DTACKs	Specifies that within the associated address range, accesses to emulation memory will be terminated by target system /DTACK (Data Transfer Acknowledge) instead of the emulation /DTACK signal.
Dual port	Specifies that one of the 8-Kbyte dual-port emulation memories will be used to contain the associated address range. (Dual-ported memory can be accessed by the host controller without the emulation monitor program, which means that your program executes uninterrupted during the access.)
Apply	Maps the address range specified in the Define Map Term group box.
Default	Specifies whether unmapped memory ranges are target system RAM, target system ROM, or guarded memory.
Current Map	Lists currently mapped ranges.
Available	Indicates the amount of emulation memory available.

Delete	Deletes the address range selected in the Current Map list box.
Delete All	Deletes all of the address ranges in the Current Map list box.
Close	Closes the dialog box.

Command File Command

`MAP addr-range memtype func_code attribute`

Maps the specified address range with the specified memory type, function code, and attribute. Attributes can be dp (dual-port memory), dti (use target /DTACK instead of emulation /DTACK), and dti,dp (both attributes).

`MAP OTH(ER) memtype`

Specifies the memory type of the non-mapped memory area.

Any of the above command file commands must be preceded and followed by the respective start and end commands:

`MAP STA(RT)`

Starts the memory mapping command section.

`MAP END`

Ends the memory mapping command section.

See Also

"Mapping Memory" in the "Configuring the Emulator" chapter.



Settings→Emulator Config→Information... (ALT, S, E, I)

This command lets you:

- Check the emulator configuration for inconsistencies.
- Display decoded and formatted information about the emulator configuration.
- Synchronize the 6830x system integration module (SIM) registers to the emulator's EMSIM registers.

Configuration Information Dialog Box

Two list boxes let you select the operation. Each has a button that confirms the selection. The results are displayed in the viewing area.

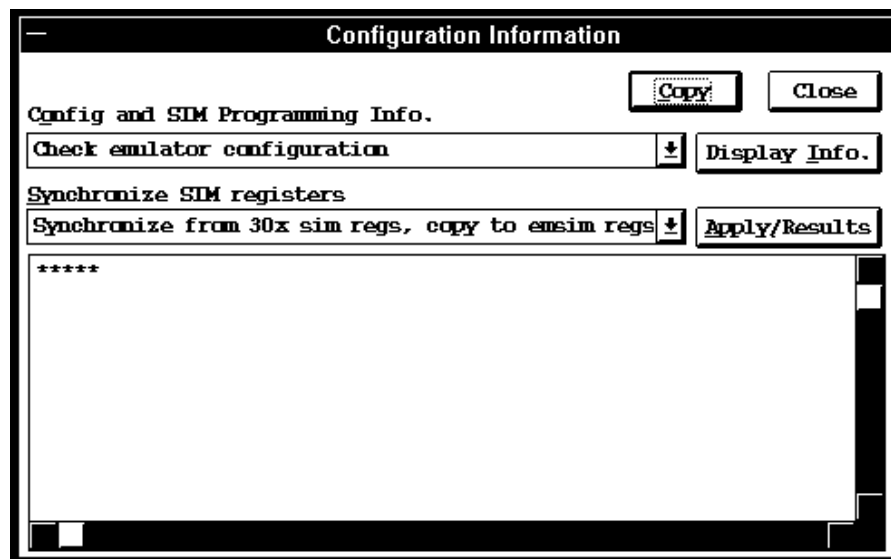

Config and SIM
Programming Info.

You can select:

Check emulator configuration which displays error messages that result from inconsistencies between related configuration values. These errors should be resolved for the emulator to operate correctly. In addition, status messages about expectations and limitations of the emulator are displayed.

Emulator clock, CLKOUT, & MODCK information which shows whether the emulator clock is internal or external, the type of clock source hardware, and the clock frequency.

Chip selects in SIM (processor) registers which shows how chip selects are defined.

Chip selects in EMSIM (emulator) registers which shows how chip selects are defined.

Bus interface A ports in SIM (processor) regs which shows the definitions of pins in bus interface port A.

Bus interface A ports in EMSIM (emulator) regs which shows the definitions of pins in bus interface port A.

Bus interface B ports in SIM (processor) regs which shows the definitions of pins in bus interface port B.

Bus interface B ports in EMSIM (emulator) regs which shows the definitions of pins in bus interface port B.

Bus interface N ports in SIM (processor) regs which shows the definitions of pins in bus interface port N.

Bus interface N ports in EMSIM (emulator) regs which shows the definitions of pins in bus interface port N.



Memory map & correlation with CSs, etc... which shows the memory map and its correlation with chip selects, internal module register block, and RAM.

Reset mode configuration value and operation which shows how the reset mode configuration is defined.

Assembly listing matching current EMSIM registers which shows the assembly language code that would initialize the processor to be the same as the current EMSIM register set.

Display Info. Performs the selected operation and displays the results in the viewing area.

Synchronize SIM registers You can select:

Synchronize from 30x sim regs, copy to emsim regs which programs the emulator's EMSIM registers from the 6830x SIM. This is useful if initialization code that configures the 6830x SIM exists, but you don't know what its values are. In this case, you can use the default configuration, run from reset to execute the initialization code, and synchronize the EMSIM registers to match the 6830x SIM.

Synchronize from emsim regs, copy to 30x registers which transfers the programming of the EMSIM registers into the 6830x SIM. This happens automatically each time a break to the monitor from emulation reset occurs; this ensures that the 6830x is prepared to properly access memory when a program is downloaded to the emulator.

Show differences for M6830x and emsim registers which compares corresponding values in the SIM and EMSIM register sets and shows differences between the two. If no differences are found, no registers will be shown in the list.

Default the emsim register set which resets the EMSIM registers to default processor values.

Apply/Results	Performs the selected operation and displays the results in the viewing area.
Copy	Opens a file selection dialog box that lets you can select the file to which information in the viewing area is copied.
Close	Closes the dialog box.

See Also

"Using the EMSIM Registers" in the "Configuring the Emulator" chapter.

"Verifying the Emulator Configuration" in the "Configuring the Emulator" chapter.



Settings→Communication... (ALT, S, C)

Choosing this command opens the RTC Emulation Connection Dialog Box which lets you identify and set up the communication channel between the personal computer and the HP 64700.

RTC Emulation Connection Dialog Box

Choosing the Settings→Communication... (ALT, S, C) command opens the following dialog box:

RTC Emulation Connection

Current Connection Status

Address: 15.6.263.153 User Name: Chris Smith
Status: Not Connected User ID: 5678
Transport: HP-ARPA

RTC Core Version Information

A.04.70 18Jun96 Unreleased
B3638AAJ4 6830X REAL-TIME C DEBUGGER

New Emulator Connection Setup

Transport Selection:

- HP-ARPA
- RS232C
- Novell-WP
- WINSOCK1.1
- HP-RS422
- W4WG-TCP

User Name: Chris Smith
User ID: 5678

Setup

Close
Help

Current Connection Status

This part of the dialog box shows the current communication settings.

RTC Core Version Information

Displays software version information.

New Emulator Connection Setup

Transport Selection Lets you choose the type of connection to be made to the HP 64700. Double-clicking causes the current connection to be tried with the given transport. Single-clicking selects the transport for use with the Setup button.

User Name This name tells the HP 64700 and other users who you are. When other users attempt to access the HP 64700 while you are using it or while it is locked, a message tells them you're using it.

User ID Another method of identifying yourself to the HP 64700 and other users. This is primarily useful in a mixed UNIX and MS-DOS environment; when a UNIX user tries to unlock an emulator, the user ID is used to look into the /etc/passwd entry on the UNIX host for the user name.

If your HP 64700 is on the LAN, we recommend that you change User Name and User ID so that other users can easily tell if an emulator is in use and by whom. Also, if you don't change the User Name/ID from the defaults, the File→Exit HW Locked (ALT, F, H) command has no effect because all users are identical.

Setup Opens a transport-specific dialog box which usually allows you to change the address and unlock the emulator

In the LAN Setup dialog boxes, enter the IP address or network name of the HP 64700.

In the RS232C Setup dialog box, select the baud rate and the name of the port (for example, COM1, COM2, etc.) to which the HP 64700 is connected.

In the HP-RS422 Setup dialog box, select the baud rate and specify the I/O address you want to use for the HP 64037 card. The I/O address must be a hexadecimal number from 100H through 3F8H, ending in 0 or 8, that does not conflict with other cards in your PC.

The Connect button in any of these Setup dialog boxes starts the debugger with the specified communication settings.

Close Either closes the Real-Time C Debugger, if the current connection failed, or simply closes the dialog box.

The Real-Time C Debugger does not allow you to change connection or transport information without leaving the debugger and reentering it. However, any changes you make will be put in the .INI file and take effect the next time you enter the debugger (assuming that you do not override the .INI information on the command line).

The command line options for connection and transport (-E and -T) take precedence over the values in the .INI file.

Settings→BNC→Outputs Analyzer Trigger (ALT, S, B, O)

Specifies that the analyzer trigger signal be driven on the BNC port.

Selecting the emulator BNC port for output enables the trigger signals to be fed to external devices (for example, logic analyzers) during tracing.

CAUTION

Do not drive the BNC beyond the range of 0 to 5 volts. Doing so may cause permanent damage to the HP 64700.

The BNC's drivers can drive 50 ohm loads.

The following is a logical diagram of the BNC connection. The physical implementation and values of resistors are not exact; this diagram is just to help you understand the BNC interface:

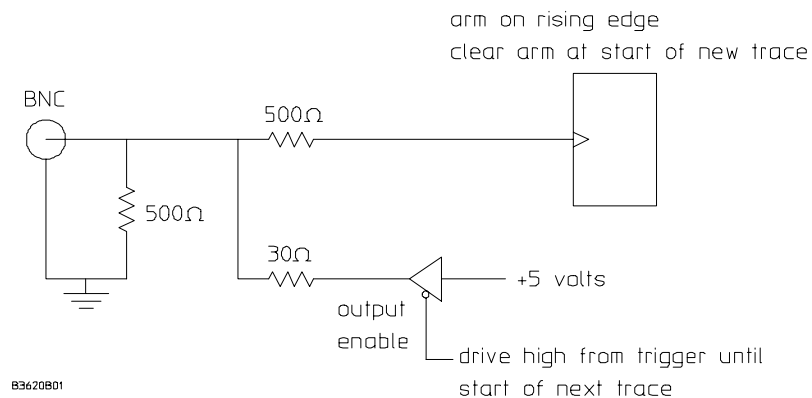

When a trace starts, it stops driving the output (so if nothing else is driving the line, it will fall low due to the 500 ohm pull-down resistor).

When the trigger point is found, the BNC starts driving the output high. It will stay high until the start of the next trace.

Command File Command

```
MOD(E) BNC OUT(PUT_TRIGGER)
```

Chapter 8: Menu Bar Commands

Settings→BNC→Outputs Analyzer Trigger (ALT, S, B, O)

See Also

"To output the trigger signal on the BNC port" in the "Setting Up the BNC Port" section of the "Configuring the Emulator" chapter.

Settings→BNC→Input to Analyzer Arm (ALT, S, B, I)

Allows the analyzer to receive an arm signal from the BNC port.

This command allows an external trigger signal to be used as an arm (enable) condition for the internal analyzer. The internal analyzer will arm (or enable) on a positive edge TTL signal.

CAUTION

Do not drive the BNC beyond the range of 0 to 5 volts. Doing so may cause permanent damage to the HP 64700.

You can use the arm condition when setting up custom trace specifications with the Trace→Find Then Trigger... (ALT, T, D) or Trace→Sequence... (ALT, T, Q) commands. For example, you can trigger on the arm condition or enable the storage of states on the arm condition. The "arm" condition may be selected in "set2" of the Trace Condition or Count Condition dialog boxes.

The BNC port is internally terminated with about 500 ohms; if using a 50 ohm driver, use an external 50 ohm termination (such as the HP 10100C 50 Ohm Feedthrough Termination) to reduce bouncing and possible incorrect triggering.

Command File Command

```
MOD(E) BNC INP(UT_ARM)
```

See Also

Settings→BNC→Outputs Analyzer Trigger (ALT, S, B, O) for a logical schematic of the BNC interface.

"To receive an arm condition input on the BNC port" in the "Setting Up the BNC Port" section of the "Configuring the Emulator" chapter.

Settings→Font... (ALT, S, F)

Selects the fonts used in the debugger windows.

Font Dialog Box

Choosing the Settings→Font... (ALT, S, F) command opens the following dialog box:

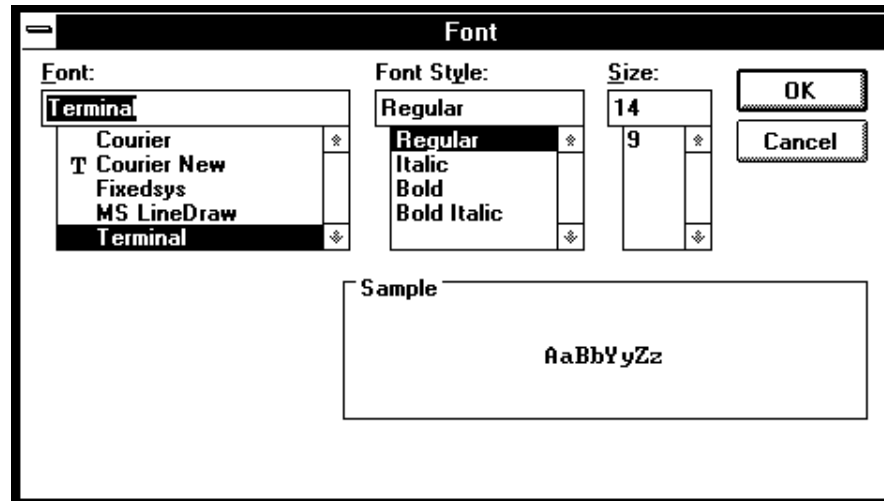

Font	Lets you select the font to be used in the Real-Time C Debugger interface. The "T" shaped icon indicates a TrueType font.
Font Style	Lets you select the typeface, for example, regular, bold, italic, etc.
Size	Lets you select the size of the characters.
Sample	Shows you what the selected font looks like.
OK	Sets the font, and closes the dialog box.
Cancel	Cancels font setting, and closes the dialog box.

See Also

"To change the debugger window fonts" in the "Working with Debugger Windows" section of the "Using the Debugger Interface" chapter.



Settings→Tabstops... (ALT, S, T)

Sets the number of spaces between tab stops.

Source Tab Dialog Box

Choosing the Settings→Tabstops... (ALT, S, T) command opens the following dialog box:

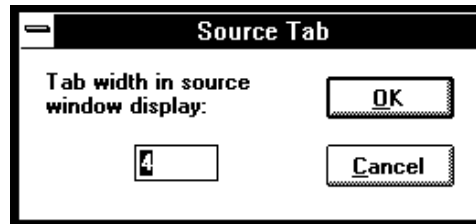

Tab width in source window display Enter the number of spaces between tab stops. This also affects the tab width for source lines in the Trace window.

OK Sets the tab stops, and closes the dialog box.

Cancel Cancels tab stop setting, and closes the dialog box.

See Also

"To set tab stops in the Source window" in the "Working with Debugger Windows" section of the "Using the Debugger Interface" chapter.

Settings→Symbols→Case Sensitive→ON (ALT, S, S, C, O)

Symbol database search is case sensitive.

Command File Command

```
MOD(E) SYM(BOLCASE) ON
```

See Also

Settings→Symbols→Case Sensitive→OFF (ALT, S, S, C, F)

Settings→Symbols→Case Sensitive→OFF (ALT, S, S, C, F)

Symbol database search is not case sensitive.

If there are case conflicts (for example, FOO and foo), no warning is given, and you cannot predict which symbol will be used. The symbol that is used depends on what type of symbols FOO and foo are and how they were input by the symbol section of the object file.

Command File Command

```
MOD(E) SYM(BOLCASE) OFF
```

See Also

Settings→Symbols→Case Sensitive→ON (ALT, S, S, C, O)

Settings→Extended→Trace Cycles→User (ALT, S, X, T, U)

Traces foreground emulation microprocessor operation.

This is the normal setting.

Command File Command

```
MOD(E) TRA(CECLOCK) USE(R)
```

See Also

Settings→Extended→Trace Cycles→Monitor (ALT, S, X, T, M)

Settings→Extended→Trace Cycles→Both (ALT, S, X, T, B)

Settings→Extended→Trace Cycles→Monitor (ALT, S, X, T, M)

Traces background emulation microprocessor operation.

This is rarely a useful setting when debugging programs.

Command File Command

```
MOD(E) TRA(CECLOCK) BAC(KGROUND)
```

See Also

Settings→Extended→Trace Cycles→User (ALT, S, X, T, U)

Settings→Extended→Trace Cycles→Both (ALT, S, X, T, B)

Settings→Extended→Trace Cycles→Both (ALT, S, X, T, B)

Traces both foreground and background emulation microprocessor operation.

Command File Command

```
MOD(E) TRA(CECLOCK) BOT(H)
```

See Also

Settings→Extended→Trace Cycles→User (ALT, S, X, T, U)

Settings→Extended→Trace Cycles→Monitor (ALT, S, X, T, M)



Settings→Extended→Load Error Abort→ON (ALT, S, X, L, O)

An error during an object file or memory load causes an abort.

Normally, when an error occurs during an object file or memory load, you want the load to stop so that you can fix whatever caused the error.

Command File Command

MOD(E) DOW(NLOAD) ERR(ABORT)

See Also

Settings→Extended→Load Error Abort→OFF (ALT, S, X, L, F)

Settings→Extended→Load Error Abort→OFF (ALT, S, X, L, F)

An error during an object file or memory load does not cause an abort.

If you expect certain errors during an object file or memory load, for example, if part of the file is located at "guarded" memory or "target ROM," you can choose this command to continue loading in spite of the errors.

Command File Command

MOD(E) DOW(NLOAD) NOE(RRABORT)

See Also

Settings→Extended→Load Error Abort→ON (ALT, S, X, L, O)

Settings→Extended→Source Path Query→ON (ALT, S, X, S, O)

You are prompted for source file paths.

When the debugger cannot find source file information for the Source or Trace windows, it may prompt you for source file paths depending on the MODE SOURCE setting.

Command File Command

MOD(E) SOU(RCE) ASK(PATH)

See Also

Settings→Extended→Source Path Query→OFF (ALT, S, X, S, F)

Settings→Extended→Source Path Query→OFF (ALT, S, X, S, F)

You are not prompted for source file paths.

You can turn off source path prompting, for example, to avoid annoying dialog interactions when tracing library functions for which no source files are available.

Command File Command

MOD(E) SOU(RCE) NOA(SKPATH)

See Also

Settings→Extended→Source Path Query→ON (ALT, S, X, S, O)

Window→Cascade (ALT, W, C)

Arranges, sizes, and overlaps windows.

Windows are sized, evenly, to be as large as possible.

Window→Tile (ALT, W, T)

Arranges and sizes windows so that none are overlapped.

Windows are sized evenly.

Window→Arrange Icons (ALT, W, A)

Rearranges icons in the Real-Time C Debugger window.

Icons are distributed evenly along the lower edge of the Real-Time C Debugger window.

Window→1-9 (ALT, W, 1-9)

Opens the window associated with the number.

The nine most recently opened windows appear in the menu list. If the window you wish to open is not on the list, choose the Window→More Windows... (ALT, W, M) command.

Windows are closed just as are ordinary MS Windows, that is, by opening the control menu and choosing Close or by pressing CTRL+F4.

For details on each of the debugger windows, refer to the "Debugger Windows" section in the "Concepts" information.

Command File Command

DIS(PLAY) window-name

Opens the specified window. Use the first three characters of the window name, or, if the window name is "Basic Registers," use "REG."

ICO(NIC) window-name

Closes the specified window. Use the first three characters of the window name, or, if the window name is "Basic Registers," use "REG."

See Also

"To open debugger windows" in the "Working with Debugger Windows" section of the "Using the Debugger Interface" chapter.



Window→More Windows... (ALT, W, M)

Presents a list box from which you can select the window to be opened.

Select Window Dialog Box

Choosing the Window→More Windows... (ALT, W, M) command opens the following dialog box:

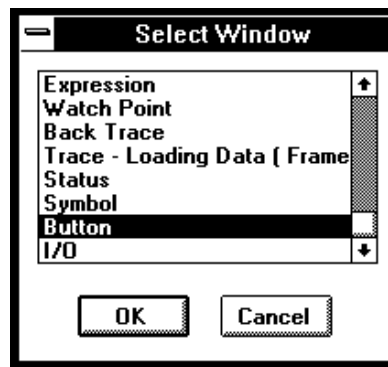

OK Opens the window selected in the list box.

Cancel Closes the dialog box.

Command File Command

DIS(PLAY) window-name

Opens the specified window. Use the first three characters of the window name, or, if the window name is "Basic Registers," use "REG."

ICO(NIC) window-name

Closes the specified window. Use the first three characters of the window name, or, if the window name is "Basic Registers," use "REG."

See Also

"To open debugger windows" in the "Working with Debugger Windows" section of the "Using the Debugger Interface" chapter.

Help→About Debugger/Emulator... (ALT, H, D)

Provides information on the Real-Time C Debugger.

Choosing the Help→About Debugger/Emulator... (ALT, H, D) command opens a dialog box containing the version information on the current Real-Time C Debugger and emulator.



Source Directory Dialog Box

When the source file associated with a symbol cannot be found in the current directory, the following dialog box is opened:

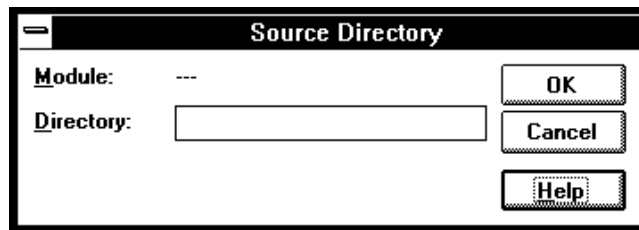

Module	Shows the symbol whose source file could not be found.
Directory	Lets you enter the directory in which the source file associated with the symbol may be found.
OK	Adds the directory entered in the Directory text box to the source file search path.
Cancel	Closes the dialog box.

WAIT Command Dialog Box

This dialog box appears when the WAIT command is included in a command file, break macro, or button.

Choosing the STOP button cancels the WAIT command.





Window Control Menu Commands

Window Control Menu Commands

This chapter describes the commands that can be chosen from the *control menus* in debugger windows.

- Common Control Menu Commands
- Button Window Commands
- Device Regs Window Commands
- Expression Window Commands
- I/O Window Commands
- Memory Window Commands
- Register Window Commands
- Source Window Commands
- Symbol Window Commands
- Trace Window Commands
- WatchPoint Window Commands

Common Control Menu Commands

This section describes commands that appear in the control menus of most of the debugger windows:

- Copy→Window (ALT, -, P, W)
- Copy→Destination... (ALT, -, P, D)

Copy→Window (ALT, -, P, W)

Copies the current window contents to the destination file specified with the File→Copy Destination... (ALT, F, P) command.

Command File Command

COP(Y) BAC(KTRACE)

COP(Y) BUT(TON)

COP(Y) EXP(RESSION)

COP(Y) IO

COP(Y) MEM(ORY)

COP(Y) REG(ISTER)

COP(Y) SOU(RCE)

COP(Y) WAT(CHPOINT)

See Also

"To copy window contents to the list file" in the "Working with Debugger Windows" section of the "Using the Debugger Interface" chapter.

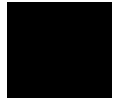

Copy→Destination... (ALT, -, P, D)

Names the listing file to which debugger information may be copied.

This command opens a file selection dialog box from which you can select the listing file. Listing files have the extension ".LST".

Command File Command

COP(Y) TO filename

See Also

"To change the list file destination" in the "Working with Debugger Windows" section of the "Using the Debugger Interface" chapter.

Button Window Commands

This section describes the following command:

- Edit... (ALT, -, E)

Edit... (ALT, -, E)

Lets you define and label buttons in the Button window.

You can set up buttons to execute commonly used commands or command files.

Note that the Copy→Window command will generate a listing file that contains a header followed by commands needed to recreate the buttons. By removing the header, this file may be used as a command file.

Alternatively, you can log commands to a command file as you edit the buttons (refer to To create a command file in the "Using Command Files" section of the "Using the Debugger Interface" chapter). To recreate the buttons, just run the command file that you created while editing the buttons.

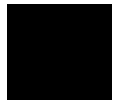

Button Edit Dialog Box

Choosing the Edit... (ALT, -, E) command opens the following dialog box:

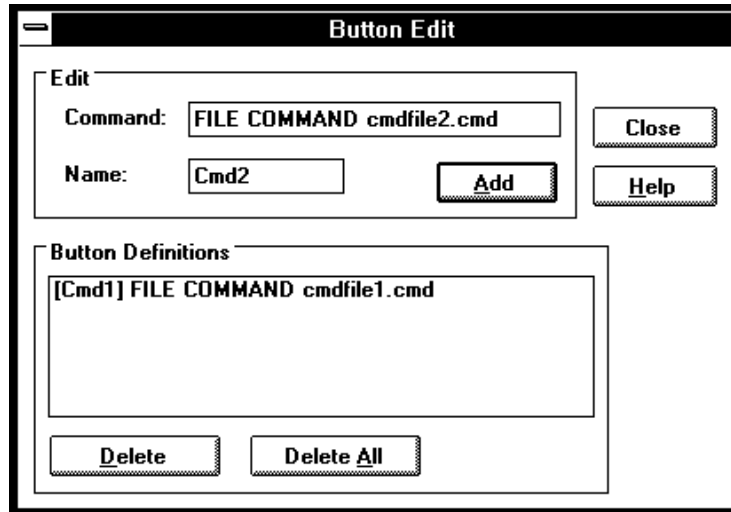

Command Specifies the command to be associated with the button. Command syntax is described at the bottom of most help topics under the "Command File Command" heading. Also, look in the "Command File and Macro Command Summary" chapter in the "Reference" part.

You can only enter a single command here; if you want a series of commands to be executed when this button is used, put them in a command file and use the command "FILE COMMAND filename," where "filename" is the name of your command file.

Name Specifies the button label to be associated with the command.

Add Adds the button to the button window.

Button Definitions Lists the currently defined buttons. You can select button definitions for deletion by clicking on them.

- | | |
|------------|--|
| Delete | Deletes the button definition selected in the Button Definitions list box. |
| Delete All | Deletes all buttons from the Button window. |
| Close | Closes the dialog box. |

Command File Command

BUTTON label "command"

BUTTON DELETE label

BUTTON DELETEALL

See Also

"To create buttons that execute command files" in the "Using Command Files" section of the "Using the Debugger Interface" chapter.

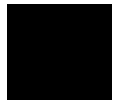

Device Regs Window Commands

This section describes the following command:

- Continuous Update (ALT, -, U)

Continuous Update (ALT, -, U)

Specifies whether the Device Regs window contents should be continuously updated while running programs.

A check mark (✓) next to the command shows that continuous update is active.

Expression Window Commands

This section describes the following commands:

- Clear (ALT, -, R)
- Evaluate... (ALT, -, E)

Clear (ALT, -, R)

Erases the contents of the Expression window.

Command File Command

EVA(LUATE) CLE(AR)



Evaluate... (ALT, -, E)

Evaluates expressions and displays the results in the Expression window.

Evaluate Expression Dialog Box

Choosing the Evaluate... (ALT, -, E) command opens the following dialog box:

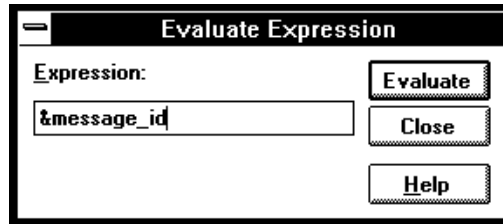

Expression Lets you enter the expression to be evaluated.

Evaluate Makes the evaluation and places the results in the Expression window.

Close Closes the dialog box.

Command File Command

EVA(LUATE) address

EVA(LUATE) "strings"

See Also

"Symbols" in the "Expressions in Commands" chapter.

I/O Window Commands

This section describes the following command:

Define... (ALT, -, D)

Define... (ALT, -, D)

Adds or deletes memory mapped I/O locations from the I/O window.

I/O Setting Dialog Box

Choosing the Edit→Definition... command opens the following dialog box:

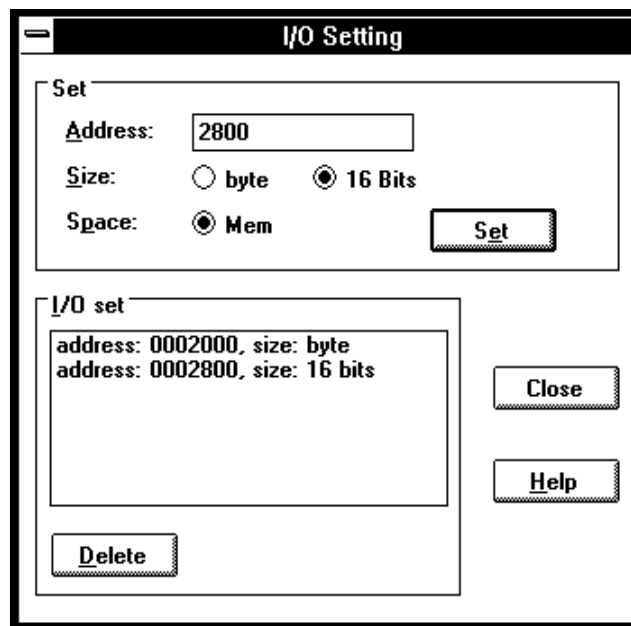

Chapter 9: Window Control Menu Commands
I/O Window Commands

Address	Specifies the address of the I/O location to be defined.
Size	Specifies the data format of the I/O location to be defined. You can select the Byte or 16 Bits option.
Space	Specifies whether the I/O location is in memory or I/O space.
Set	Adds the specified I/O location.
I/O set	Displays the information on the I/O locations that have been set.
Delete	Deletes the I/O locations selected in the I/O set list box.
Close	Closes the dialog box.

Command File Command

`IO BYTE/WORD/LONG IOSPACE/MEMORY address TO data`
Replaces the contents of the specified I/O address with the specified value in the specified size.

`IO SET BYTE/WORD/LONG IOSPACE/MEMORY address`
Registers the I/O address to be displayed in the specified size.

`IO DEL(ETE) BYTE/WORD/LONG IOSPACE/MEMORY address`
Deletes the I/O specified with its address and size.

See Also

"Displaying and Editing I/O Locations" in the "Debugging Programs" chapter.

Memory Window Commands

This section describes the following commands:

- Display→Linear (ALT, -, D, L)
- Display→Block (ALT, -, D, B)
- Display→Byte (ALT, -, D, Y)
- Display→16 Bits (ALT, -, D, 1)
- Display→32 Bits (ALT, -, D, 3)
- Search... (ALT, -, R)
- Utilities→Copy... (ALT, -, U, C)
- Utilities→Fill... (ALT, -, U, F)
- Utilities→Image... (ALT, -, U, I)
- Utilities→Load... (ALT, -, U, L)
- Utilities→Store... (ALT, -, U, S)

Display→Linear (ALT, -, D, L)

Displays memory contents in single column format.

Command File Command

MEM(ORY) ABS(OLUTE)

Display→Block (ALT, -, D, B)

Displays memory contents in multicolumn format.

Command File Command

MEM(ORY) BLO(CK)

Display→Byte (ALT, -, D, Y)

Displays memory contents as bytes.

Command File Command

MEM(ORY) BYTE

Display→16 Bit (ALT, -, D, 1)

Displays memory contents as 16-bit values.

Command File Command

MEM(ORY) WORD

Display→32 Bit (ALT, -, D, 3)

Displays memory contents as 32-bit values.

Command File Command

MEM(ORY) LONG

Search... (ALT, -, R)

Searches for a value or string in a range of memory.

When the value or string is found, the location is displayed in the Memory window. Choose the Window→Memory command to open the window.

The value or string can be selected from another window (in other words, copied to the clipboard) before choosing the command; the contents of the clipboard will automatically appear in the dialog box that is opened.

Search Memory Dialog Box

Choosing the Search... (ALT, -, R) command opens the following dialog box:

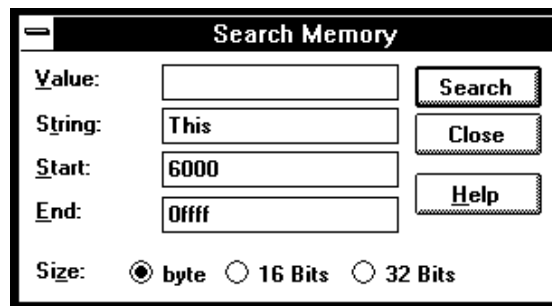

Value	Lets you enter a value.
String	Lets you enter a string.
Start	Lets you enter the starting address of the memory range to search.
End	Lets you enter the end address of the memory range to search.
Size	Selects the data size using the Byte, 16 Bits, or 32 Bits option buttons.
Execute	Searches for the specified value or string.

Close Closes the dialog box.

Command File Command

SEA(RCH) MEM(ORY) BYTE/WORD/LONG addr_range value

SEA(RCH) MEM(ORY) STR(ING) "string"

See Also

"To search memory for a value or string" in the "Displaying and Editing Memory" section of the "Debugging Programs" chapter.

Utilities→Copy... (ALT, -, U, C)

Copies the contents of one memory area to another.

Memory Copy Dialog Box

Choosing the Utilities→Copy... (ALT, -, U, C) command opens the following dialog box:

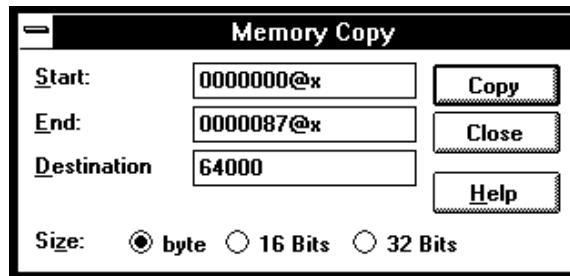

Start	Lets you enter the starting address of the source memory area.
End	Lets you enter the end address of the source memory area.
Destination	Specifies the starting address of the destination memory area.
Size	Selects the data size using the Byte, 16 Bits, or 32 Bits option buttons.
Execute	Copies the memory contents.
Close	Closes the dialog box.

Command File Command

MEM(ORY) COP(Y) size address_range address

See Also

"To copy memory to a different location" in the "Displaying and Editing Memory" section of the "Debugging Programs" chapter.

Utilities→Fill... (ALT, -, U, F)

Fills a range of memory with a specified value.

Memory Fill Dialog Box

Choosing the Utilities→Fill... (ALT, -, U, F) command opens the following dialog box:

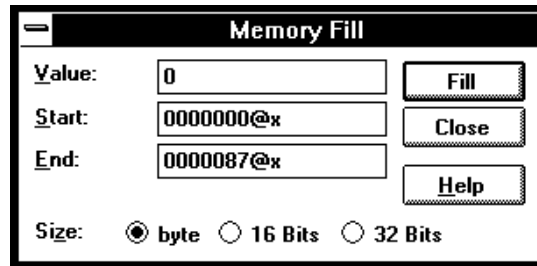

Value	Lets you enter the filling value.
Start	Lets you enter the starting address of the memory area to be filled.
End	Lets you enter the end address of the memory area to be filled.
Size	Selects the size of the filling value. If the value specified is larger than can fit in the size selected, the upper bits of the value are ignored. You can select the size using the Byte, 16 Bits, or 32 Bits option buttons.
Execute	Executes the command.

Close Closes the dialog box.

Command File Command

MEM(ORY) FIL(L) size address_range data

See Also

"To modify a range of memory with a value" in the "Displaying and Editing Memory" section of the "Debugging Programs" chapter.

Utilities→Image... (ALT, -, U, I)

Copies the contents of a target system memory range into the corresponding emulation memory range.

You can copy programs that are in target system ROM to emulation memory. Once the program code is in emulation memory, you can use features like breakpoints, run until, etc.

The address range must be mapped as emulation memory before choosing this command.

Memory Image Dialog Box

Choosing the Utilities→Image... (ALT, -, U, I) command opens the following dialog box:

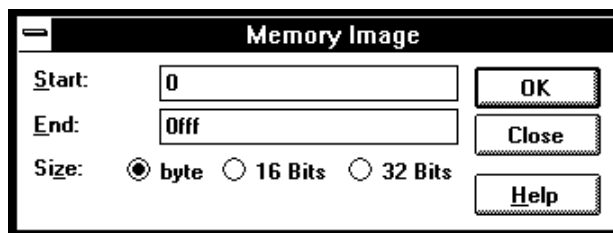

Chapter 9: Window Control Menu Commands
Memory Window Commands

Start	Lets you enter the starting address of the memory area.
End	Lets you enter end address of the memory area.
Size	Selects the data size using the Byte, 16 Bits, or 32 Bits option buttons.
Execute	Copies the target system memory into emulation memory.
Close	Closes the dialog box.

Command File Command

`MEM(ORY) IMA(GE) size address_range`

See Also

"To copy target system memory into emulation memory" in the "Displaying and Editing Memory" section of the "Debugging Programs" chapter.

Utilities→Load... (ALT, -, U, L)

Loads memory contents from a previously stored file.

Load Binary File Dialog Box

Choosing the Utilities→Load... (ALT, -, U, L) command opens the following dialog box:

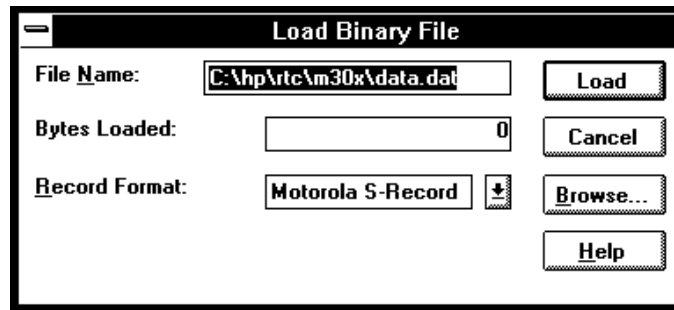

File Name Lets you enter the name of the file to load memory from.

Bytes Loaded After you choose the Import button, this box shows the number of bytes that are loaded.

Record Format Lets you specify the format of the file from which you're loading memory. You can load Motorola S-Record or Intel Hexadecimal format files.

Load Starts the memory load.

Cancel Closes the dialog box.

Browse... Opens a file selection dialog box from which you can select the file name.

Command File Command

```
MEM(ORY) LOA(D) MOT(OSREC) filename
```

```
MEM(ORY) LOA(D) INT(ELHEX) filename
```

See Also

"To copy target system memory into emulation memory" in the "Displaying and Editing Memory" section of the "Debugging Programs" chapter.

Utilities→Store... (ALT, -, U, S)

Utilities→Store... (ALT, -, U, S)

Stores memory contents to a binary file.

Store Binary File Dialog Box

Choosing the Utilities→Store... (ALT, -, U, S) command opens the following dialog box:

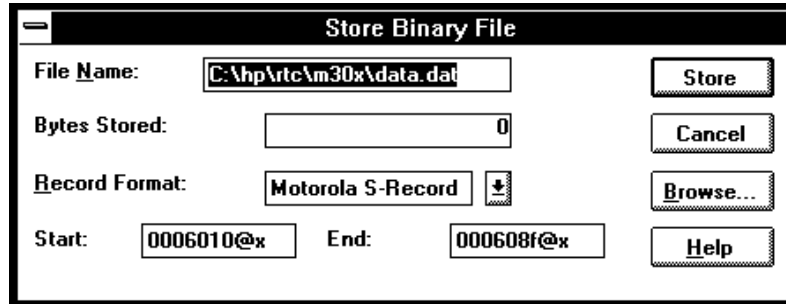

- File Name** Lets you enter the name of the file to which memory contents are stored.
- Bytes Stored** After you choose the Export button, this box shows the number of bytes that are stored.
- Record Format** Lets you specify the format of the file to which you're storing memory. You can select Motorola S-Record or Intel Hexadecimal formats.

Start	Lets you enter the starting address of the memory range to be stored.
End	Lets you enter the ending address of the memory range to be stored.
Store	Starts the memory store.
Cancel	Closes the dialog box.
Browse...	Opens a file selection dialog box from which you can select a file name.

Command File Command

MEM(ORY) STO(RE) MOT(OSREC) addr-range filename

MEM(ORY) STO(RE) INT(ELHEX) addr-range filename

See Also

"To copy target system memory into emulation memory" in the "Displaying and Editing Memory" section of the "Debugging Programs" chapter.

Utilities→Load... (ALT, -, U, L)

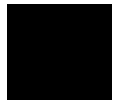

Register Window Commands

This section describes the following command:

Copy→Registers (ALT, -, P, R)

Copy→Registers (ALT, -, P, R)

Copies the current Register window contents to the destination file specified with the File→Copy Destination... (ALT, F, P) command.

Command File Command

COPY REGISTER

Register Bit Fields Dialog Box

When a register has bit-fields, a dialog will pop-up and the register value may be edited by changing the whole value or by editing individual bit-fields.

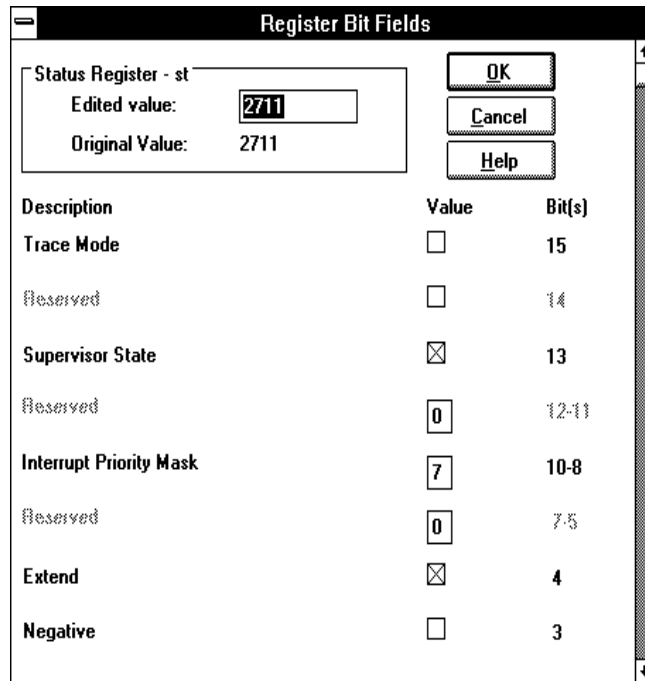

When editing in the dialog box, a carriage-return is the same as choosing the OK button. To end an edit of a field within the dialog box without quitting, use the Tab key.

Edited Value Shows the register value that corresponds to the selections made below. You can also change the register's value by modifying the value in this text box.

Original Value Shows the value of the register when the dialog box was opened. If the register could not be read, 'XXXXXXXX' is displayed.

Chapter 9: Window Control Menu Commands
Register Window Commands

OK	Modifies the register as specified, and closes the dialog box.
Cancel	Closes the dialog box without modifying the register.

Source Window Commands

This section describes the following commands:

- Display→Mixed Mode (ALT, -, D, M)
- Display→Source Only (ALT, -, D, S)
- Display→Select Source... (ALT, -, D, L)
- Search→String... (ALT, -, R, S)
- Search→Function... (ALT, -, R, F)
- Search→Address... (ALT, -, R, A)
- Search→Current PC (ALT, -, R, C)

Display→Mixed Mode (ALT, -, D, M)

Chooses the source/mnemonic mixed display mode.

Command File Command

MOD(E) MNE(MONIC) ON

See Also

"To display source code mixed with assembly instructions" in the "Loading and Displaying Programs" section of the "Debugging Programs" chapter.

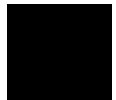

Display→Source Only (ALT, -, D, S)

Chooses the source only display mode.

Command File Command

MOD(E) MNE(MONIC) OFF

See Also

"To display source code only" in the "Loading and Displaying Programs" section of the "Debugging Programs" chapter.

Display→Select Source... (ALT, -, D, L)

Displays the contents of the specified C source file in the Source window.

This command is disabled before the object file is loaded or when no source is available for the loaded object file.

Select Source Dialog Box

Choosing the Display→Select Source... (ALT, -, D, L) command opens the following dialog box:

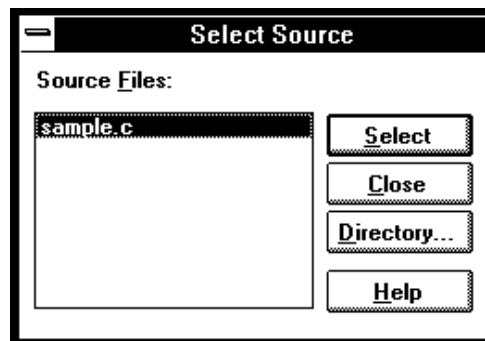

Source Files	Lists C source files associated with the loaded object file. You can select the source file to be displayed from this list.
Select	Switches the Source window contents to the selected source file.
Close	Closes the dialog box.
Directory	Opens the Search Directories Dialog Box from which you can add directories to the search path.

Command File Command

`FIL(E) SOU(RCE) module_name`

See Also

"To display source files by their names" in the "Loading and Displaying Programs" section of the "Debugging Programs" chapter.

Search→String... (ALT, -, R, S)

Searches for, and displays, a string in the Source window.

The search starts from the current cursor position in the Source window, may be either forward or backward, and may be case sensitive.

The string can be selected from another window (in other words, copied to the clipboard) before choosing the command; it will automatically appear in the dialog box that is opened.

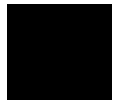

Search String Dialog Box

Choosing the Search→String... (ALT, -, R, S) command opens the following dialog box:

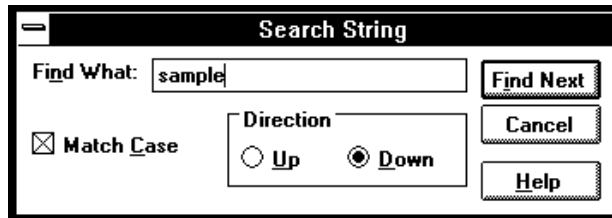

Find What	Lets you enter the string.
Match Case	Selects or deselects case matching.
Up	Specifies that the search be from the current cursor position backward.
Down	Specifies that the search be from the current cursor position forward.
Find Next	Searches for the string.
Close	Closes the dialog box.

Command File Command

SEA(RCH) STR(ING) FOR/BACK ON/OFF strings
Searches the specified string in the specified direction with the case matching option ON or OFF.

See Also

"To search for strings in the source files" in the "Loading and Displaying Programs" section of the "Debugging Programs" chapter.

Search→Function... (ALT, -, R, F)

Searches for, and displays, a function in the Source window.

The object file and symbols must be loaded before you can choose this command.

Note

This command displays the source file based on the function information in the object file. Depending on the structure of the function, the command may fail in displaying the declaration of the function.

Search Function Dialog Box

Choosing the Search→Function... (ALT, -, R, F) command opens the following dialog box:

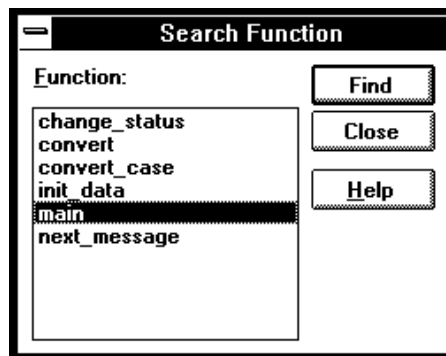

Function Lets you select the function to search for.

Find Searches the specified function.

Close Closes the dialog box.

Command File Command

SEA(RCH) FUNC(TION) func_name

See Also

"To search for function names in the source files" in the "Loading and Displaying Programs" section of the "Debugging Programs" chapter.

Search→Address... (ALT, -, R, A)

Searches for, and displays, an address in the Source window.

Address expressions such as function names or symbols can be selected from another window (in other words, copied to the clipboard) before choosing the command; the contents of the clipboard will automatically appear in the dialog box that is opened.

Search Address Dialog Box

Choosing the Search→Address... (ALT, -, R, A) command opens the following dialog box:

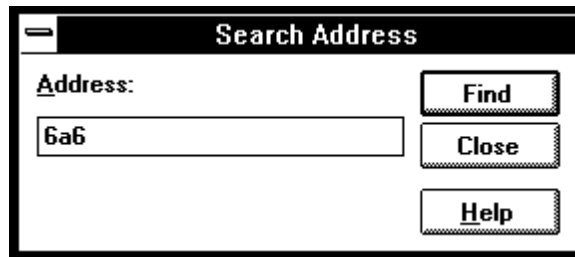

- | | |
|---------|---|
| Address | Lets you enter the address to search for. |
| Find | Searches for the specified address. |
| Close | Closes the dialog box. |

Command File Command

CUR(SOR) address

When used before the COME command, this command can be used to run to a particular address.

See Also

"To search for addresses in the source files" in the "Loading and Displaying Programs" section of the "Debugging Programs" chapter.

Search→Current PC (ALT, -, R, C)

Searches for, and displays, the location of the current program counter in the Source window.

Command File Command

CUR(SOR) PC

This command can be used to show the current PC in the Source window.

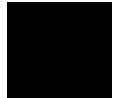

Search Directories Dialog Box

Choosing the Directories... button in the Select Source dialog box opens the following dialog box:

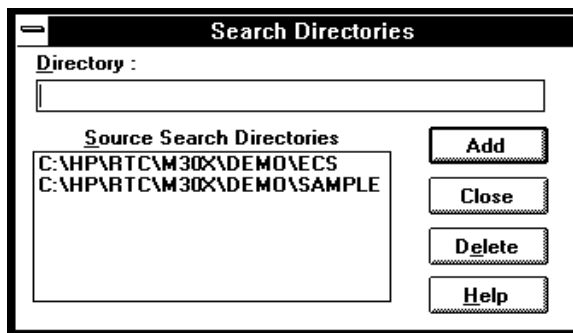

Directory	Lets you enter the directory to be added to the source file search path.
Search Source Directories	Lists the directories in the source file search path.
Add	Adds the directory entered in the Directory text box to the source file search path.
Delete	Deletes the directory in the Directory text box from the source file search path.
Close	Closes the dialog box.

See Also

"To specify source file directories" in the "Loading and Displaying Programs" section of the "Debugging Programs" chapter.

Symbol Window Commands

This section describes the following commands:

- Display→Modules (ALT, -, D, M)
- Display→Functions (ALT, -, D, F)
- Display→Externals (ALT, -, D, E)
- Display→Locals... (ALT, -, D, L)
- Display→Asm Globals (ALT, -, D, G)
- Display→Asm Locals... (ALT, -, D, A)
- Display→User defined (ALT, -, D, U)
- Copy→Window (ALT, -, P, W)
- Copy→All (ALT, -, P, A)
- FindString→String... (ALT, -, D, M)
- User defined→Add... (ALT, -, U, A)
- User defined→Delete (ALT, -, U, D)
- User defined→Delete All (ALT, -, U, L)

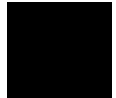

Display→Modules (ALT, -, D, M)

Displays the symbolic module information from the loaded object file.

Command File Command

`SYM(BOL) LIS(T) MOD(ULE)`

See Also

"To display program module information" in the "Displaying Symbol Information" section of the "Debugging Programs" chapter.

Display→Functions (ALT, -, D, F)

Displays the symbolic function information from the loaded object file.

The Symbol window displays the name, type and address range for C functions.

Command File Command

`SYM(BOL) LIS(T) FUN(CTION)`

See Also

"To display function information" in the "Displaying Symbol Information" section of the "Debugging Programs" chapter.

Display→Externals (ALT, -, D, E)

Displays the global variable information from the loaded object file.

The Symbol window displays the name, type and address for global variables.

Command File Command

`SYM(BOL) LIS(T) EXT(ERNAL)`

See Also

"To display external symbol information" in the "Displaying Symbol Information" section of the "Debugging Programs" chapter.

Display→Locals... (ALT, -, D, L)

Displays the local variable information on the specified function.

The function name can be selected from another window (in other words, copied to the clipboard) before choosing the command; the clipboard contents automatically appear in the dialog box that is opened.

The Symbol window displays the name, type and offset from the frame pointer for the local variables for the specified function.

Local Symbol Dialog Box

Choosing the Display→Locals... (ALT, -, D, L) command opens the following dialog box:

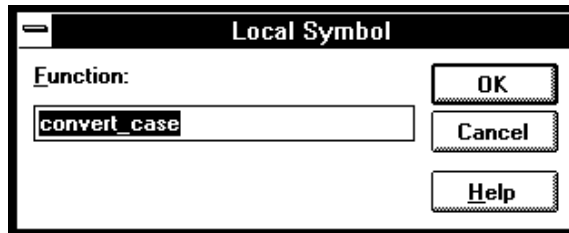

- | | |
|----------|---|
| Function | Selects the function for which the local variable information is displayed. |
| OK | Executes the command and closes the dialog box. |
| Cancel | Cancels the command and closes the dialog box. |

Command File Command

`SYM(BOL) LIS(T) INT(ERNAL) function`

See Also

"To display local symbol information" in the "Displaying Symbol Information" section of the "Debugging Programs" chapter.

Display→Asm Globals (ALT, -, D, G)

Displays the global Assembler symbol information from the loaded object file.

The Symbol window displays the name and address for the global assembler symbols.

Command File Command

SYM(BOL) LIS(T) GLO(BALS)

See Also

"To display global assembler symbol information" in the "Displaying Symbol Information" section of the "Debugging Programs" chapter.

Display→Asm Locals... (ALT, -, D, A)

Displays the local symbol information from the specified module.

The module name can be selected from another window (in other words, copied to the clipboard) before choosing the command; the clipboard contents automatically appear in the dialog box that is opened.

The Symbol window displays the name and address for the local symbols for the specified module.

Assembler Symbol Dialog Box

Choosing the Display→Asm Locals... (ALT, -, D, A) command opens the following dialog box:

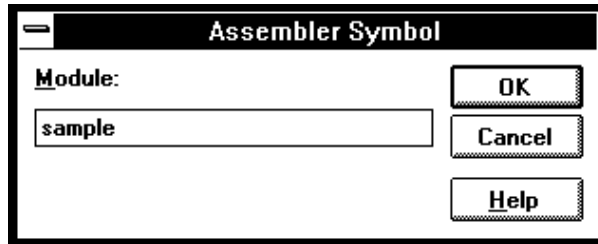

- | | |
|--------|---|
| Module | Selects the module for which the local symbols are displayed. |
| OK | Executes the command and closes the dialog box. |
| Cancel | Cancels the command and closes the dialog box. |

Command File Command

SYM(BOL) LIS(T) LOC(AL) module

See Also

"To display local assembler symbol information" in the "Displaying Symbol Information" section of the "Debugging Programs" chapter.

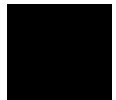

Display→User defined (ALT, -, D, U)

Displays the user-defined symbol information.

The Symbol window displays the name and address for the user-defined symbols.

The User defined→Add... (ALT, -, D, U) command adds the user-defined symbols.

Command File Command

`SYM(BOL) LIS(T) USE(R)`

See Also

"To display user-defined symbol information" in the "Displaying Symbol Information" section of the "Debugging Programs" chapter.

Copy→Window (ALT, -, P, W)

Copies the information currently displayed in the Symbol window to the specified listing file.

The listing file is specified with the File→Copy Destination... (ALT, F, P) command.

Command File Command

`SYM(BOL) COP(Y) DIS(PLAY)`

See Also

"To copy window contents to the list file" in the "Working with Debugger Windows" section of the "Using the Debugger Interface" chapter.

Copy→All (ALT, -, P, A)

Copies all the symbol information to the specified listing file.

The listing file is specified with the File→Copy Destination... (ALT, F, P) command.

Command File Command

SYM(BOL) COP(Y) ALL

FindString→String... (ALT, -, F, S)

Displays the symbols that contain the specified string.

This command performs a case-sensitive search.

Symbol Matches Dialog Box

Choosing the FindString→String... (ALT, -, F, S) command opens the following dialog box:

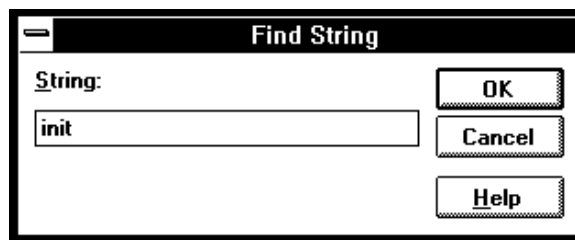

String	Specifies the string.
OK	Executes the command and closes the dialog box.
Cancel	Cancels the command and closes the dialog box.

Command File Command

SYM(BOL) MAT(CH) string

See Also

"To display the symbols containing the specified string" in the "Displaying Symbol Information" section of the "Debugging Programs" chapter.

User defined→Add... (ALT, -, U, A)

Adds the specified user-defined symbol.

User-defined symbols may be used in debugger commands just like other program symbols.

The symbol name must satisfy the following requirements:

- The name must begin with an alphabetical, _ (underscore), or ? character.
- The following characters must be any of alphanumerical, _ (underscore), or ? characters.
- The maximum number of characters is 256.

User defined Symbol Dialog Box

Choosing the User defined→Add... (ALT, -, U, A) command opens the following dialog box:

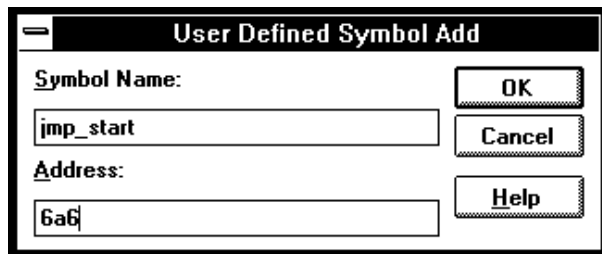

Symbol Name	Specifies the symbol to be added.
Address	Specifies the address of the symbol.
OK	Executes the command and closes the dialog box.
Cancel	Cancels the command and closes the dialog box.

Command File Command

`SYM(BOL) ADD symbol_nam address`

See Also

"To create a user-defined symbol" in the "Displaying Symbol Information" section of the "Debugging Programs" chapter.

User defined→Delete (ALT, -, U, D)

Deletes the specified user-defined symbol.

This command deletes the user-defined symbol selected in the Symbol window.

Command File Command

`SYM(BOL) DEL(ETE) symbol_nam`

See Also

"To delete a user-defined symbol" in the "Displaying Symbol Information" section of the "Debugging Programs" chapter.

User defined→Delete All (ALT, -, U, L)

Deletes all the user-defined symbols.

Command File Command

SYM(BOL) DEL(ETE) ALL

Trace Window Commands

This section describes the following commands:

- Display→Mixed Mode (ALT, -, D, M)
- Display→Source Only (ALT, -, D, S)
- Display→Bus Cycle Only (ALT, -, D, C)
- Display→Count→Absolute (ALT, -, D, C, A)
- Display→Count→Relative (ALT, -, D, C, R)
- Copy→Window (ALT, -, P, W)
- Copy→All (ALT, -, P, A)
- Search→Trigger (ALT, -, R, T)
- Search→State... (ALT, -, R, S)
- Trace Spec Copy→Specification (ALT, -, T, S)
- Trace Spec Copy→Destination... (ALT, -, T, D)

Display→Mixed Mode (ALT, -, D, M)

Chooses the source/mnemonic mixed display mode.

Command File Command

TRA(CE) DIS(PLAY) MIX(ED)

See Also

"To display source code mixed with assembly instructions" in the "Loading and Displaying Programs" section of the "Debugging Programs" chapter.

Display→Source Only (ALT, -, D, S)

Selects the source only display mode.

Command File Command

TRA(CE) DIS(PLAY) SOU(RCE)

See Also

"To display bus cycles" in the "Tracing Program Execution" section of the "Debugging Programs" chapter.

Display→Bus Cycle Only (ALT, -, D, C)

Selects the bus cycle only display mode.

Command File Command

TRA(CE) DIS(PLAY) BUS

See Also

To display bus cycles in the "Tracing Program Execution" section of the "Debugging Programs" chapter.

Display→Count→Absolute (ALT, -, D, C, A)

Selects the absolute mode (the total time elapsed since the trigger) for count information.

Command File Command

TRA(CE) DIS(PLAY) ABS(OLUTE)

See Also

"To display absolute or relative counts" in the "Tracing Program Execution" section of the "Debugging Programs" chapter.

Display→Count→Relative (ALT, -, D, C, R)

Selects the relative mode (the time interval between the current and previous cycle) for count information.

Command File Command

TRA(CE) DIS(PLAY) REL(ATIVE)

See Also

"To display absolute or relative counts" in the "Tracing Program Execution" section of the "Debugging Programs" chapter.

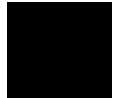

Copy→Window (ALT, -, P, W)

Copies the information currently in the Trace window to the specified listing file.

The listing file is specified with the File→Copy Destination... (ALT, F, P) command.

Command File Command

TRA(CE) COP(Y) DIS(PLAY)

See Also

"To copy window contents to the list file" in the "Working with Debugger Windows" section of the "Using the Debugger Interface" chapter.

Copy→All (ALT, -, P, A)

Copies all the trace information to the specified listing file.

The listing file is specified with the File→Copy Destination... (ALT, F, P) command.

Command File Command

TRA(CE) COP(Y) ALL

Search→Trigger (ALT, -, R, T)

Positions the trigger state at the top of the Trace window.

Command File Command

TRA(CE) FIN(D) TRI(GGER)

Search→State... (ALT, -, R, S)

Positions the specified state at the top of the Trace window.

Search Trace State Dialog Box

Choosing the Search→State... (ALT, -, R, S) command opens the following dialog box:

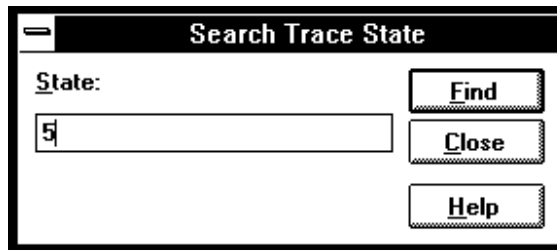

State Lets you enter the trace state number to search for.

Find Searches for the specified trace state.

Close Closes the dialog box.

Command File Command

TRA(CE) FIN(D) STA(TE) state_num

Trace Spec Copy→Specification (ALT, -, T, S)

Copies the current trace specification to the listing file.

Command File Command

TRA(CE) COP(Y) SPE(C)

Trace Spec Copy→Destination... (ALT, -, T, D)

Names the listing file to which debugger information may be copied.

This command opens a file selection dialog box from which you can select the listing file. Listing files have the extension ".LST".

Command File Command

COP(Y) TO filename

WatchPoint Window Commands

This section describes the following command:

Edit...

Edit... (ALT, -, E)

Registers or deletes watchpoints.

Variables can be selected from the another window (in other words, copied to the clipboard) before choosing the Edit... (ALT, -, E) command from the WatchPoint window's control menu, and they will automatically appear in the dialog box that is opened.

Dynamic variables can be registered and displayed in the WatchPoint window when the current program counter is in the function in which the variable is declared. If the current program counter is not in the function, the variable name is invalid and results in an error.

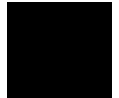

WatchPoint Dialog Box

Choosing the Edit... (ALT, -, E) command from the WatchPoint window's control menu opens the following dialog box:

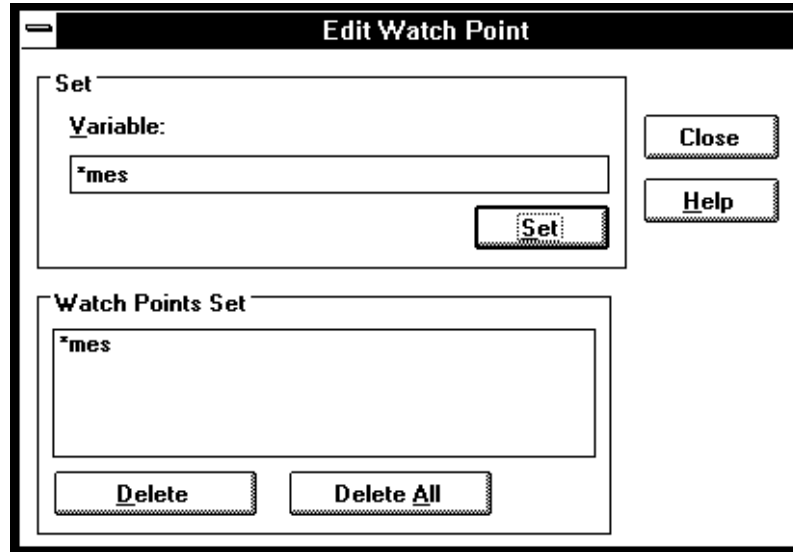

Variable	Lets you enter the name of the variable to be registered as a watchpoint. The contents of the clipboard, usually a variable selected from the another window, automatically appears in this text box.
Watch Points Set	Lists the current watchpoints and allows you to select the watchpoint to be deleted.
Set	Copies the specified variable to the WatchPoint window.
Delete	Deletes the variable selected in the Watch Points Set box.
Delete All	Deletes all the watchpoints.
Close	Closes the dialog box.

Command File Command

`WP SET address`

Registers the specified address as a watchpoint.

`WP DEL(ETE) address`

Deletes the specified watchpoint.

`WP DEL(ETE) ALL`

Deletes all the current watchpoints.

See Also

"To monitor a variable in the WatchPoint window" in the "Displaying and Editing Variables" section of the "Debugging Programs" chapter.

"Symbols" in the "Expressions in Commands" chapter.

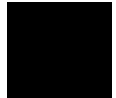

10



Window Pop-Up Commands

Window Pop-Up Commands

This chapter describes the commands that can be chosen from the pop-up menus in debugger windows. Pop-Up menus are accessed by clicking the right mouse button in the window.

- BackTrace Window Pop-Up Commands
- Source Window Pop-Up Commands

BackTrace Window Pop-Up Commands

- Source at Stack Level

Source at Stack Level

For the cursor-selected function in the BackTrace window, this command displays the function call in the Source window.



Source Window Pop-Up Commands

- Set Breakpoint
- Clear Breakpoint
- Evaluate It
- Add to Watch
- Run to Cursor

Set Breakpoint

Sets a breakpoint on the line containing the cursor. Refer to the Breakpoint→Set at Cursor (ALT, B, S) command.

Clear Breakpoint

Deletes the breakpoint on the line containing the cursor. Refer to the Breakpoint→Delete at Cursor (ALT, B, D) command.

Evaluate It

Evaluates the clipboard contents and places the result in the Expression window. Refer to the Evaluate... (ALT, -, E) command available from the Expression window's control menu.

Add to Watch

Adds the selected variable (that is, the variable copied to the clipboard) to the WatchPoint window. Refer to the Variable→Edit... (ALT, V, E) command.

Run to Cursor

Executes the program up to the Source window line containing the cursor. Refer to the Execution→Run to Cursor (ALT, R C) command.



Other Command File and Macro
Commands

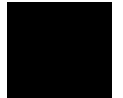

Other Command File and Macro Commands

This chapter describes the commands that are only available in command files, break macros, or buttons.

- BEEP
- EXIT
- FILE CHAINCMD
- FILE RERUN
- NOP
- TERMCOM
- WAIT

BEEP

Sounds beep during command file or break macro execution.

Command File Command

BEEP

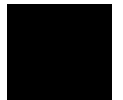

EXIT

Exits, or conditionally exits, command file execution.

Command File Command

EXIT

Exits command file execution.

EXIT VAR(IABLE) address value

Exits command file execution if the variable contains the value.

EXIT REG(ISTER) regname value

Exits command file execution if the register contains the value.

EXIT MEM(ORY) BYTE/WORD/LONG address value

Exits command file execution if the memory location contains the value.

EXIT IO BYTE/WORD address value

Exits command file execution if the I/O location contains the value.

FILE CHAINCMD

Chains command file execution.

This command lets you run one command file from another nonrecursively; in other words, control is not returned to the original command file.

By contrast, the FILE COMMAND command is recursive; if you use the FILE COMMAND command to run one command file from another, control will be returned to the original command file. FILE COMMAND commands can be nested four levels deep.

Command File Command

`FILE CHAINCMD filename`

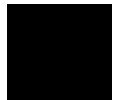

FILE RERUN

Starts command file execution over again.

This command is useful for looping stimulus files or running a demo or other command file continuously.

Command File Command

`FILE RERUN`

NOP

No operation.

This command may be used to prefix comment lines in command files.

Command File Command

NOP

NOP comments

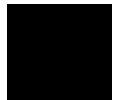

TERMCOM

Sends Terminal Interface commands to the HP 64700.

The HP 64700 Card Cage contains a low-level Terminal Interface, which allows you to control the emulator's functions directly. You can use the TERMCOM command to bypass the RTC Interface and send commands directly to the low-level Terminal Interface.

There is no window in the RTC Interface where you can execute TERMCOM commands directly. The only way to execute them with the RTC Interface is to make them part of a command file and then run the command file from an RTC Interface window.

You may need to start a unique target system that requires emulator intervention that is only available through the Terminal Interface. You can create the command file and then execute it at the appropriate time using a command such as File→Run Cmd File..., and place the name of your command file in the Run Command File dialog box.

The danger in using Terminal Interface commands via the TERMCOM command is that the RTC Interface may not be updated to know the state of the emulator. Some Terminal Interface commands can be executed by using the TERMCOM command, and the RTC Interface will not know that they were executed. Other Terminal Interface commands can be executed and the RTC Interface will be updated immediately. For example:

- If you have a command in your command file that changes the setting of RealTime→Monitor Intrusion→Disallowed/Allowed, (such as, TERMCOM "cf rrt=en"), the RTC Interface will not know about this change and will continue to try to operate according to the earlier setting. In this case, the RTC Interface may try to update its displays when the emulator is set to deny monitor access to the registers and memory.
- If you have a command in your command file that writes a value to memory (such as, TERMCOM "00000.00ff=0"), the Memory window will be updated immediately to show the new value, assuming you have chosen RealTime→Monitor Intrusion→Allowed.

Do not use the following Terminal Interface commands with the RTC
TERMCOM command:

- **stty, po, xp:** These commands will change the operation of the communications channel, and are likely to hang the RTC Interface.
- **echo, mac:** These commands may confuse the communications protocols in use in the channel.
- **wait:** The pod will enter a wait state, blocking access by the RTC Interface.
- **init, pv:** These will reset the emulator and end your session.
- **t:** This will confuse the functions of trace status polling and unload.

Refer to your "Terminal Interface User's Guide" for more information about Terminal Interface commands.

Command File Command

TERMCOM "ti-command"

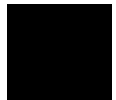

WAIT

Inserts wait delays during command file execution.

Command File Command

WAI (T) MON (I TOR)
Waits until MONITOR status.

WAI (T) RUN
Waits until RUN status.

WAI (T) UNK (N OWN)
Waits until UNKNOWN status.

WAI (T) SLO (W)
Waits until SLOW CLOCK status.

WAI (T) TGT (RESET)
Waits until TARGET RESET status.

WAI (T) SLE (EP)
Waits until SLEEP status.

WAI (T) GRA (NT)
Waits until BUS GRANT status

WAI (T) NOB (US)
Waits until NOBUS status.

WAI (T) TCO (M)
Waits until the trace is complete.

WAI (T) THA (LT)
Wait until the trace is halted.

WAI (T) TIM (E) *seconds*
Waits for a number of seconds.

12

Error Messages



Error Messages

This chapter helps you find details about the following error messages:

- Bad RS-232 port name
- Bad RS-422 card I/O address
- Could not open initialization file
- Could not write Memory
- EMIPLCR value is not consistent with VCCSYN/MODCLK
- Error occurred while processing Object file
- General RS-232 communications error
- General RS-422 communications error
- HP 64700 locked by another user
- HP 64700 not responding
- Incorrect DLL version
- Incorrect LAN Address (HP-ARPA, Windows for Workgroups)
- Incorrect LAN Address (Novell)
- Incorrect LAN Address (WINSOCK)
- Internal error in communications driver
- Internal error in Windows
- Interrupt execution (during run to caller)
- Interrupt execution (during step)
- Interrupt execution (during step over)
- Invalid transport name
- LAN buffer pool exhausted
- LAN communications error
- LAN MAXSENDSIZE is too small
- LAN Socket error
- Object file format ERROR
- Out of DOS Memory for LAN buffer
- Out of Windows timer resources
- PC is out of RAM memory
- Timed out during communications

Refer to the end of Chapter 4 for further discussions of specific error conditions.

Bad RS-232 port name

RS-232 port names must be of the form "COM<number>" where <number> is a decimal number from 1 to the number of communications ports within your PC.

Bad RS-422 card I/O address

The RS-422 card's I/O address must be a hexadecimal number from 100H through 3F8H whose last digit is 0 or 8 (example 100, 108, 110). Select an I/O address that does not conflict with the other cards in your PC.

Could not open initialization file

The initialization file was not found in the same directory where the executable file was found.

For example, if the application file is b3638.EXE, the initialization file b3638.INI is expected to be found in the same directory.

To fix this problem, you may be able to find the initialization file and move it to the same directory as the executable file, or you can create a new initialization file from the default initialization file. For example:

```
COPY b3638DEF.INI Bxxxx.INI
```

Note that the above command is the DOS COPY command. Do not use the ksh 'cp b3638DEF.INI Bxxxx.INI' command. Use only the DOS 'COPY b3638DEF.INI b3638.INI' command.

If you cannot find the default initialization file either, you can re-install the debugger software.

For correct operation, make certain the b3638.INI file has both read and write permission.

Could not write Memory

You may see this error message when trying to load a file or perform any other task that requires use of the monitor. The emulation monitor is used to load files, which requires writing to memory. If you have chosen RealTime→Monitor Intrusion→Disallowed the monitor will not be usable, and Execution→Reset may prevent use of the monitor in some emulators.

Choose RealTime→Monitor Intrusion→Allowed, and Execution→Break to ensure that the emulation monitor is running. The Status window should show Emulator: RUNNING IN MONITOR.

With this setup, the emulator should be able to write to Memory.

If you are still unable to load a file, select "Symbols Only" in the Load Object File dialog box and try to load the file. If Symbols Only will not load, the problem is in your symbols.

Choose "Data Only" in the Load Object File dialog box and try to load the file. If the symbols loaded, but the data fails to load, the problem is in your program code.

Call your local HP representative.

EMIPLCR value is not consistent with VCCSYN/MODCLK

This means you are running the emulator with a crystal and the EMIPLCR (emulator's copy of clock control register, IPLCR) needs to be reconfigured. It has provided a system clock frequency outside the frequency specification (10 MHz to 25 MHz when using a crystal).

To see the results of this error condition, open the Configuration Information window in the RTC interface. The last two lines on the display show the present multiplication factor (MF+1), and the resulting system clock frequency.

The Multiplication Factor bits (MF11-0 of EMIPLCR) select the multiplication factor applied to your target system clock (EXTAL). You can select any multiplication factor from 1 (MF11-0 = 000h) to 4096 (MF11-0 = FFFh). You must select a multiplication factor for your EXTAL that results in a system frequency of 10 MHz to 25 MHz.

Open the System Registers window and select a new value for IPLCR that provides the required multiplication factor in bits MF11-MF0.

Any time a new value is written into the MF11-MF0 bits, the IMP PLL will lose the lock condition for 2500 EXTAL clocks. During the non-locked period, all clocks generated by the IMP PLL will be disabled. Then the IMP PLL will relock.

Example:

In the following example, the value of MF11-0 is 000h and the emulator is using a 32.768 kHz clock crystal. The emulator generates the message, "EMIPLCR value is not consistent with VCCSYN/MODCLK."

By choosing Settings→Emulator Config→Information..., you see:

The clock configuration is set for internal clock
The emulator clock header is set for 32.768 KHz crystal
CLKO Drive mode is full strength
IMP PLL is enabled
Multiplication Factor (MF+1) is 1
Frequency is 0 MHz - Slow Clock



EMIPLCR value is not consistent with VCCSYN/MODCLK

You open the System Registers window and write the value 190h to register IPLCR. This sets MF11-0 for a multiplication factor of 401 (MF11-0 = 400, plus the constant 1). This gives a system clock frequency of 13.140 MHz, which is within the 10 MHz to 25 MHz system clock frequency range.

The clock configuration is set for internal clock
The emulator clock header is set for 32.768 KHz crystal
CLKO Drive mode is full strength
IMP PLL is enabled
Multiplication Factor (MF+1) is 401
Frequency is 13.140 MHz

Error occurred while processing Object file

The following is a list of typical reasons why an error might occur while processing an object file. There are many other possible reasons.

- Bad record in the object file.
- File is in wrong format.
- File does not follow OMF Specifications correctly.
- No memory mapped.
- Attempt to write to guarded memory.
- Emulator restricted to real-time runs. Enter the command, "RealTime→Monitor Intrusion→Allowed".
- Emulator not executing the monitor. Enter the command, "Execution→Break".

Another message often occurs along with this message. View the help information for the other message, if available.

Call your local HP representative.

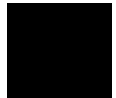

General RS-232 communications error

In general, these messages indicate that the RS-232 communication has intermittent errors. Sometimes you will get this message if you power on the emulator, or when you try to connect to the emulator. In that case, simply retry the connection (by double-clicking on the RS232C driver line in the selection box); if you connect with no problems the second time, you can ignore the original message.

If you get this message other than during connection, you can try to fix the problem by:

- Reducing the length of the RS-232 cable between the PC and the HP 64700.
- Reducing the number of tasks running under Windows.
- Reducing the baud rate (the default is 19200).

For further information, refer to the paragraph titled, "If you have RS-232 connection problems" in the Communications Help screen, or in Chapter 15, "Installing the Debugger" in the Real-Time C Debugger User's Guide.

General RS-422 communications error

In general, these messages indicate that the RS-422 communication has intermittent errors. Sometimes you will get this message if you power on the emulator, or when you try to connect to the emulator. In that case, simply retry the connection (by double-clicking on the HP-RS422 driver line in the selection box); if you connect with no problems the second time, you can ignore the original message.

If you get this message other than during connection, you can try to fix the problem by:

- Reducing the number of tasks running under Windows.
- Reducing the baud rate (the default is 230400).

HP 64700 locked by another user

Because it is possible to destroy another user's measurement by choosing the Unlock button in the error dialog box, check with the other user before unlocking the HP 64700.

Note that if the other user is actually using an interface to the HP 64700, an Unlock request will fail.

HP 64700 not responding

The HP 64700 has not responded within the timeout period. There are several possible causes of this error. For example, a character could have dropped during RS-232 communications, or some network problem could have disrupted communications.

Usually, you must cycle power to the HP 64700 to fix this problem.

See also: The description for the error message titled, "Timed out during communications."

Incorrect DLL version

The version of the dynamic link libraries (.DLLs) used by the Real-Time C Debugger does not match the version of the main program (.EXE).

If you have two versions of the debugger on your system, you may see this message when you try to execute both of them at the same time, or when you execute one version and then the other without restarting Windows. Once DLLs have been loaded into Windows memory, they stay there until you exit Windows. Therefore, exit windows, restart windows, and try again.

This message will also appear if you have somehow loaded a version of the DLLs that is different from the version of the executable. In this case, you must reload your software.

Incorrect LAN Address (HP-ARPA, Windows for Workgroups)

A LAN address can be one of two types: an IP address, or a host name.

An IP address consists of four digits separated by dots. Example:

```
15.6.28.0
```

A hostname is a name that is related (mapped) to an IP address by a database. For example, the file \LANMAN.DOS\ETC\HOSTS (HP-ARPA) or \WINDOWS\HOSTS (Windows for Workgroups) may contain entries of the form:

```
system1 15.6.28.0
```

Note

The directory of the "hosts" file may be different on your system.

If "HP Probe" or "DNR" (Domain Name Resolution) is available on your PC, those are consulted first for a mapping between the hostname and the IP address. If the hostname is not found by that method, or if those services are unavailable, the local "hosts" file is consulted for the mapping.

Note that if "Probe" is available on your system but unable to resolve the address, there will be a delay of about 15-seconds while Probe is attempting to find the name on the network.

Incorrect LAN Address (Novell)

A LAN address can be one of two types: an IP address, or a host name.

An IP address consists of four digits separated by dots. Example:

```
15.6.28.0
```

A hostname is a name that is related (mapped) to an IP address by a database. For example, the file \NET\TCP\HOSTS may contain entries of the form:

```
system1 15.6.28.0
```

Note

The directory of the "hosts" file may be different on your system. Also, all files defined by the PATH TCP_CFG setting under "Protocol TCPIP" in the NET.CFG files are searched.

Incorrect LAN Address (WINSOCK)

A LAN address can be one of two types: an IP address, or a host name.

An IP address consists of four digits separated by dots. Example:

```
15.6.28.0
```

A hostname is a name that is related (mapped) to an IP address by a database. For example, the hosts file may contain entries of the form:

```
system1 15.6.28.0
```

Note

Because WINSOCK is a standard interface to many LAN software vendors, you need to read your LAN vendor's documentation before specifying the LAN address.

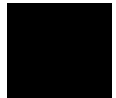

Internal error in communications driver

These types of errors typically occur because other applications have used up a limited amount of some kind of global resource (such as memory or sockets).

You usually have to reboot the PC to free the global resources used by the communications driver.

Internal error in Windows

These types of errors typically occur because other applications have used up a limited supply of some kind of global resource (such as memory, sockets, tasks, or handles).

You usually have to reboot the PC to free the global resources used by Windows.

Interrupt execution (during run to caller)

The Return dialog box appears when running to the caller of a function and the caller is not found within the number of milliseconds specified by StepTimerLen in the .INI file of the debugger application.

You can cancel the run to caller command by choosing the STOP button, which causes program execution to stop, the breakpoint to be deleted, and the processor to transfer to the RUNNING IN USER PROGRAM status.

Interrupt execution (during step)

The Step dialog box appears when stepping a source line or assembly instruction and the source line or instruction does not execute within the number of milliseconds specified by StepTimerLen in the .INI file of the debugger application.

You can cancel the step command by choosing the STOP button, which causes program execution to stop, the breakpoint to be deleted, and the processor to transfer to the RUNNING IN USER PROGRAM status.

Interrupt execution (during step over)

The Step dialog box appears when stepping over a function or subroutine and the function or subroutine does not execute within the number of milliseconds specified by StepTimerLen in the .INI file of the debugger application.

You can cancel the step-over command by choosing the STOP button, which causes program execution to stop, the breakpoint to be deleted, and the processor to transfer to the RUNNING IN USER PROGRAM status.

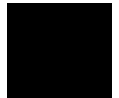

Invalid transport name

The transport name chosen does not match any of the possible transport names (RS232C, HP-ARPA, Novell-WP, WINSOCK1.1, W4WG-TCP, or HP-RS422).

The transport name can be specified either on the command line with the `-t` option or in the `.INI` file:

```
[Port]
Transport=<transport name>
```

Choosing an appropriate transport in the dialog box that follows this error message will correct the entry in the `.INI` file, but if the error is in the command line option, you must modify the command line (by using the "Properties..." command in the Program Manager).

LAN buffer pool exhausted

The LAN buffer pool is used as a temporary buffer between the time the debugger sends data and the time the LAN actually sends it. When this pool is exhausted, the debugger cannot send any data across the LAN.

The size of the sockets buffer pool is configured in the network installation procedure. The size and number of LAN buffer pools can be changed by editing your network configuration file.

LAN communications error

This message may appear after any kind of LAN error.

Refer to the documentation for your LAN software for descriptions of the types of problems that can cause LAN errors.

LAN MAXSENDSIZE is too small

This message indicates you have configured your LAN with a value or MAXSENDSIZE that is less than 100 bytes. Note that the default is 1024 bytes.

The Real-Time C Debugger requires at least 100 bytes for this parameter.

To fix this, change the following entry in your PROTOCOL.INI file and reboot your PC:

```
[SOCKETS]  
MAXSENDSIZE
```

LAN socket error

A TCP-level error has occurred on the network. See your network administrator.

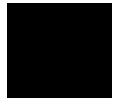

Object file format ERROR

This message is typically caused by one of two conditions:

- Bad format file. Perhaps there is a bad record within the file. If you have a file format verifier, submit your file to it to determine whether or not all records are in the correct format.
- Unknown construct. Perhaps the construct of your file is unfamiliar to the reader.

To respond to this error message, verify the file format, and ensure that the reader can understand the file format in use.

If these steps do not solve the problem, call your local HP representative.

Out of DOS Memory for LAN buffer

This means that there is not enough memory in the lower 1 Mbyte of address space (that is, conventional memory) for the LAN driver to allocate a buffer to communicate with the LAN TSR.

When you are in windows, and execute the DOS command "mem", you cannot see the memory that is in the lower 1 Mbyte that is used by the windows program. If you have the Microsoft program "heapwalker", you can use it to see what programs have allocated space in the address range 0 through FFFFF.

To fix this, you can:

- Reduce the number of TSRs running on your PC (before Windows starts) that use conventional memory.
- Reconfigure your network to have fewer sockets or modules loaded, or to be configured for fewer total connections.
- Use a different memory manager to reduce your network memory usage, such as QEMM.

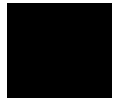

Out of Windows timer resources

The debugger is not able to acquire the timer resources it needs.

There are a limited number of timer resources in Windows. You may be able to free timer resources by closing other applications.

PC is out of RAM memory

The debugger is not able to acquire the memory it needs because other applications are using it, or because of fragmented memory.

You may be able to free memory by closing other applications, or you might have to reboot the PC to cause memory to be unfragmented.

Timed out during communications

The HP 64700 has not responded within the timeout period. There are various causes for this error. For example, a character could have been dropped during RS-232 communications or some network problem could have disrupted communications.

The timeout period for reading and writing to the HP 64700 is defined by TimeoutSeconds in either the [RS232C], [HP-ARPA], [Novell-WP], or [HP-RS422] section of the b3638.INI file. For example, if you are using the RS-232C transport:

```
[RS232C]  
TimeoutSeconds=<seconds>
```

The number of seconds can be between 1 and 32767. The default is 20 seconds.

If you are using RS-232C or RS-422 transport ...

The TimeoutSeconds value is also used for connecting to the HP 64700 (as well as for reading and writing).

If you are using HP-ARPA or Novell-WP transport ...

If there are several gateways or bridges between the PC and the emulator, larger values of TimeoutSeconds may be reasonable.

The timeout period for connecting to the HP 64700 is defined in the PROTOCOL.INI file.

```
[TCP_IP_XFR]  
TCPCONNTIMEOUT=<seconds>
```

The default connection timeout is 30 seconds.

The remainder of this discussion shows you how to overcome the problem of "connection timed out" during large memory fill operations.

The RTC interface sends the memory fill operation to the emulator as a single command. While the command is executing in the emulator, the emulator cannot respond to inquiries from the interface about its status. If the memory fill takes long enough, the connection will time out.

Emulators for some microprocessors take up to one minute per megabyte to perform a memory fill operation. Timeout default values for RTC interfaces shipped from HP are typically 45 seconds.

First Workaround. Modify the TimeoutSeconds field (discussed above) to increase the TimeoutSeconds value. Then exit the interface and restart it (to ensure that the new value of TimeoutSeconds is read). You may experiment with several values of TimeoutSeconds to find the value that allows you to do a memory fill. The problem with this workaround is that all timeouts will take this new longer time, and you may find this annoying when you are not doing memory fill operations.

Second Workaround. Create a command file that contains TERMCOM commands to write to small portions of the overall memory to be filled. For example, suppose the following Memory window command causes the emulator to time out, "Memory→Utilities→Fill→0 to ffff".

You might make a command file named memfill.cmd, and place the following commands in it:

```
TERMCOM "m 0000..00fff=0"  
TERMCOM "m 0100..01fff=0"  
TERMCOM "m 0200..02fff=0"  
TERMCOM "m 0300..03fff=0"  
TERMCOM "m 0400..04fff=0"  
TERMCOM "m 0500..05fff=0"  
TERMCOM "m 0600..06fff=0"  
TERMCOM "m 0700..07fff=0"  
TERMCOM "m 0800..08fff=0"  
TERMCOM "m 0900..09fff=0"  
TERMCOM "m 0a00..0afff=0"  
TERMCOM "m 0b00..0bfff=0"  
TERMCOM "m 0c00..0cfff=0"  
TERMCOM "m 0d00..0dfff=0"  
TERMCOM "m 0e00..0efff=0"  
TERMCOM "m 0f00..0ffff=0"
```

When you choose File→Run Cmd File→... and select your memfill.cmd file, it will not exceed the timeout value. This is because the emulator will be able to respond to inquiries from the interface between execution of each of the TERMCOM commands in your command file.

Part 4

Concept Guide

Topics that explain concepts and apply them to advanced tasks.

Part 4

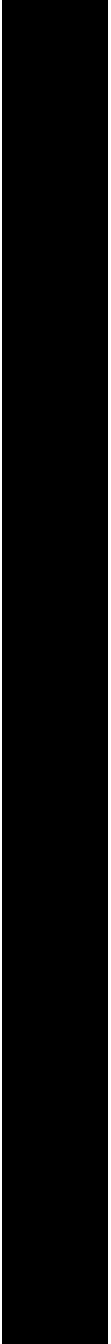

13

Concepts

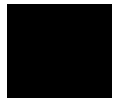

Concepts

This chapter describes the following topics.

- Debugger Windows
- Compiler/Assembler Specifications
- Trace Signals and Predefined Status Values

Debugger Windows

This section describes the following debugger windows:

- BackTrace
- Button
- Device Regs
- Expression
- I/O
- Memory
- Register
- Source
- Status
- Symbol
- Trace
- WatchPoint

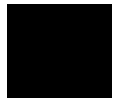

The BackTrace Window

The BackTrace window displays the function associated with the current program counter value and this function's caller functions in backward order. Applicable addresses are prefixed with module#linenum information. The current arguments of these functions are also displayed.

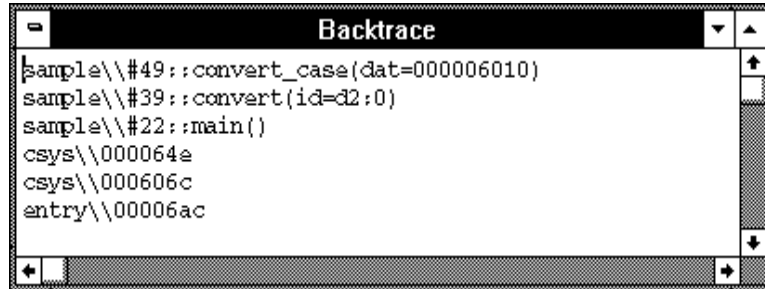

The BackTrace window is updated when program execution stops at an occurrence of breakpoint, break, or Step command.

The BackTrace window lets you copy text strings, to the clipboard by double-clicking words or by holding down the left mouse button and dragging the mouse pointer.

By clicking the right mouse button in the BackTrace window, you can access the Source at Stack Level popup menu command. Cursor-select a function in the BackTrace window and choose this command to display (in the Source window) the code that called the function.

See Also

"BackTrace Window Pop-Up Commands" in the "Window Pop-Up Commands" chapter.

The Button Window

The Button window contains user-defined buttons that, when chosen, execute debugger commands or command files.



The Button window's *control menu* provides the Edit... (ALT, -, E) command which lets you add and delete buttons from the window.

See Also

"Using Command Files" in the "Using the Debugger Interface" chapter.

"Button Window Commands" in the "Window Control Menu Commands" chapter.

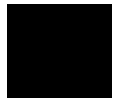

Device Regs Window

The Device Regs window shows all of the internal registers that are used to control various devices. Each register is represented by a row which holds a mnemonic name, a current value, and a description of the register contents.

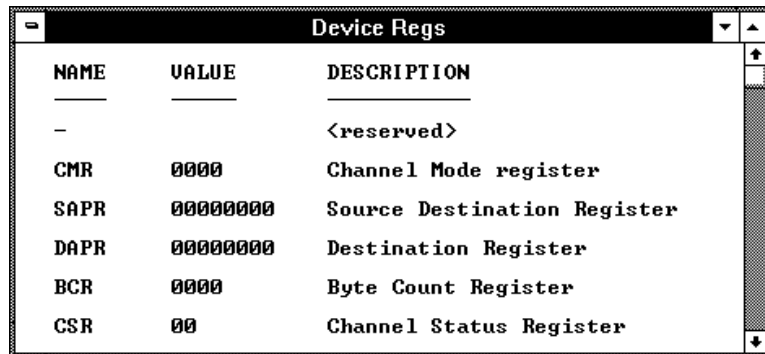

The screenshot shows a window titled "Device Regs" with a table of registers. The table has three columns: NAME, VALUE, and DESCRIPTION. The registers listed are: <reserved>, CMR (Channel Mode register), SAPR (Source Destination Register), DAPR (Destination Register), BCR (Byte Count Register), and CSR (Channel Status Register).

NAME	VALUE	DESCRIPTION
-		<reserved>
CMR	0000	Channel Mode register
SAPR	00000000	Source Destination Register
DAPR	00000000	Destination Register
BCR	0000	Byte Count Register
CSR	00	Channel Status Register

The registers may be edited by either single clicking or double-clicking on the value. A single click puts you in a mode where the left or right arrow keys may be used for placement of the cursor. Double-clicking puts you in one of two modes; either a Register Bit Fields dialog pops up or the value is highlighted. When the value is highlighted, the backspace key will erase the value and a completely new value may be entered. This mode is applicable to registers where the value is considered a single number and is not divided by any bit-fields.

See Also

"Device Regs Window Commands" in the "Window Control Menu Commands" chapter.

Device Register Dialogs

When a register has bit-fields, a dialog will pop-up and the register value may be edited by changing the whole value or by editing individual bit-fields.

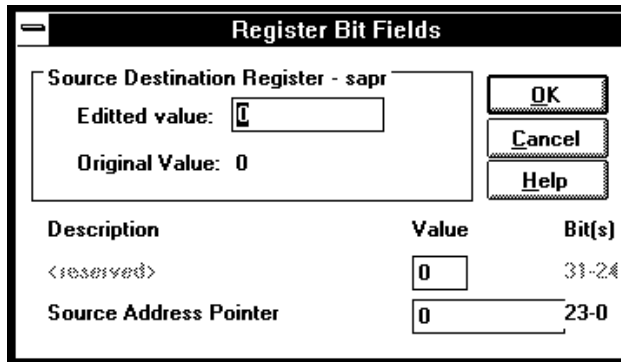

When editing in the dialog box, a carriage-return is the same as choosing the OK button. To end an edit of a field within the dialog box without quitting, use the Tab key.

- Edited Value Shows the register value that corresponds to the selections made below. You can also change the register's value by modifying the value in this text box.
- Original Value Shows the value of the register when the dialog box was opened. If the register could not be read, 'XXXXXXXX' is displayed.
- OK Modifies the register as specified, and closes the dialog box.
- Cancel Closes the dialog box without modifying the register.

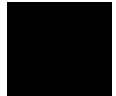

The Expression Window

The Expression window displays the results of the EVALUATE commands in command files or break macros.

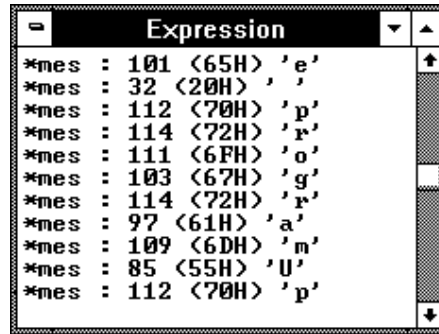

When a variable name is specified with the EVALUATE command, the Expression window displays the evaluation of the variable. When a quoted string of ASCII characters is specified with the EVALUATE command, the Expression window displays the string.

The Expression window's *control menu* provides the Evaluate... (ALT, -, E) command which lets you evaluate expressions and see the results in the window.

See Also

"Expression Window Commands" in the "Window Control Menu Commands" chapter.

The I/O Window

The I/O window displays the contents of the I/O locations.

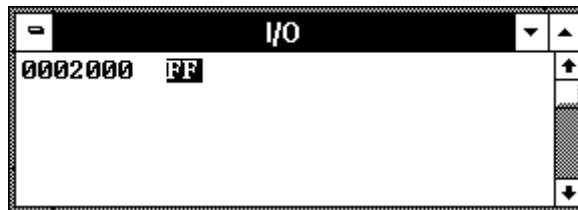

You can modify the contents of I/O locations by double-clicking on the value, using the keyboard to type in the new value, and pressing the Enter key.

The I/O window contents are updated periodically when the processor is running the user program.

If a location is in target system memory, a temporary break from the user program into the monitor program must occur in order for the debugger to update or modify that location's contents. If it's important that the user program execute without these types of interruptions, you should disallow monitor intrusion. Even when monitor intrusion is allowed, you can stop temporary breaks during the window update by turning polling OFF.

See Also

"Displaying and Editing I/O Locations" in the "Debugging Programs" chapter.

"I/O Window Commands" in the "Window Control Menu Commands" chapter.

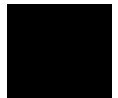

The Memory Window

The Memory window displays memory contents.

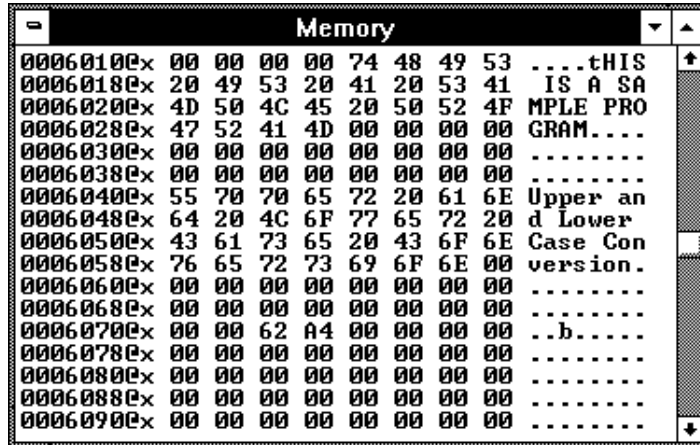

The Memory window has *control menu* commands that let you change the format of the memory display and the size of the locations displayed or modified. When the absolute (single-column) format is chosen, symbols corresponding to addresses are displayed. When data is displayed in byte format, ASCII characters for the byte values are also displayed.

When Memory window polling is turned ON, you can modify the addresses displayed or contents of memory locations by double-clicking on the address or value, using the keyboard to type in the new address or value, and pressing the Enter key.

The Memory window contents are updated periodically when the processor is running the user program.

If a location is in target system memory, a temporary break from the user program into the monitor program must occur in order for the debugger to update or modify that location's contents. If it's important that the user program execute without these types of interruptions, you should disallow monitor intrusion. Even when monitor intrusion is allowed, you can stop temporary breaks during the window update by turning polling OFF.

See Also

"Displaying and Editing Memory" in the "Debugging Programs" chapter.

"Memory Window Commands" in the "Window Control Menu Commands" chapter.

The Register Window

The Register window displays contents of registers.

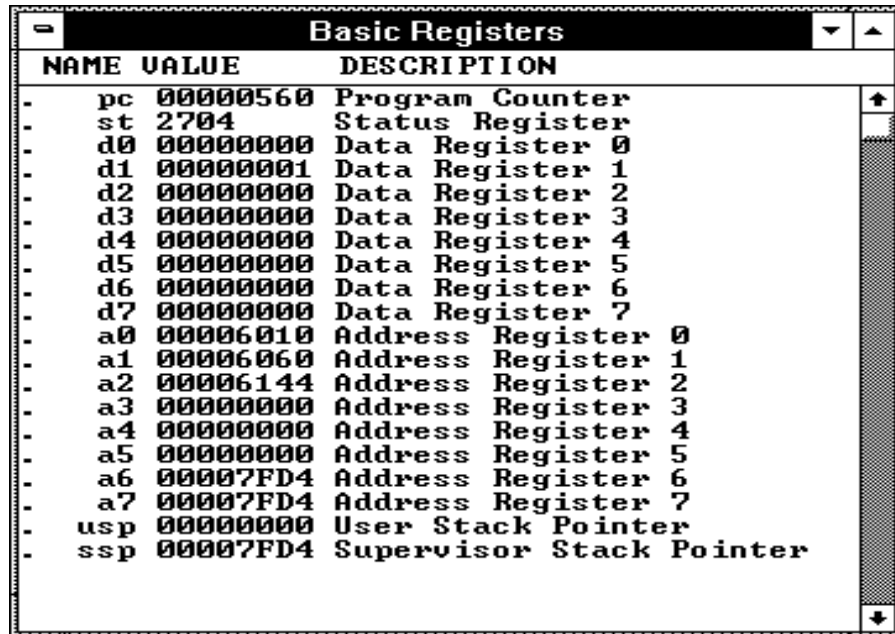

You can modify register contents by double-clicking on the register value, using the keyboard to type in the new value, and pressing the Enter key. When you double-click on the Status Register (st) in the Basic Registers window, a dialog box opens and allows you to set or clear individual bits. The

same occurs when you open any other register window and click on a register whose bits can be modified individually.

The Register window contents are updated periodically when the processor is running the user program and monitor intrusion is allowed.

A temporary break from the user program into the monitor program must occur in order for the debugger to update or modify register contents. If it's important that the user program execute without these types of interruptions, you should disallow monitor intrusion.

See Also

"Displaying and Editing Registers" in the "Debugging Programs" chapter.

"Register Window Commands" in the "Window Control Menu Commands" chapter.

The Source Window

The Source window displays source files, optionally with disassembled instructions intermixed.

The Source window contains a cursor whose position is used when setting or deleting breakpoints or break macros or when running the program up to a certain line.

The Source window lets you copy strings, usually variable or function names to be used in commands, to the clipboard by double-clicking words or by holding down the left mouse button and dragging the mouse pointer.

The Source window also provides commands in the *control menu* that let you select whether disassembled instruction mnemonics should appear intermixed with the C source code.

By clicking the right mouse button in the Source window, you can also access pop-up menu commands.

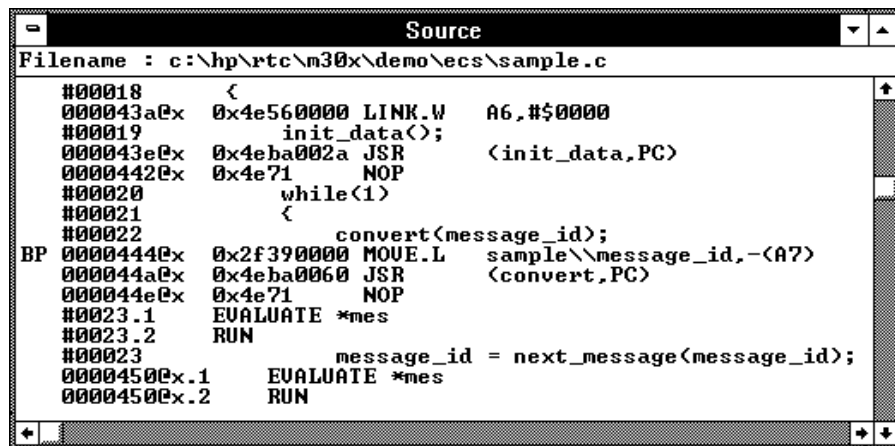

```
Source
Filename : c:\hp\rtc\m30x\demo\ecs\sample.c
#00018      <
000043a0x  0x4e560000 LINK.W   A6, #0000
#00019      init_data();
000043e0x  0x4eba002a JSR     <init_data,PC>
00004420x  0x4e71    NOP
#00020      while(1)
#00021      {
#00022      convert(message_id);
BP 00004440x  0x2f390000 MOV.L   sample\message_id,-(A7)
000044a0x  0x4eba0060 JSR     <convert,PC>
000044e0x  0x4e71    NOP
#0023.1    EVALUATE *mes
#0023.2    RUN
#00023      message_id = next_message(message_id);
00004500x.1  EVALUATE *mes
00004500x.2  RUN
```

Chapter 13: Concepts
Debugger Windows

Filename	The name of the displayed source file appears at the top of the window.
Source Lines	<p>C source code is displayed when available. Source lines are preceded by the corresponding line numbers.</p> <p>When programs are written in assembly language or when no C source code is available, disassembled instruction mnemonics are displayed.</p> <p>The interface will only support display in either trace or source windows of source lines numbered less than 32,000.</p>
Disassembled Instructions	<p>In the Mnemonic Display mode, disassembled instruction mnemonics are intermixed with the source lines. Disassembled lines contain address, data, and mnemonic information.</p> <p>When symbolic information is available for the address, the corresponding symbol line precedes the disassembled instruction, displayed in the <code>module_name\symbol_name</code> format.</p>
Current PC	The line associated with the current program counter is highlighted.
Scroll Bars	For C source files, the display scrolls within the source files. For assembly language programs or programs for which no source code is available, the display scrolls for all the memory space.
"BP" Marker	The breakpoint marker, "BP", appears at the beginning of the breakpoint lines or break macro lines.
Break Macro Lines	Decimal points following line numbers or addresses indicate break macro lines.

Note

When programs are stored in target system memory and the emulator is running in real-time, source code cannot be displayed.

See Also

"Loading and Displaying Programs",
"Stepping, Running, and Stopping the Program", and
"Using Breakpoints and Break Macros" in the "Debugging Programs" chapter.

"Source Window Commands" in the "Window Control Menu Commands" chapter.

"Source Window Pop-Up Commands" in the "Window Pop-Up Commands" chapter.

"To set colors in the Source window" in the "Working with Debugger Windows" section of the "Using the Debugger Interface" chapter.

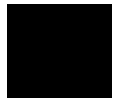

The Status Window

The Status window shows:

- Emulator status.
- Trace status.
- Scope of the current program counter value.
- Progress of symbols being loaded from a file.
- Last five asynchronous messages from the emulator.

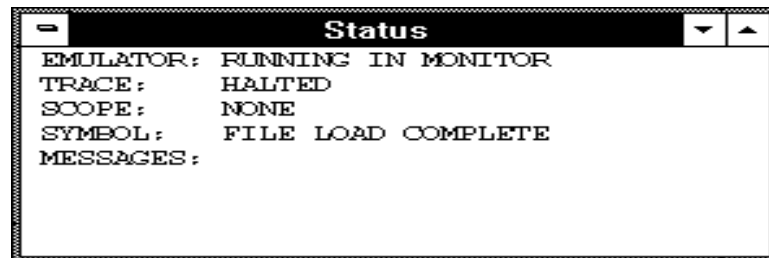

Emulation Processor Status Messages

EMULATION RESET

The emulation processor is being held in the reset state by the emulator.

RUNNING IN MONITOR

The emulation processor is executing the monitor program.

RUNNING IN USER PROGRAM

The emulation processor is executing the user program.

RUNNING REALTIME IN USER PROGRAM

The emulation processor is executing the user program in the real-time mode where:

- Any command that would temporarily interrupt user program execution is disabled.

- Any on-screen information that would be periodically updated by temporarily interrupting user program execution (target system memory or register contents, for example) is disabled.

WAITING FOR TARGET RESET

The emulation processor is waiting for a RESET signal from the target system. User program execution starts on reception of the RESET signal.

SLOW CLOCK

No proper clock pulse is supplied from the external clock.

EMULATION RESET BY TARGET

The emulation processor is being held in a reset state by a RESET signal from the target system.

BUS GRANT TO TARGET SYSTEM DEVICE

The bus is granted to some device in the target system.

NO BUS CYCLE

The bus cycle is too slow or no bus cycle is provided.

HALTED

The emulation processor has halted.

UNKNOWN STATE

The emulation processor is in an unknown state.

Other Emulator Status Messages

The Status window may also contain status messages other than the emulation processor status messages described above:

BREAK POINT HIT AT module_name#line_number

The breakpoint specified in the source code line was hit and program execution stopped at "line_number" in "module".

BREAKPOINT HIT AT address

The breakpoint specified in the assembled line was hit and program execution stopped at "address".

UNDEFINED BREAKPOINT at address

The breakpoint instruction occurred at "address", but it was not inserted by a breakpoint set command.

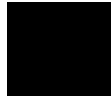

WRITE TO ROM BREAK

Program execution has stopped due to a write to location mapped as ROM. These types of breaks must be enabled in the emulator configuration.

ACCESS TO GUARD BREAK

Program execution has stopped due to a write to a location mapped as guarded memory.

TRACE TRIGGER BREAK

The analyzer trigger caused program execution to break into the monitor (as specified by selecting the Break On Trigger option in the trace setting dialog box).

Trace Status Messages

TRACE RUNNING

The trace has been started and trace memory has yet to be filled; this could be because the trigger condition has not occurred or, if the trigger condition has occurred, there have not been enough states matching the store condition to fill trace memory. Contents of the trace buffer cannot be displayed during the TRACE RUNNING status; you must halt the trace before you can display the contents of the trace buffer.

TRACE HALTED

The trace was halted before the trace buffer was filled. The status indicates that the trace was halted immediately after the emulator powerup, or that the trace was force-terminated by the user. In the TRACE HALTED status, the analyzer displays the contents of the trace buffer before the halt in the Trace window.

TRACE COMPLETE

The trace completed because the trace buffer is full. The results are displayed in the Trace window.

The Symbol Window

The Symbol window displays information on the following types of symbols:

- Modules
- Functions
- Global symbols
- Local symbols
- Global Assembler symbols
- Local Assembler symbols
- User-defined symbols

The Symbol window has *control menu* commands that let you display various types of symbols, add or delete user-defined symbols, copy Symbol window information, or search for symbols that contain a particular string.

The Symbol window lets you copy symbols to the clipboard by clicking the left mouse button. The symbol information can then be pasted from the clipboard in other commands.

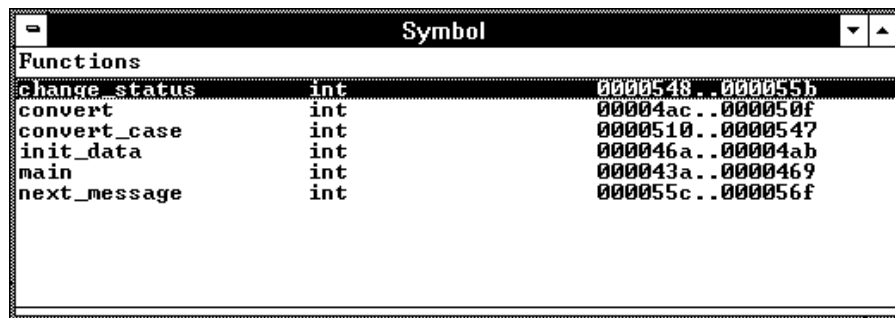

Symbols are displayed with "type" and "address" values where appropriate.

See Also

"Displaying Symbol Information" in the "Debugging Programs" chapter.

"Symbol Window Commands" in the "Window Control Menu Commands" chapter.

The Trace Window

The Trace window displays trace results and shows source code lines that correspond to the execution captured by the analyzer. Optionally, bus cycle states can be displayed along with the source code lines.

The Trace window has *control menu* commands that let you display bus cycles, specify whether count information should be absolute or relative, or copy information from the window.

The Trace window opens automatically when a trace is complete.

state	typ	module	#line	:function	source	
2	SEQ	sample	#0038	:convert	{	1.200 uS^TG
6	SEQ	sample	#0044	:convert_case	{	14.40 uS
12	SEQ	sample	#0054	:change_statu	{	232.4 uS
20	SEQ	sample	#0062	:next_message	{	27.60 uS
24	SEQ	sample	#0038	:convert	{	17.00 uS
28	SEQ	sample	#0044	:convert_case	{	14.40 uS
34	SEQ	sample	#0054	:change_statu	{	323.1 uS
42	SEQ	sample	#0062	:next_message	{	26.80 uS
46	SEQ	sample	#0038	:convert	{	16.20 uS
50	SEQ	sample	#0044	:convert_case	{	14.40 uS
56	SEQ	sample	#0054	:change_statu	{	254.0 uS
64	SEQ	sample	#0062	:next_message	{	26.80 uS
68	SEQ	sample	#0038	:convert	{	17.00 uS
72	SEQ	sample	#0044	:convert_case	{	14.40 uS

For each line in the Trace window, the trace buffer state number, the type of state, the module name and source file line number, the function name, the source line, and the time count information are displayed.

The << and >> buttons let you move between the multiple frames of trace data that are available with newer analyzers for the HP 64700.

The type of state can be a sequence level branch (SEQ), a state that satisfies the prestore condition (PRE), or a normal state that matches the store conditions (in which case the type field is empty).

Bus cycle states show the address and data values that have been captured as well as the disassembled instruction or status mnemonics.

On startup, the system defaults to the source only display mode, where only source code lines are displayed. The source/bus cycle mixed display mode

can be selected by using the Trace window control menu's Display→Mixed Mode (ALT, -, D, M) command. In the source/bus cycle mixed display mode, each source code line is immediately followed by the corresponding bus cycles.

The trace buffer stores bus cycles only. The system displays source lines in the Trace window based on execution bus cycles.

See Also

"Tracing Program Execution" and
"Setting Up Custom Trace Specifications" in the "Debugging Programs"
chapter.

"Trace Window Commands" in the "Window Control Menu Commands"
chapter.

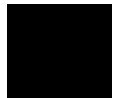

The WatchPoint Window

The WatchPoint window displays the contents of variables that have been registered with the Variable→Edit... (ALT, V, E) command or with the Edit... (ALT, -, E) command in the WatchPoint window's control menu.



The contents of dynamic variables are displayed only when the current program counter is in the function in which the variable is declared.

You can modify the contents of variables by double-clicking on the value, using the keyboard to type in the new value, and pressing the Enter key.

The WatchPoint window lets you copy text strings, to the clipboard by double-clicking words or by holding down the left mouse button and dragging the mouse pointer.

See Also

"Displaying and Editing Variables" in the "Debugging Programs" chapter.

"WatchPoint Window Commands" in the "Window Control Menu Commands" chapter.

Compiler/Assembler Specifications

This section describes:

- IEEE-695 Object Files
- Compiling Programs with MCC68K
- Compiling Programs with AxLS

IEEE-695 Object Files

This section addresses the IEEE-695 object files compiled or assembled with the following compilers and assemblers:

- Microtec MCC68K Compiler
- Microtec ASM68K Assembler
- HP AxLS Compiler
- HP AxLS Assembler

Assembly Language Source File Display

The IEEE-695 object files do not contain assembly language source file information. Instead, memory contents are disassembled.

Mnemonic Display

An assembly language instruction preceding or following a function entry point may have multiple corresponding source code lines. For this type of instruction, the Source window in the Mnemonic Display mode shows multiple corresponding disassembled lines having the same address.

Single-Stepping Loop Control Statements

The system may fail in single-stepping such loop control statements as "while", "for", or "do while" statement.

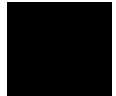

Pragma Statement and Debugger Display

When a "pragma" statement is used to describe an assembly language instruction in C source files, the source information is generated as follows in the IEEE-695 object files:

- A pragma instruction has a single line number.
- The address for the pragma instruction indicates the address for the first line of the instruction.
- The line number for the pragma instruction indicates the line number for the last line of the instruction.

This imposes the following display restriction on the Real-Time C Debugger:

The Source window in the Mnemonic Display mode shows lines in a pragma instruction all at one time as listed below.

```
#0010      #pragma asm
#0011          nop
#0012          nop
#0013      #pragma endasm
0001000    00      NOP
0001001    00      NOP
```

During single-stepping, the last line of the pragma instruction is highlighted while the program counter indicates the first line.

```
#0010      #pragma asm
#0011          nop
#0012          nop
#0013      #pragma endasm
```

Program counter indicating line 11

Highlighted line 12

Only the last line of the pragma instruction is displayed in the trace results.

Compiling Programs with MCC68K

- 1 Compile the source files with the `mcc68k` command.
- 2 Assemble the source files with the `asm68k` command.
- 3 Link the object files with the `lnk68k` command.

Required Compiler/Assembler/Linker

Compiler	Microtec MCC68K Compiler
Assembler	Microtec ASM68K Assembler
Linker	Microtec LNK68K Linker

Compiling

For compiling, use the `mcc68k` command in your Microtec C Compiler with the following option switches:

<code>-g</code>	Outputs debugging information.
<code>-Gf</code>	Generates fully-qualified path names for input files.
<code>-nOg</code>	Disables global flow optimization.
<code>-nOR</code>	Disables register variables.
<code>-Kf</code>	Creates frame pointers for functions.

Note The `-nOg` and `-nOR` options allow the debugger to display arguments during backtracing.

Note The `-Kf` option allows the debugger to trace function flow.

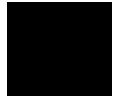

Assembling

For assembling, use the `asm68k` command in your Microtec Assembler with the following option switch:

`-fd` Creates local symbols.

Linking

For linking, use the `lnk68k` command in your Microtec Linker. Specify the IEEE-695 file format for the load module.

Example

To compile and link `sample.c` user program into a load module, execute the following command, where `sample.k` is the linker command file:

```
A> mcc68k -g -Gf -Kf -nOg -nOR -l -esample.k -osample.x  
sample.c -Wl,-m > sample.lst
```

Compiling Programs with AxLS

- 1** Compile the source files with the `cc68000` command.
- 2** Assemble the source files with the `as68k` command.
- 3** Link the object files with the `ld68k` command.

Required Compiler/Assembler/Linker

Compiler	HP AxLS CC68000 Compiler
Assembler	HP AxLS AS68K Assembler
Linker	HP AxLS LD68K Linker

Compiling

For compiling, use the `cc68000` command in your HP AxLS C Compiler with the following option switches:

`-Wc,-F` Disables register variables.

Note

The `-Wc,-F` option allows the debugger to display arguments during backtracing.

Assembling

For assembling, use the `as68k` command in your HP AxLS Assembler without any option switch.

Linking

For linking, use the `ld68k` command in your HP AxLS Linker. Specify the IEEE-695 file format for the load module.

Note

The Real-Time C Debugger does not support simulated I/O locations. You can use the `-N` compiler option to use a linker command file that does not include the simulated I/O library.

Example

To compile and link `sample.c` user program into a load module, execute the following command, where `sample.k` is the linker command file:

```
cc68000 -N -Wc,-F -Lix -k sample.k -o sample.x sample.c
```

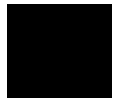

Trace Signals and Predefined Status Values

This section describes how emulation analyzer trace signals are assigned to microprocessor address bus, data bus, and control signals.

Emulation Analyzer Trace Signals

Trace Signals	Signal Name	Signal Description
0-23	A0-A23	Address Lines 0-23
24-31	STATUS	Status Lines
32-47	D0-D15	Processor Data 0-15
48	EDMA	External DMA
49	BCLR	Bus Clear Signal
50-53	CS3-0	Chip Select Signals
54	BERR	Bus Error Signal
55	ROM	ROM Memory Access Cycle
56	GRD	Guarded Memory Access Cycle
57-60	PB11-8	Port B pins 11-8
61-63	IPL0-2	Interrupt Priority Level

Predefined Status Values

Qualifier	Status Bits (31-24)	Description
bgd	00xxx xxxxy	Emulator in background.
byte	0xxxx xxx0y	Byte cycle.
data	0xxx0 lxxxxy	Data cycle.
dma	0x1xx xxxxy	Bus released to DMA device.
ext_cyc	0xxxx x0xxy	External processor cycle.
fgd	01xxx xxxxy	Emulator in foreground.
int_cyc	0xxxx xlxxx	Internal processor cycle.
intack	0xx1l lxxxxy	Interrupt acknowledge cycle.
not_dma	0x0xx xxxxy	Bus not released to DMA device.
prog	0xxx1 0xxxxy	Program cycle.
read	0xxxx xxlxy	Memory read.
sup	0xx1x xxxxy	Supervisor data cycle.
supdata	0xx10 lxxxxy	Supervisor cycle.
supprog	0xx1l 0xxxxy	Supervisor program cycle.
user	0xx0x xxxxy	User cycle.
userdata	0xx00 lxxxxy	User data cycle.
userprog	0xx01 0xxxxy	User program cycle.
word	0xxxx xxxly	Word cycle.
write	0xxxx xx0xy	Memory write.

Part 5

Installation Guide

Instructions for installing the product.

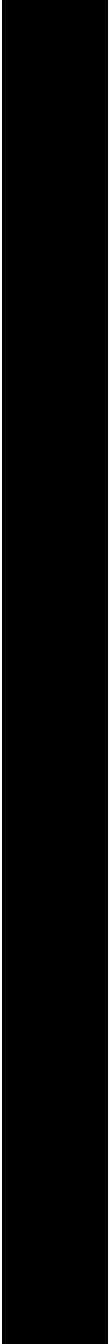

14

Installing the Debugger

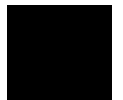

Installing the Debugger

This chapter shows you how to install the Real-Time C Debugger.

- Requirements
- Before Installing the Debugger
- Step 1. Connect the HP 64700 to the PC
- Step 2. Install the debugger software
- Step 3. Start the debugger
- Step 4. Check the HP 64700 system firmware version
- Optimizing PC Performance for the Debugger

Requirements

- IBM compatible or NEC PC with an 80486 microprocessor and 8 megabytes of memory.
- MS Windows 3.1, set up with 20 megabytes of swap space.
- VGA Display.
- 3 Megabytes available disk space.
- Serial port, HP 64037 RS-422 port, or Novell LAN with Lan Workplace for DOS or Microsoft Lan Manager with HP ARPA Services.
- Revision A.04.00 or greater of HP 64700 system firmware. The last step in this chapter shows you how to check the firmware version number.

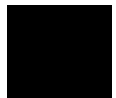

Before Installing the Debugger

- **Install MS Windows according to its installation manual. The Real-Time C Debugger must run under MS Windows in the 386 enhanced mode.**

To ensure your PC is running in the 386 Enhanced Mode, double-click the PIF Editor in the Main or Accessories window. Choose the Mode pulldown in the PIF Editor menu bar. A check mark should be beside "386 Enhanced" in the Mode pulldown.

- **If the HP 64700 is to communicate with the PC via LAN:**

Make sure the HP 64700 LAN interface is installed (see the "HP 64700 Series Installation/Service" manual).

Install the LAN card into the PC, and install the required PC networking software.

Obtain the Internet Address, the Gateway Address, and the Subnet Mask to be used for the HP 64700 from your Network Administrator. These three addresses are entered in integer dot notation (for example, 192.35.12.6).

- **If the HP 64700 is to communicate with the PC via RS-422:**

Install the HP 64037 RS-422 interface card into the PC. The Real-Time C Debugger includes software that configures the RS-422 interface.

Step 1. Connect the HP 64700 to the PC

You can connect the HP 64700 to an RS-232 serial port on the PC, the Local Area Network that the PC is on, or an HP 64037 RS-422 interface that has been installed in the PC.

- To connect via RS-232
- To connect via LAN
- To connect via RS-422

To connect via RS-232

- 1 Set the HP 64700 configuration switches for RS-232C communication. Locate the COMM CONFIG switches on the HP 64700 rear panel, and set them as shown below.

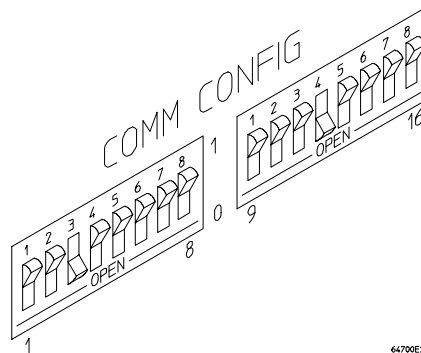

Notice that switches 1 through 3 are set to 001, respectively. This sets the baud rate to 19200.

Notice also that switches 12 and 13 are set to 1 and 0, respectively. This sets the RTS/CTS hardware handshake which is needed to make sure all characters are processed.

Chapter 14: Installing the Debugger
Step 1. Connect the HP 64700 to the PC

- 2 Connect an RS-232C modem cable from the PC to the HP 64700 (for example, an HP 24542M 9-pin to 25-pin cable or an HP 13242N 25-pin to 25-pin cable).

If you want to build your own RS-232 cable, follow one of the pin-outs for HP cables shown in the following figure.

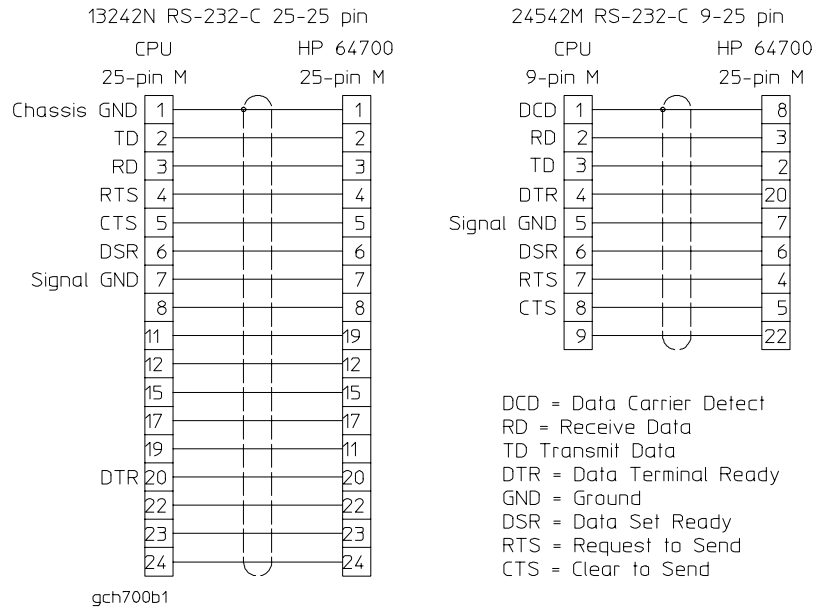

You can also use an RS-232C printer cable, but you must set HP 64700 configuration switch 4 to 1.

- 3 Turn ON power to the HP 64700.

The power switch is located on the lower left-hand corner of the front panel. The power lamp at the lower right-hand corner of the front panel will light.

- 4 Start MS Windows in the 386 enhanced mode.
- 5 Verify RS-232 communication by using the Terminal program that is found in the Windows "Accessories" group box.

Double-click on the "Terminal" icon to open the Terminal window. Then, choose the Settings→Communications... (ALT, S, C) command, and select: 19200 Baud Rate, 8 Data Bits, 1 Stop Bit, Parity None, Hardware Flow Control, and the PC's RS-232 interface connector. Choose the OK button.

You should now be able to press the Enter key in the Terminal window to see the HP 64700's Terminal Interface prompt (for example, "R>", "M>", or "U>". The "->" prompt indicates the present firmware does not match the emulator probe, or there is no probe connected). If you see the prompt, you have verified RS-232 communication. If you do not see the prompt, refer to "If you cannot verify RS-232 communication".

If you will be using the RS-232 connection for the debugger, exit the Terminal program and go to "Step 2. Install the debugger software".

If you will be using the LAN connection, go to "To connect via LAN".

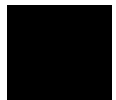

To connect via LAN

1 Set the HP 64700 LAN parameters.

If you're setting the HP 64700 LAN parameters for the first time, you must connect the HP 64700 to the PC via RS-232 before you can access the HP 64700 Terminal Interface. Follow the steps in "To connect via RS-232" and then return here.

If you're changing the LAN parameters of an HP 64700 that is already on the LAN, you can use the "telnet <HP 64700 IP address>" command to access the HP 64700 Terminal Interface.

Once the HP 64700 Terminal Interface has been accessed, display the current LAN parameters by entering the "lan" command:

```
R>lan
lan -i 15.6.25.117
lan -g 15.6.24.1
lan -s 255.255.248.0 <<- HP 64700A ONLY
lan -p 6470
Ethernet Address : 08000909BBC1
```

The "lan -i" line shows the Internet Address (or IP address). The Internet Address must be obtained from your Network Administrator. The value is entered in integer dot notation. For example, 192.35.12.6 is an Internet Address. You can change the Internet Address with the "lan -i <new IP>" command.

The "lan -g" line shows the Gateway Address which is also an Internet address and is entered in integer dot notation. This entry is optional and will default to 0.0.0.0, meaning all connections are to be made on the local network or subnet. If connections are to be made to workstations on other networks or subnets, this address must be set to the address of the gateway machine. The gateway address must be obtained from your Network Administrator. You can change the Gateway Address with the "lan -g <new gateway address>" command.

The "lan -s" line will be shown if you are using the HP 64700A, and will not be shown if you are using the HP 64700B. If this line is not shown, the Subnet Mask is automatically configured. If this line is shown, it shows the Subnet Mask in integer dot notation. This entry is optional and will default to 0.0.0.0. The default is valid only on networks that are not subnetted. (A network is

subnetted if the host portion of the Internet address is further partitioned into a subnet portion and a host portion.) If the network is subnetted, a subnet mask is required in order for the emulator to work correctly. The subnet mask should be set to all "1"s in the bits that correspond to the network and subnet portions of the Internet address and all "0"s for the host portion. The subnet mask must be obtained from your Network Administrator. You can change the Subnet Mask with the "lan -s <new subnet mask>" command .

Both the PC's subnet mask and the emulator's subnet mask must be identical unless they communicate via a gateway or a bridge. Unless your Network Administrator states otherwise, make them the same. You can check the PC's subnet mask with the "lminst" command if you are using HP-ARPA. If you are using Novell LAN WorkPlace, make sure the file \NET.CFG has the entry "ip_netmask <subnet mask>" in the section "Protocol TCPIP".

The "lan -p" line shows the base TCP service port number. The host computer interfaces communicate with the HP 64700 through two TCP service ports. The default base port number is 6470. The second port has the next higher number (default 6471). If the service port is not 6470, you must change it with the "lan -p 6470" command.

The Internet Address and any other LAN parameters you change are stored in nonvolatile memory and will take effect the next time the HP 64700 is powered off and back on again.

- 2 Exit the Terminal or telnet program.**
- 3 Turn OFF power to the HP 64700.**
- 4 Connect the HP 64700 to the LAN. This connection can be made using either the 15-pin AUI connector or the BNC connector.**

DO NOT use both connectors. The LAN interface will not work with both connected at the same time.

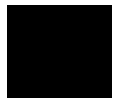

Chapter 14: Installing the Debugger
Step 1. Connect the HP 64700 to the PC

5 Set the HP 64700 configuration switches for LAN communication.

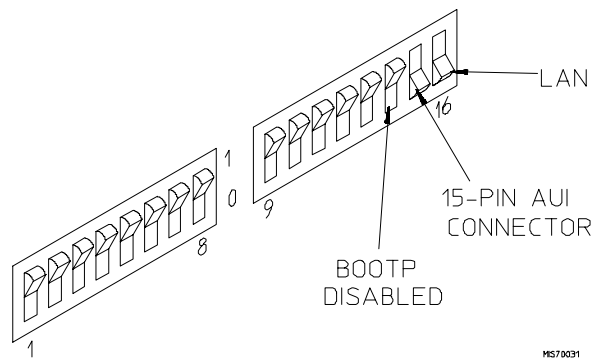
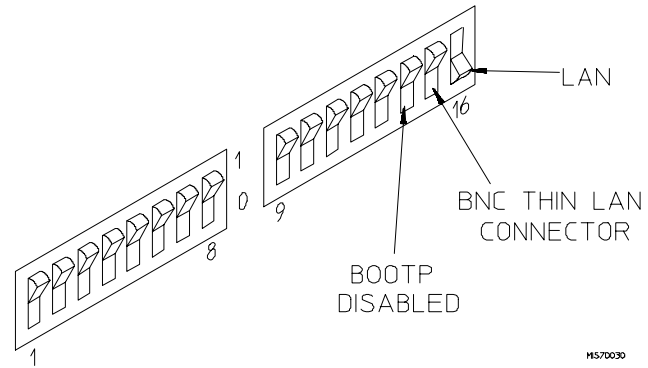

Switch 16 must be set to one (1) indicating that a LAN connection is being made.

Switch 15 should be zero (0) if you are connecting to the BNC connector or set to one (1) if a 15 pin AUI connection is made.

Switch 14 should be zero (0).

Set all other switches to zero (0).

- 6** Turn ON power to HP 64700.
- 7** Verify LAN communication by using a "telnet <HP 64700 IP address>" command. This connection will give you access to the HP 64700 Terminal Interface.

You should now be able to press the Enter key in the telnet window to see the HP 64700's Terminal Interface prompt (for example, "R>", "M>", "U>", etc.). If you see the prompt, you have verified LAN communication. If you cannot connect to the HP 64700's IP address, refer to "If you cannot verify LAN communication".

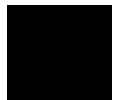

To connect via RS-422

Before you can connect the HP 64700 to the PC via RS-422, the HP 64037 RS-422 Interface must have already been installed into the PC.

- 1** Set the HP 64700 configuration switches for RS-422 communication. Locate the COMM CONFIG switches on the HP 64700 rear panel, and set them as shown below.

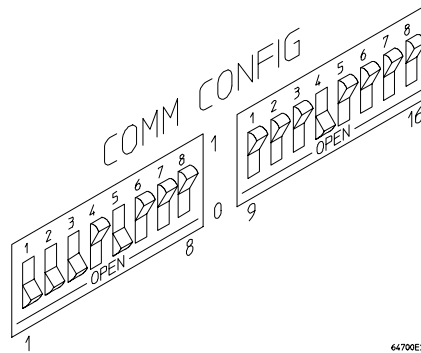

Notice that switches 1 through 3 are set to 111, respectively. This sets the baud rate to 230400.

Notice that switch 5 is set to 1. This configures the 25-pin port for RS-422 communication.

Notice also that switches 12 and 13 are set to 1 and 0, respectively. This sets the RTS/CTS hardware handshake which is needed to make sure all characters are processed.

- 2** Connect the 17355M cable (which comes with the HP 64037 interface) from the PC to the HP 64700.
- 3** Turn ON power to the HP 64700.

The power switch is located on the lower left-hand corner of the front panel. The power lamp at the lower right-hand corner of the front panel will light.

If you cannot verify RS-232 communication

If the HP 64700 Terminal Interface prompt does not appear in the Terminal window:

- Make sure that you have connected the emulator to the proper power source and that the power light is lit.

- Make sure that you have properly configured the data communications switches on the emulator and the data communications parameters on your controlling device. You should also verify that you are using the correct cable.

The most common type of data communications configuration problem involves the configuration of the HP 64700 as a DCE or DTE device and the selection of the RS-232 cable. If you are using the wrong type of cable for the device selected, no prompt will be displayed.

When the RS-232 port is configured as a DCE device (S4 is set to 0), a modem cable should be used to connect the HP 64700 to the host computer of terminal. Pins 2 and 3 at one end of a modem cable are tied to pins 2 and 3 at the other end of the cable.

When the RS-232 port is configured as a DTE device (S4 is set to 1), a printer cable should be used to connect the HP 64700 to the host computer of terminal. Pins 2 and 3 at one end of a printer cable are swapped and tied to pins 3 and 2, respectively, at the other end of the cable.

If you suspect that you may have the wrong type of cable, try changing the S4 setting and turning power to the HP 64700 OFF and then ON again.

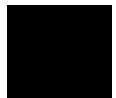

If you cannot verify LAN communication

Use the "telnet" command on the host computer to verify LAN communication. After powering up the HP 64700, it takes a minute before the HP 64700 can be recognized on the network. After a minute, try the "telnet <internet address>" command.

- If "telnet" does not make the connection:
 - Make sure that you have connected the emulator to the proper power source and that the power light is lit.
 - Make sure that the LAN cable is connected. Refer to your LAN documentation for testing connectivity.
 - Make sure the HP 64700 rear panel communication configuration switches are set correctly. Switch settings are only used to set communication parameters in the HP 64700 when power is turned OFF and then ON.
 - Make sure that the HP 64700's Internet Address is set up correctly. You must use the RS-232 port to verify this that the Internet Address is set up correctly. While accessing the emulator via the RS-232 port, run performance verification on the HP 64700's LAN interface with the "lanpv" command.
- If "telnet" makes the connection, but no Terminal Interface prompt (for example, R>, M>, U>, etc.) is supplied:
 - It's possible that the HP 64000 software is in the process of running a command (for example, if a repetitive command was initiated from telnet in another window). You can use CTRL+c to interrupt the repetitive command and get the Terminal Interface prompt.
 - It's also possible for there to be a problem with the HP 64700 firmware while the LAN interface is still up and running. In this case, you must turn OFF power to the HP 64700 and turn it ON again.

Step 2. Install the debugger software

- 1 If you are updating or re-installing the debugger software, you may want to save your B3638.INI file because it will be overwritten by the installation process.
- 2 Start MS Windows in the 386 enhanced mode.
- 3 Insert the 6830X REAL-TIME C DEBUGGER Disk 1 of 2 into floppy disk drive A or B.
- 4 Choose the File→Run... (ALT, F, R) command in the Windows Program Manager. Enter "a:\setup" (or "b:\setup" if you installed the floppy disk into drive B) in the Command Line text box.

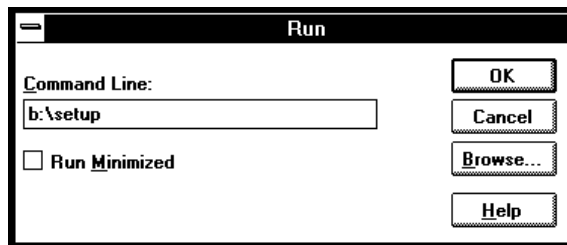

Then, choose the OK button. Follow the instructions on the screen.

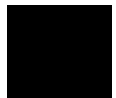

Chapter 14: Installing the Debugger
Step 2. Install the debugger software

You will be asked to enter the installation path. The default installation path is C:\HP\RTC\M30X. The default installation path is shown wherever files are discussed in this manual.

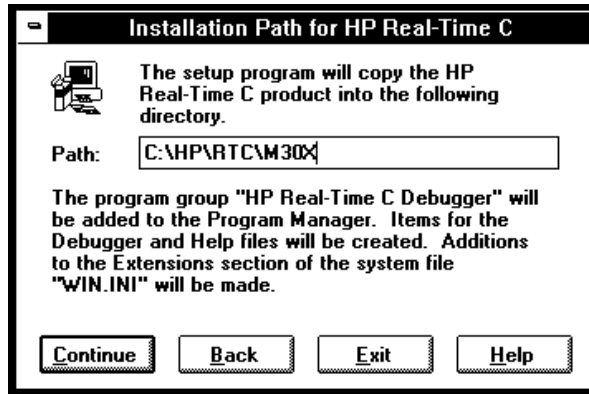

You will be asked to enter your user ID. This information is important if the HP 64700 is on the LAN and may be accessed by other users. It tells other users who is currently using, or who has locked, the HP 64700. This information can be modified while using the Real-Time C Debugger by choosing the Settings→Communication... (ALT, S, C) command.

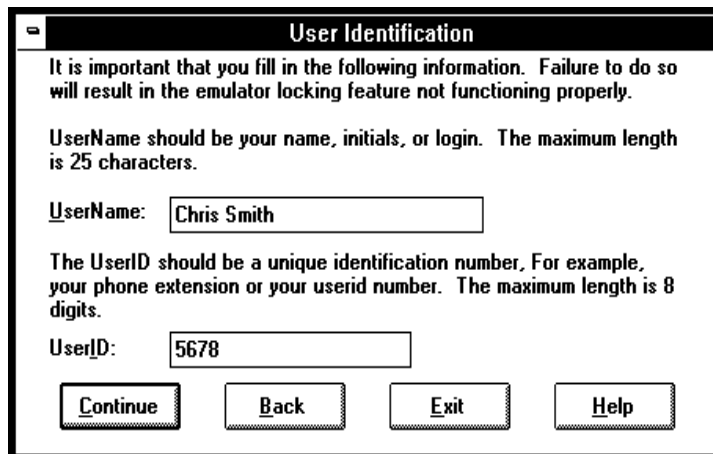

You will be asked to select the type of connection to be made to the HP 64700. This information can be modified while using the Real-Time C Debugger by choosing the Settings→Communication... (ALT, S, C) command.

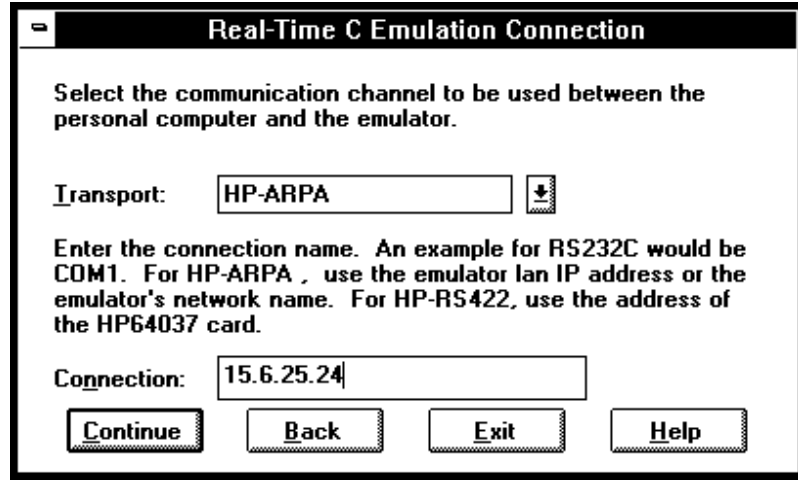

When using the HP-RS422 transport, the connection name is the I/O address you want to use for the HP 64037 card. Enter a hexadecimal number from 100H through 3F8H, ending in 0 or 8, that does not conflict with other cards in your PC.

After you have specified the type of connection, files will be copied to your hard disk. (The B3638.TMP and B3638.HLP files are larger than most of the other files and take longer to copy.) Fill out your registration information while waiting for the files to be copied.

If the Setup program detects that one or more of the files it needs to install are currently in use by Windows, a dialog box informs you that Windows must be restarted. You can either choose to restart Windows or not. If you don't choose to restart Windows, you can either run the _MSSETUP.BAT batch file (in the same directory that the debugger software is installed in) after you have exited Windows or reinstall the debugger software later when you are able to restart Windows.



Step 3. Start the debugger

- 1 If the "HP Real-Time C Debugger" group box is not opened, open it by double-clicking in the icon.
- 2 Double-click the "M6830X Real-Time C Debugger" icon.

If you have problems connecting to the HP 64700, refer to:

- If you have RS-232 connection problems
- If you have LAN connection problems
- If you have RS-422 connection problems

If you have RS-232 connection problems

- Remember that Windows 3.1 only allows two active RS-232 connections at a time. To be warned when you violate this restriction, choose Always Warn in the Device Contention group box under 386 Enhanced in the Control Panel.
- Use the "Terminal" program (usually found in the Accessories windows program group) and set up the "Communications..." settings as follows:

```
Baud Rate: 19200 (or whatever you have chosen for the emulator)
Data Bits: 8
Parity: None
Flow Control: Hardware
Stop Bits: 1
```

When you are connected, hit the Enter key. You should get a prompt back. If nothing echos back, check the switch settings on the back of the emulator.

Switches 1 thru 3 set the baud rate as follows:

S1	S2	S3	
0	0	0	9600
0	0	1	19200
0	1	0	2400

Switches 12 and 13 must be set to 1 and 0, respectively. This sets the RTS/CTS hardware handshake, which is needed to make sure all characters are processed.

All other switches should be in the "0" position, especially switch 16 on the HP 64700 (which selects LAN/Serial interface).

Remember that if you change any of the switch positions, you must turn OFF power to the HP 64700 and turn it ON again before the changes will take effect.

- If the switches are in the correct position and you still do not get a prompt when you press return, check the following:
 - Turn off power to the HP 64700 and then turn it on again. Press return to see if you get a prompt.
 - Check to make sure the RS-232 cable is connected to the correct port on your PC, and that the cable is appropriate for connecting the PC to a DCE device. If the cable is intended to connect the PC to a DTE device, set switch 4 to "1" (which makes the emulator a DTE device), turn OFF power to the HP 64700, turn power ON, and try again.
 - Check to make sure your RS-232 cable has the RTS, CTS, DSR, DCD, and DTR pins supported. If your PC RS-232 connection is a 9-pin male connection, HP cable number 24542M will work (set switch 4 to 0 if you use this cable). If your PC has a 25-pin RS-232 connector, HP cable number 13242N will work (set switch 4 to 0).

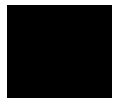

Chapter 14: Installing the Debugger
Step 3. Start the debugger

- If you wish to build your own RS-232 cable, refer to "To connect via RS-232" in the paragraph titled, "Step 1. Connect the HP 64000 to the PC" earlier in this chapter.
- When using certain RS-232 cards, connecting to an RS-232 port where the HP 64700 is turned OFF (or not connected) will halt operation of the PC. The only way to restore operation is to reboot the PC. Therefore, HP recommends you always turn ON the HP 64700 before attempting to connect via RS-232.
- If RTC reports overrun errors or simply times out, RTC may be overrunning the serial interface. In this case, try the following:
 - Stop all unnecessary TSR's and other applications to allow the processor to service the serial interface more often.
 - Overrun errors may occur when the serial interface card is not sufficiently buffered. Check to make sure your serial interface card uses the 16550AF UART, or better. Use the DOS command, "MSD", and when the window opens, select "COM Ports..." to see the UART chip used in your serial interface card.

If you have LAN connection problems

- Try to "ping" the emulator:

```
ping <hostname or IP address>
```

- If the emulator does not respond:

- Check that switch 16 on the emulator is "1" (emulator is attached to LAN, not RS-232 or RS-422).
- Check that switch 15 on the emulator is in the correct position for your LAN interface (either the AUI or the BNC).

Remember, if you change any switch settings on the emulator, the changes do not take effect until you turn OFF emulator power and turn it ON again.

- If the emulator still does not respond to a "ping," you need to verify the IP address and subnet mask of the HP 64700. To do this, connect the HP 64700 to a terminal (or to the Terminal application on the PC), change the emulator's switch settings so it is connected to RS-232, and enter the "lan" command. The output looks something like this:

```
lan -i 15.6.25.117
lan -g 15.6.24.1
lan -s 255.255.248.0
lan -p 6470
Ethernet Address : 08000909BBC1
```

The important outputs (as far as connecting) are:

"lan -i"; this shows the internet address is 15.6.25.117 in this case. If the Internet address (IP) is not what you expect, you can change it with the 'lan -i <new IP>' command.

"lan -s"; shows the subnet mask is 255.255.248 (the upper 21 bits -- 255.255.248.0 == FF.FF.F8.0). If the subnet mask is not what you expect, you can change it with the 'lan -s <new subnet mask>' command.

"lan -p"; shows the port is 6470. If the port is not 6470, you must change it with the "lan -p 6470" command.

Both the PC's subnet mask and the emulator's subnet mask must be identical unless they communicate via a gateway or a bridge. Unless your Network

Chapter 14: Installing the Debugger
Step 3. Start the debugger

Administrator states otherwise, make them the same. If you are using HP-ARPA, you can check the PC's subnet mask with the "lminst" command in a DOS window. If you are using Novell LAN WorkPlace, make sure the file \NET.CFG has the entry "ip_netmask <subnet mask>" in the section "Protocol TCPIP." If you are using Windows for Workgroups, you can check the PC's subnet mask by looking in the [TCPIP] section of the PROTOCOL.INI file or by looking in the Microsoft TCP/IP Configuration dialog box. If you are using WINSOCK, refer to your LAN software documentation for subnet mask information.

- Occasionally the emulator or the PC will "lock up" the LAN due to excessive network traffic. If this happens, all you can do is turn OFF power to the HP 64700 or PC and turn it back ON, again. If this happens two frequently, you can try placing a gateway between the emulator/PC and the rest of your network.

If you have LAN DLL errors

The various LAN transport selections require the following DLLs:

HP-ARPA	WSOCKETS.DLL.
Novell-WP	WLIBSOCK.DLL.
W4WG-TCP	WSOCKETS.DLL. (Windows for Workgroups)
WINSOCK1.1	WINSOCK.DLL.

These DLLs are included with LAN software. The required DLL must be in your search path. This will be the case if your network software is installed.

If you have RS-422 connection problems

- RS-422 is only usable with Windows Version 3.1.
- Make sure the HP 64700 switch settings match the baud rate chosen when attempting the connection.

Switches 1 thru 3 set the baud rate as follows:

S1	S2	S3	
1	1	1	230400
1	1	0	115200
1	0	1	38400
1	0	0	57600
0	1	1	1200
0	1	0	2400
0	0	1	19200
0	0	0	9600

Switch 5 must be set to 1 to configure the HP 64700 for RS-422 communication.

Switches 12 and 13 must be set to 1 and 0, respectively. This sets the RTS/CTS hardware handshake, which is needed to make sure all characters are processed.

All other switches should be in the "0" position, especially the switch that determines LAN/Serial interface (switch 16 on HP 64700).

Remember that if you change any of the switch positions, you must turn OFF power to the HP 64700 and turn it ON again before the changes will take effect.

- If the switches are in the correct position and you still do not get a prompt when you hit return, try turning OFF the power to the HP 64700 and tuning it ON again.
- If you still don't get a prompt, make sure the HP 17355M RS-422 cable is connected to the correct port on your PC.

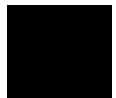

Step 4. Check the HP 64700 system firmware version

- Choose the Help→About Debugger/Emulator... (ALT, H, D) command.

The version information under HP 64700 Series Emulation System must show A.04.00 or greater. If the version number is less than A.04.00, you must update your HP 64700 system firmware as described in the Installing/Updating HP 64700 Firmware chapter.

Optimizing PC Performance for the Debugger

The Real-Time C Debugger is a memory and I/O intensive Windows program. Slow user interface performance may be caused by many things:

- Underpowered PC -- The Real-Time C Debugger requires an IBM compatible or NEC PC with an 80486 class microprocessor, 8 megabytes of memory, and 20 megabytes of MS Windows swap space. Because RAM is faster than swap, performance is best when there is enough RAM to accommodate all of the Real-Time C Debugger's memory usage (which is directly related to the size of your programs and the amount of debug information in them).
- Improperly configured PC -- Windows configuration may have a very significant effect on performance. The Windows swap file settings are very important (see the Virtual Memory dialog box under 386 Enhanced in the Control Panel). The larger the swap file, the better the performance. Permanent swap has superior performance.
- Disk performance (due to Windows swap file access and Windows dialog and string resource accesses from the debugger ".EXE" file) -- The disk speed has a direct impact on performance of the Real-Time C Debugger. Use of SMARTDrive or other RAM disk or caching software will improve the performance.

Various PC performance measurement and tuning tools are commercially available. Optimizing your PC performance will improve debugger interface performance and, of course, all your other PC applications will benefit as well.

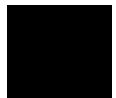



Installing/Updating HP 64700
Firmware

Installing/Updating HP 64700 Firmware

This chapter shows you how to install or update HP 64700 firmware.

Note

If you are using an HP 64700A, it must contain the optional Flash EPROM memory card before you can install or update HP 64700 system firmware. Flash EPROM memory is standard in the HP 64700B card cage.

The firmware, and the program that downloads it into the HP 64700, are included with the debugger on floppy disks labeled HP 64700 EMUL/ANLY FIRMWARE.

The steps to install or update HP 64700 firmware are:

- Step 1. Connect the HP 64700 to your PC
- Step 2. Install the firmware update utility
- Step 3. Run PROGFLASH to update HP 64700 firmware
- Step 4. Verify emulator performance

Step 1. Connect the HP 64700 to the PC

- 1 Set the COMM CONFIG switches for RS-232C communication. To do this, locate the DIP switches on the HP 64700 rear panel, and set them as shown below.

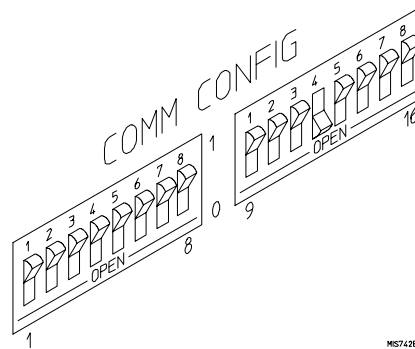

Notice that switches 12 and 13 are set to 1 and 0, respectively. This sets the RTS/CTS hardware handshake, which is needed to make sure all characters are processed. Switches 1, 2, and 3 are set to 0. This sets the baud rate to 9600. Switch settings are read during the HP 64700 power up routine.

- 2 Connect an RS-232C modem cable from the PC to the HP 64700 (for example, an HP 24542M 9-pin to 25-pin cable or an HP 13242N 25-pin to 25-pin cable).

You can also use an RS-232C printer cable, but if you do, you MUST set COMM CONFIG switch 4 to 1.

- 3 Turn ON power to the HP 64700.

The power switch is located on the lower left-hand corner of the front panel. The power lamp at the lower right-hand corner of the front panel will light.

4 Start MS Windows in the 386 enhanced mode.

To ensure your PC is running in the 386 Enhanced Mode, double-click the PIF Editor in the Main or Accessories window. Choose the Mode pulldown in the PIF Editor menu bar. A check mark should be beside "386 Enhanced" in the Mode pulldown.

5 Verify RS-232 communication by using the Terminal program that is found in the Windows "Accessories" group box.

Double-click on the "Terminal" icon to open the Terminal window. Then, choose the Settings→Communications... (ALT, S, C) command, and select: 9600 Baud Rate, 8 Data Bits, 1 Stop Bit, Parity None, Hardware Flow Control, and the PC's RS-232 interface connector to which the RS-232 cable is attached (example: COM1). Choose the OK button.

You should now be able to press the Enter key in the Terminal window to see the HP 64700's Terminal Interface prompt (for example, p>, R>, M>, and U>. A -> prompt indicates the present firmware does not match the emulator probe, or there is no probe connected). If you see the prompt, you have verified RS-232 communication. If you do not see the prompt, refer to "If you cannot verify RS-232 communication" in Chapter 14.

6 Exit the Terminal window.

Step 2. Install the firmware update utility

The firmware update utility and emulation and analysis firmware require about 1.5 Mbytes of disk space.

- 1 Start MS Windows in the 386 enhanced mode.
- 2 Insert the HP 64700 EMUL/ANLY FIRMWARE Disk 1 of 2 into floppy disk drive A or B.
- 3 Choose the File→Run... (ALT, F, R) command in the Windows Program Manager. Enter "a:\setup" (or "b:\setup" if you installed the floppy disk into drive B) in the Command Line text box.

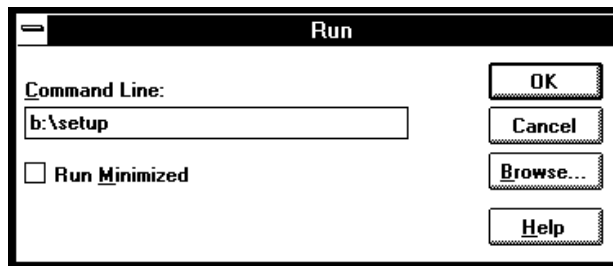

Then, choose the OK button. Follow the instructions on the screen.

You will be asked to enter the installation path. The default installation path is C:\HP64700.

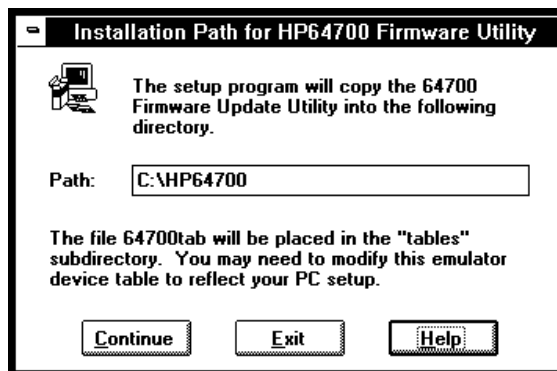

Chapter 15: Installing/Updating HP 64700 Firmware
Step 2. Install the firmware update utility

Wait until the Setup Exit Message dialog box appears. This indicates installation of the firmware update utility is complete.

- 4 After completing the installation, use the editor of your choice and edit the C:\CONFIG.SYS file to include these lines:

```
BREAK=ON  
FILES=20
```

BREAK=ON allows the system to check for two break conditions: CTRL+Break, and CTRL+c.

FILES=20 allows 20 files to be accessed concurrently. This number must be at LEAST 20 to allow the firmware update utility to operate properly.

- 5 If you installed the files in a path other than the default (C:\HP64700), edit the C:\AUTOEXEC.BAT and C:\HP64700\BIN\FLASH.BAT files as follows:

- Edit AUTOEXEC.BAT to set the HP64700 and HPTABLES environment variables. For example:

```
SET HP64700=C:\<installation_path>  
SET HPTABLES=C:\<installation_path>\TABLES
```

- Edit FLASH.BAT to identify the location of PROGFLAS.EXE. For example:

```
C:\<installation_path>\PROGFLAS.EXE
```

- 6 Edit the <installation_path>\TABLES\64700TAB file to indicate the communications connection you will use, as follows:

The default <installation_path>\TABLES\64700TAB file contains entries to establish the communications connection for COM1 and COM2. The content of this file is:

```
EMUL_COM1 unknown COM1 OFF 9600 NONE ON 1 8  
EMUL_COM2 unknown COM2 OFF 9600 NONE ON 1 8
```

If you are using COM3 or COM4 port to update your firmware, you need to edit the <installation_path>\TABLES\64700TAB file. Either add another line or modify one of the existing lines. For example:

```
EMUL_COM3 my_emul COM3 OFF 9600 NONE ON 1 8  
EMUL_COM4 unknown COM4 OFF 9600 NONE ON 1 8
```

7 Ensure the Interrupt Request Line for the selected COMx port is set to its default value. To check the default value:

- 1** Choose Control Panel in the Main window.
- 2** Choose Ports in the Control Panel window.
- 3** Choose the COMx port you are using and click Settings....
- 4** Click Advanced... in the Settings for COMx dialog box.
- 5** Select the default value for the Interrupt Request Line in the Advanced Settings for COMx dialog box. The default settings are:

```
COM1 and COM3 = IRQ 4  
COM2 and COM4 = IRQ 3
```

8 Exit Windows and reboot your PC to activate the changes made to the CONFIG.SYS and AUTOEXEC.BAT files (CTRL+ALT+DEL). Installation of the firmware update utility is now complete.

Step 3. Run PROGFLASH to update HP 64700 firmware

- 1 Start MS Windows in the 386 enhanced mode.
- 2 If the "HP 64700 Firmware Utility" group box is not opened, open it by double-clicking the icon.
- 3 Double-click the "PROGFLASH" icon. (You can abort the PROGFLASH command by pressing CTRL+c.)
- 4 Enter the number that identifies the emulator you want to update. For example, enter "1" if you want to update the emulator identified by the line, "1 emul_com1 my_emul."
- 5 Enter the number that identifies the product whose firmware you want to update. For example, if this product is listed as number 12, enter "12":

```
Product
1  64782
2  E3490
.
.
12 647??
.
```

- 6 Enter "y" to enable status messages.

Chapter 15: Installing/Updating HP 64700 Firmware
Step 3. Run PROGFLASH to update HP 64700 firmware

The PROGFLASH command downloads code from files on the host computer into Flash EPROM memory in the HP 64700. During this download, you will see messages similar to the following:

```
Rebooting HP64700...with init -r

Downloading flash programming code:
'/hp64700/lib/npf.X'
Checking Hardware id code...
Erasing Flash ROM
Downloading ROM code: '/hp64700/update/647???.X'
  Code start 280000H
  Code size 29ABAH
Finishing up...

Rebooting HP64700...
Flash programming SUCCEEDED
```

You can display firmware version information and verify the update by choosing the Help→About Debugger/Emulator... (ALT, H, D) command in the Real-Time C Debugger.



Step 4. Verify emulator performance

- Do the performance verification procedure shown in the Installation/Service/Terminal Interface User's Guide.

Glossary

Defines terms that are used in the debugger help information.

analyzer An instrument that captures data on signals of interest at discrete periods. The emulation bus analyzer captures emulator bus cycle information synchronously with the processor's clock signal.

arm condition A condition that enables the analyzer. The analyzer is always armed unless you set the analyzer up to be armed by a signal received on the BNC port; when you do this, you can identify the arm condition in the trace specification by selecting arm in the Condition dialog boxes.

background memory A separate memory system, internal to the emulator, out of which the background monitor executes.

background monitor program An emulation monitor program that executes out of background memory.

break on trigger Causes emulator execution to break into the monitor when the trigger condition is found. This is known as a hardware breakpoint, and it lets you break on a wider variety of conditions than a software breakpoint (which replaces an opcode with a break instruction); however, depending on the speed of the processor, the actual break point may be several cycles after the one that caused the trigger.

breakpoint An address you identify in the user program where program execution is to stop. Breakpoints let you look at the state of the target system at particular points in the program.

break macro A breakpoint followed by any number of macro commands (which are the same as command file commands).

control menu The menu that is accessed by clicking the control menu box in the upper left corner of a window. You can also access control menus by pressing the "ALT" and "-" keys.

count condition Specifies whether time or the occurrences of a particular state are counted for each state in the trace buffer.

embedded microprocessor system The microprocessor system that the emulator plugs into.

emulation memory Memory provided by the emulator that can be used in place of memory in the target system.

emulation monitor A program, executed by the emulation microprocessor (as directed by the emulation system controller), that gives the emulator access to target system memory, microprocessor registers, and other target system resources.

emulator An instrument that performs just like the microprocessor it replaces, but at the same time, it gives you information about the operation of the processor. An emulator gives you control over target system execution and allows you to view or modify the contents of processor registers, target system memory, and I/O resources.

enable condition Specifies the first condition in a two-step sequential trigger condition.

enable store condition Specifies which states get stored in the trace buffer while the analyzer searches for the enable condition.

foreground memory The memory system out of which user programs execute. Foreground memory is made up of emulation memory and target system memory.

foreground monitor program An emulation monitor program that executes out of the same memory system as user programs. This memory system is known as foreground memory and is made up of emulation memory and target system memory. The 6830x emulator does not offer a foreground monitor program.

guarded memory Memory locations that should not be accessed by user programs. These locations are specified when mapping memory. If the user program accesses a location mapped as guarded memory, emulator execution breaks into the monitor.

macro Refers to a break macro, which is a breakpoint followed by any number of macro commands (which are the same as command file commands).

monitor A program, executed by the emulation microprocessor (as directed by the emulation system controller), that gives the emulator access to target system memory, microprocessor registers, and other target system resources.

object file An Intel OMF format absolute file that can be loaded into emulation or target system memory and executed by the debugger.

overlapping address ranges Two or more logical address ranges that are identified by the same numerical values. For example, the following two address ranges are overlapping:

1000..1fff@s
1000..1fff@u

Each range is accessed by translating the logical address along with the function code, supervisor or user in this example. Address 1010@s is a different physical location from address 1010@u.

pop-up menu A menu that is accessed by clicking the right mouse button in a window.

prestore condition Specifies the states that may be stored before each normally stored state. Up to two states may be prestored for each normally stored state.

primary branch condition Specifies a condition that causes the analyzer to begin searching at another level.

restart condition Specifies the condition that restarts the two-step sequential trigger. In other words, if the restart condition occurs while the analyzer is searching for the trigger condition, the analyzer starts looking for the enable condition again.

secondary branch condition Specifies a condition that causes the analyzer to begin searching at another level. If a state satisfies both the primary and secondary branch conditions, the primary branch will be taken.

sequence levels Levels in the analyzer that let you specify a complex sequential trigger condition. For each level, the analyzer searches for primary and secondary branch conditions. You can specify a different store condition for each level. The Page button toggles the display between sequence levels 1 through 4 and sequence levels 5 through 8.

state qualifier A combination of address, data, and status values that identifies particular states captured by the analyzer.

status values Values that identify the types of microprocessor bus cycles recognized by the analyzer. You can include status values (along with address and data values) when specifying trigger and store conditions. The status values defined for the 6830x emulator are listed under "Predefined Status Values" at the end of Chapter 13, "Concepts."

store condition Specifies which states get stored in the trace buffer.

In the "Find Then Trigger" trace set up, the store condition specifies the states that get stored after the trigger.

In the "Sequence" trace set up, each sequence level has a store condition that specifies the states that get stored while looking for the primary or secondary branch conditions.

target system The microprocessor system that the emulator plugs into.

trace state The information captured by the analyzer on a particular microprocessor bus cycle.

transfer address The program's starting address defined by the software development tools and included with the symbolic information in the object file.

trigger The captured analyzer state about which other captured states are stored. The trigger state specifies when the trace measurement is taken.

trigger condition Specifies the condition that causes states to be stored in the trace buffer.

trigger position Specifies whether the state that triggered the analyzer appear at the start, center, or end of the trace buffer. In other words, the trigger position specifies whether states are stored after, about, or before the trigger.

trigger store condition Specifies which states get stored in the trace buffer while the analyzer searches for the trigger condition.

watchpoint A variable that has been placed in the WatchPoint window where its contents can be readily displayed and modified.



Index

- A** abort, during object file or memory load, 330
- absolute count information, displaying, 183, 385
- access size, target memory, 71, 120
- Add to Watch command, 397
- address strobe, buffering, 79
- addresses, searching, 133, 370
- analyzer, 497-501
 - editing the trace specification, 197, 270
 - halting, 181, 283
 - repeating last trace, 181, 284
 - setting up with "Find Then Trigger", 188, 274-277
 - setting up with "Sequence", 193, 278-281
 - setting up with "Trigger Store", 185, 271-273
 - trace signals, 458
 - tracing of DMA cycles, 83
 - tracing until halt, 181, 282
- arguments, function, 434, 455-456
- arm condition, 99, 188, 193, 285-287, 323, 497-501
- arrays (C operators), 215
- ASCII values in Memory window, 160, 440
- Assemble... (ALT, A) command, 301
- assembler, in-line, 301
- assembly code for setting up the SIM, displaying, 98
- assembly language instructions
 - stepping multiple, 145, 244-247
 - stepping single, 143, 242
- assembly language source files, 453
- auto variables, 157-159
- AUTOEXEC.BAT file, 491-493
- AxLS, compiling programs with, 456



- B** background memory, 497-501
- background monitor program, 497-501
- background operation, tracing, 328-329
- BackTrace window, 434
 - displaying source files, 395
- Bad RS-232 port name, 411
- Bad RS-422 card I/O address, 411
- baud rate, RS-232, 318
- baud rate, RS-422, 318
- beep, sounding from command file, 401
- BERR signal (target), enabling or disabling, 74
- binary values, how to enter, 211
- BNC port
 - driving the trigger signal, 321-322
 - output trigger signal, 99
 - receiving an arm condition from, 323
 - receiving an arm condition input, 99
 - setting up, 99
- BP marker, 33, 35, 152, 250-255, 443
- break into monitor, 147, 248
- break macros, 497-501
 - command summary, 204
 - deleting, 155, 255
 - listing, 152, 256-257
 - preventing new, 155
 - setting, 152, 252-254
- break on writes to ROM, enabling or disabling, 73
- breakpoints, 497-501
 - deleting, 35, 151, 156, 251
 - disabling and enabling, 151
 - listing, 152, 256-257
 - preventing new breakpoints, 156
 - setting, 33, 150, 250
 - specifying TRAP number for, 72
- Breakpoint→Delete at Cursor (ALT, B, D) command, 251
- Breakpoint→Delete Macro (ALT, B, L) command, 255
- Breakpoint→Edit... (ALT, B, E) command, 256-257
- Breakpoint→Set at Cursor (ALT, B, S) command, 250
- Breakpoint→Set Macro... (ALT, B, M) command, 252-254
- bus arbitration cycles, identifying in the trace, 182
- bus cycles only, displaying, 384

- bus cycles, displaying, 182
- bus interface ports, displaying information, 97
- bus width, selecting, 71
- Button window, 435
 - editing, 66, 343
- buttons that execute command files, creating, 66

C

- C operators, 215
- callers (of a function), tracing, 47-48, 175, 262-263
- chain command files, 403
- chip selects
 - buffering lines, 76
 - displaying information, 96
 - reprogramming base addresses, 112
 - setting up, 110
- Clear Breakpoint command, 396
- clipboard, 55
- clock crystal frequency error, 413-414
- clock setup, checking configuration for, 96
- clock source (emulator), selecting, 70
- colors in the Source window, setting, 63
- command files
 - chain, 403
 - command summary, 204
 - comments, 405
 - creating, 64, 224
 - executing, 65, 227-228
 - executing at startup, 57, 65
 - execution, exiting, 402
 - inserting wait delays, 408
 - locating cursor, 370
 - nesting, 403
 - parameters, 227-228
 - rerun, 404
 - sounding beep, 401
 - turning logging on or off, 225-226
 - which include Terminal Interface commands, 406-407
- command line options, 57-58, 65
 - for connection and transport, 318

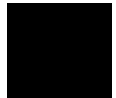

- command summary, 204
- comments in command files, 405
- communications (emulator), setting up, 318-320
- CONFIG.SYS file, 491-493
- configuration
 - emulator, 302-310
 - inconsistencies, checking for, 95
 - saving and loading, 100-101
- configuring
 - chip selects, 76
 - emulator for in-circuit operation, 108-126
 - function-code lines, 77
 - read/write lines, 78
 - strobe lines, 79
 - write-enable lines, 80
- connecting the emulator probe, 107
- connection problems
 - LAN, 481
 - RS-232, 478
 - RS-422, 483
- connection, command line option, 318
- Continuous Update (ALT, -, U) command, 346
- control menu, 497-501
- Copy→Destination... (ALT, -, P, D) command, 342
- Copy→Registers (ALT, -, P, R) command, 362
- Copy→Window (ALT, -, P, W) command, 341
- Could not open initialization file, 411
- Could not write Memory, 412
- count conditions, 285-287, 497-501
- count information
 - displaying absolute, 183, 385
 - displaying relative, 183, 385
- crystal, selecting, 70
- CTRL key and double-clicks, 55
- current PC in Source window, 371
- cursor, locating cursor from command file, 370
- cursor-select, 33
- cut and paste, 55
- cycles, driving monitor to target system, 81

- D**
- data bus width, selecting, 71
- data strobe, buffering, 79
- DCE or DTE selection and RS-232 cable, 473
- debugger
 - arranging icons in window, 332
 - cascaded windows, 332
 - exiting, 50, 58, 234
 - exiting locked, 235
 - installing software, 475-477
 - opening windows, 333-334
 - overview, 4
 - starting, 25, 57, 478-483
 - startup options, 58
 - tiled windows, 332
 - windows, opening, 60
- decimal values, how to enter, 211
- deleting all breakpoints, 156
- demo board bus width, selecting, 71
- demo programs, 24
 - loading, 31
 - mapping memory, 29-30
 - running, 34
- DeMorgan's law, 285-287
- device register
 - dialog boxes, 437
 - window, 436
- Device Regs window, continuous update, 346
- dialog box, breakpoints, 256-257
- dialog boxes, file selection, 236
- directories
 - search path, 372
 - source, 336
- display fonts, changing, 26
- display mode
 - mixed, 130
 - source only, 130
 - toggling, 365-366, 383
- Display→Select Source... (ALT, -, D, L) command, 366
- DLL errors, 482
- DMA cycles, tracing, 83
- do while statements (C), single-stepping, 453

- don't care values, how to enter, 211
- double-clicks and the CTRL key, 55
- DTACK
 - driving high to deassert, 82
 - interlock, 74
 - pullup resistor, 121
 - signals, 117
 - target, enabling or disabling on emulation memory accesses, 85
- dynamic variables, 258-259, 389, 452
- E**
 - edit breakpoints, 256-257
 - embedded microprocessor system, 497-501
 - EMIPLCR value is not consistent with VCCSYN/MODCLK, 413-414
 - EMSIM registers
 - copying to 6830x SIM registe, 94
 - differences between SIM registers and, 93
 - emulator, 91
 - loading with 6830x SIM regis, 93
 - resetting to processor defaults, 94
 - using the, 91-94
 - emulation memory, 497-501
 - accesses, enabling or disabling target DTACK, 85
 - copying target system memory into, 164, 357
 - emulation microprocessor, resetting, 148, 249
 - emulation monitor, 497-501
 - emulator, 497-501
 - clock source, selecting, 70
 - hardware options, setting, 69-87
 - probe, plugging-in, 107
 - status, HALTED, 118
 - emulator configuration, 68, 302-310
 - loading, 101, 231
 - saving, 100, 232
 - verifying, 95-98
 - enable condition, 497-501
 - enable store condition, 497-501
 - environment variables, 132
 - HP64700 , 491-493
 - HPTABLES, 491-493
 - PATH, 491-493

environment
 loading, 229
 saving, 230

error messages, 410
 Bad RS-232 port name, 411
 Bad RS-422 card I/O address, 411
 Could not open initialization file, 411
 Could not write Memory, 412
 EMIPLCR value is not consistent with VCCSYN/MODCLK, 413-414
 Error occurred while processing Object file, 415
 general RS-232 communications error, 416
 general RS-422 communications error, 416
 HP 64700 locked by another user, 417
 HP 64700 not responding, 417
 Incorrect DLL version, 417
 Incorrect LAN Address (HP-ARPA, Windows for Workgroups), 418
 Incorrect LAN Address (Novell), 419
 Incorrect LAN Address (WINSOCK), 419
 Internal error in communications driver, 420
 Internal error in Windows, 420
 Interrupt execution (during run to caller), 420
 Interrupt execution (during step over), 421
 Interrupt execution (during step), 421
 Invalid transport name, 422
 LAN buffer pool exhausted, 422
 LAN communications error, 423
 LAN MAXSENDSIZE is too small, 423
 LAN socket error, 423
 Object file format ERROR, 424
 Out of DOS Memory for LAN buffer, 425
 Out of DOS Windows timer resources, 426
 PC is out of RAM memory, 426
 Timed out during communications, 427

ethernet address, 468

Evaluate It command, 396

Execution→Break (F4), (ALT, E, B) command, 248

Execution→Reset (ALT, E, E) command, 249

Execution→Run (F5), (ALT, E, U) command, 237

Execution→Run to Caller (ALT, E, T) command, 239

Execution→Run to Cursor (ALT, E, C) command, 238

Execution→Run... (ALT, E, R) command, 240-241

- Execution→Single Step (F2), (ALT, E, N) command, 242
- Execution→Step Over (F3), (ALT, E, O) command, 243
- Execution→Step... (ALT, E, S) command, 244-247
- exiting command file execution, 402
- Expression window, 438
 - clearing, 347
 - displaying expressions, 348
- expressions, 210
 - displaying, 348
- externals, displaying symbol information, 137, 374
- F**
 - file selection dialog boxes, 236
 - File→Command Log→Log File Name... (ALT, F, C, N) command, 224
 - File→Command Log→Logging OFF (ALT, F, C, F) command, 226
 - File→Command Log→Logging ON (ALT, F, C, O) command, 225
 - File→Copy Destination... (ALT, F, P) command, 233
 - File→Exit (ALT, F, X) command, 234
 - File→Exit HW Locked (ALT, F, H) command, 235
 - File→Load Debug... (ALT, F, D) command, 229
 - File→Load Emulator Config... (ALT, F, E) command, 231
 - File→Load Object... (ALT, F, L) command, 221-223
 - File→Run Cmd File... (ALT, F, R) command, 227-228
 - File→Save Debug... (ALT, F, S) command, 230
 - File→Save Emulator Config... (ALT, F, V) command, 232
 - firmware
 - ensuring performance after update, 496
 - using PROGFLASH to update, 494-495
 - version information, 335
 - firmware update
 - connecting the HP 64700 to the PC, 489-490
 - utility, installing, 491-493
 - fonts
 - changing, 62
 - settings, 324-325
 - sizing, 26
 - for statements (C), single-stepping, 453
 - foreground memory, 497-501
 - foreground monitor program, 497-501
 - foreground operation, tracing, 328-329
 - function arguments, 434, 455-456
 - function codes, 88, 215

- function keys, 56
- function-code lines, buffering, 77
- functions
 - displaying symbol information, 136, 374
 - running until return, 41, 146, 239
 - searching, 133, 369
 - stepping over, 42, 144, 243
 - tracing callers, 47-48, 175, 262-263
 - tracing execution within, 177, 264-265
 - tracing flow, 46, 174, 261
- G**
 - gateway, 481
 - gateway address, 468
 - general RS-232 communications error, 416
 - general RS-422 communications error, 416
 - global assembler symbols, displaying, 139, 376
 - global symbols, displaying, 137, 374
 - global variables, 137, 178-179, 374
 - glossary, 497-501
 - guarded memory, 88, 311-313, 446, 497-501
- H**
 - HALTED emulator status, 118
 - hardware
 - locking on exit, 235
 - options, setting, 69-87
 - requirements, 463
 - help for error messages, 410
 - Help→About Debugger/Emulator... (ALT, H, D) command, 335
 - hexadecimal values, how to enter, 211
 - high DTACK, driving, 82
 - hostname, 318-320
 - HP 64037 card, I/O address, 318
 - HP 64700 firmware
 - ensuring performance after update, 496
 - installing update utility, 491-493
 - update, connecting the HP 64700 to the PC, 489-490
 - using PROGFLASH to update, 494-495
 - HP 64700 LAN port number, 481
 - HP 64700 locked by another user, 417
 - HP 64700 not responding, 417

- HP 64700
 - connecting to the PC, 465-474
 - connecting via LAN, 468
 - connecting via RS-232, 465
 - connecting via RS-422, 472
- HP 64700 switch settings
 - LAN, 481
 - RS-232, 478
 - RS-422, 483
- HP-ARPA LAN transport DLL, 482
- HP64700 environment variable, 491-493
- HPTABLES environment variable, 491-493

I

- I/O locations
 - displaying, 167
 - editing, 168
 - guarding, 295-296
 - specifying, 349
- I/O window, 439
 - turning polling ON or OFF, 104
- IACK7 strobe, buffering, 79
- IACK7/PB0 pin operation, selecting, 86
- icon, for a different emulator, 58
- icons (debugger window), arranging, 332
- IEEE-695 object files, 453
- in-circuit emulation problems, 123
- in-circuit operation
 - configuring the emulator for, 108-126
 - important concepts, 108
- in-line assembler, 301
- inconsistencies, checking configuration for, 95
- Incorrect DLL version, 417
- Incorrect LAN Address (HP-ARPA, Windows for Workgroups), 418
- Incorrect LAN Address (Novell), 419
- Incorrect LAN Address (WINSOCK), 419
- .INI file, 318
- initial values for PC/SSP, specifying, 84
- installation path, 475-477
- Internal error in communications driver, 420
- Internal error in Windows, 420
- internals, displaying symbol information, 138, 375
- Internet Address, 318-320, 468, 474

interrupt 7 operation, specifying, 87
Interrupt execution

- during run to caller, 420
- during step over, 421
- during step, 421

interrupt modes, 115
interrupts (target system), enabling or disabling, 83
interset operators, 285-287
intraset operators, 285-287
intrusion, monitor, 103, 293-294
Invalid transport name, 422
I/O address for HP 64037 card, 318
IP address, 318, 481

L labels, 212-214, 301
LAN buffer pool exhausted, 422
LAN cards, 463-464
LAN communication, 318-320, 478-483
LAN communications error, 423
LAN connection problems, 481
LAN MAXSENDSIZE is too small, 423
LAN socket error, 423
LAN, connecting HP 64700, 468
levels, trace sequence, 193, 197, 278-281, 292
limitations, Symbol window, 449
line (source file), running until, 43, 146, 238
line numbers missing in Source window, 63
link level address, 468
list file

- changing the destination, 61
- copying window contents to, 61

listing files, specifying, 233, 342
loading file error, 412
local assembler symbols, displaying, 139, 376
local symbols, displaying, 138, 375
local variables, 138-139, 375
lock hardware on exit, 235
log (command) files, 64, 224-228
logical operators, 188, 193, 285-287

- M** macro, 497-501
- MCC68K, compiling programs with, 455
- Memory window, 440
 - displaying 16-bit values, 352
 - displaying 32-bit values, 352
 - displaying bytes, 352
 - displaying multicolumn format, 352
 - displaying single-column format, 351
 - turning polling ON or OFF, 104
- memory
 - abort during load, 330
 - copying, 163, 355
 - displaying, 160
 - editing, 162
 - loading from stored file, 359
 - map, displaying information, 97
 - mapping, 88-90, 311-313
 - mapping for demo program, 29-30
 - modifying a range, 165, 356
 - searching for a value or string in, 166
 - storing to a binary file, 360
 - target system, copying into emulation memory, 164, 357
 - type, 88, 311-313
- messages, error, 410
- microprocessor, resetting, 148, 249
- mixed display mode, 130, 365, 383, 453
- monitor, 497-501
 - cycles, driving to target system, 81
 - intrusion, 103, 148, 249, 293-294, 450
- N** nesting command files, 403
- network name, 318
- no-operation command, 405
- noabort, during object file or memory load, 330
- Novell LAN transport DLL, 482
- numeric constants, 211

- O**
 - Object file format ERROR, 424
 - object files, 497-501
 - abort during load, 330
 - IEEE-695, 453
 - loading, 129, 221-223
 - operators
 - C, 215
 - interset, 285-287
 - intraset, 285-287
 - logical, 188, 193, 285-287
 - optimization option, compiler, 455
 - options, command line, 58
 - oscillator, selecting, 70
 - Out of DOS Memory for LAN buffer, 425
 - Out of Windows timer resources, 426
 - overlapping address ranges, 497-501
 - overview, 4

- P**
 - parameters, command file, 227-228
 - paste, cut and, 55
 - PATH environment variable, 491-493
 - path for source file search, 132, 372
 - paths for source files, prompting, 331
 - patterns, trace, 188, 193, 274-281, 285-289
 - PC is out of RAM memory, 426
 - PC
 - connecting HP 64700, 465-474
 - locating in Source window, 371
 - PC/SSP specifying initial values for, 84
 - performance (PC), optimizing for the debugger, 485
 - performance verification after firmware update, 496
 - ping command, 481
 - platform requirements, 463
 - plug-in problems, 123
 - pointers (C operators), 215
 - polling for debugger windows, turning ON or OFF, 104
 - pop-up menus, 497-501
 - accessing, 394
 - port name, RS-232, 318
 - port
 - BNC, 99, 285-287, 321-323
 - communication, 318-320



- pragma statements (C), source file information, 453
- prestore condition, 188, 193, 274-281, 450, 497-501
- primary branch condition, 193, 278-281, 497-501
- probe, plugging in, 107
- processor, resetting, 148, 249
- PROGFLASH firmware update utility, 494-495
- program counter, 143, 147, 237, 240-241, 244-247, 441, 443
 - setting the reset value, 27-28
- program modules, displaying symbol information, 136, 373
- programs
 - compiling with AxLS, 456
 - compiling with MCC68K, 455
 - demo, 24
 - loading, 129, 221-223
 - running, 147, 237, 240-241
 - stopping execution, 147
- Q**
 - qualifier, state, 185, 271-273
 - quick start information, 23
- R**
 - read/write lines, buffering, 78
 - real-time mode
 - disabling, 103, 294
 - enabling, 103, 293
 - options, setting, 102-104
 - RealTime→I/O Polling→OFF (ALT, R, I, F) command, 296
 - RealTime→I/O Polling→ON (ALT, R, I, O) command, 295
 - RealTime→Memory Polling→OFF (ALT, R, M, F) command, 300
 - RealTime→Memory Polling→ON (ALT, R, M, O) command, 299
 - RealTime→Monitor Intrusion→Allowed (ALT, R, T, A) command, 294
 - RealTime→Monitor Intrusion→Disallowed (ALT, R, T, D) command, 293
 - RealTime→Watchpoint Polling→OFF (ALT, R, W, F) command, 298
 - RealTime→Watchpoint Polling→ON (ALT, R, W, O) command, 297
 - register variables, 455-456
 - Register window, 441
 - copying information from, 362
 - registers
 - displaying, 44-45, 169
 - editing, 171
 - relative count information, displaying, 183, 385
 - requirements, hardware, 463

requirements, platform, 463
 rerun command files, 404
 reset
 emulator, 148, 249
 emulator status, 446
 mode configuration, displaying information, 98
 running from target system, 147, 240-241
 value for supervisor stack pointer and program counter, 27-28
 restart condition, 188, 274-277, 497-501
 restriction on number of RS-232 connections, 478
 return (function), running until, 41, 146, 239
 ROM
 enabling or disabling breaks on writes to, 73
 writes occurring, 73
 RS-232
 cable and DCE or DTE selection, 473
 connection problems, 478
 connections restriction, 478
 connecting HP 64700, 465
 RS-422
 connection problems, 483
 connecting HP 64700, 472
 RTC Emulation Connection dialog box, 318
 Run to Cursor command, 397

S

screen fonts, changing, 26
 search path, 482
 for source files, 132, 372
 Search→Address... (ALT, -, R, A) command, 370
 Search→Current PC (ALT, -, R, C) command, 371
 Search→Function... (ALT, -, R, F) command, 369
 Search→String... (ALT, -, R, S) command, 367
 Search... (ALT, -, R) command, 353
 secondary branch condition, 193, 278-281, 497-501
 sequence levels, 292, 497-501
 service ports, TCP, 468
 Set Breakpoint command, 396
 Settings→BNC→Input to Analyzer Arm (ALT, S, B, I) command, 323
 Settings→BNC→Outputs Analyzer Trigger (ALT, S, B, O) command, 321-322
 Settings→Communication... (ALT, S, C) command, 318-320
 Settings→Emulator Config→Hardware... (ALT, S, E, H) command, 302-310

Settings→Emulator Config→Information... (ALT, S, E, I) command, 314-317
 Settings→Emulator Config→Memory Map... (ALT, S, E, M) command, 311-313
 Settings→Extended→Load Error Abort→OFF (ALT, S, X, L, F) command, 330
 Settings→Extended→Load Error Abort→ON (ALT, S, X, L, O) command, 330
 Settings→Extended→Source Path Query→OFF (ALT, S, X, S, F) command, 331
 Settings→Extended→Source Path Query→ON (ALT, S, X, S, O) command, 331
 Settings→Extended→Trace Cycles→Both (ALT, S, X, T, B) command, 329
 Settings→Extended→Trace Cycles→Monitor (ALT, S, X, T, M) command, 328
 Settings→Extended→Trace Cycles→User (ALT, S, X, T, U) command, 328
 Settings→Font... (ALT, S, F) command, 324-325
 Settings→Symbols→Case Sensitive→OFF (ALT, S, S, C, F) command, 327
 Settings→Symbols→Case Sensitive→ON (ALT, S, S, C, O) command, 327
 Settings→Tabstops... (ALT, S, T) command, 326
 SIM registers
 copying to EMSIM registers, 93
 differences between EMSIM registers and, 93
 loading with EMSIM register values, 94
 SIM, displaying assembly code for setting up the, 98
 single-step one line, 36
 software breakpoints, specifying TRAP number, 72
 software, installing debugger, 475-477
 Source at Stack Level command, 395
 source directory, 336
 source display mode, toggling, 365-366
 source file line, running until, 43, 146, 238
 source files
 displaying, 32, 131, 366
 displaying from BackTrace window, 395
 information generated for pragma statements, 453
 prompting for paths, 331
 searching for addresses, 133, 370
 searching for function names, 133, 369
 searching for strings, 134, 367
 specifying search directories, 132

- source lines
 - stepping multiple, 145, 244-247
 - stepping single, 143, 242
- source only
 - displaying, 130, 384
 - displaying in Memory window, 365-366
- Source window, 443
 - line numbers missing, 63
 - locating current PC, 371
 - setting colors, 63
 - setting tabstops, 62
 - toggling the display mode, 365-366
- SRCPATH environment variable, 132
- SSP/PC, specifying initial values for, 84
- startup options, 58
- state qualifier, 185, 271-273, 497-501
- status register, editing, 363
- status values, 458, 497-501
- Status window, 446
- step multiple lines, 37
- step one line, 36
- store, 185
- store conditions, 285-287, 497-501
- strings
 - displaying symbols containing, 142, 379
 - searching memory for, 166, 353
 - searching source files, 134, 367
- strobe lines, buffering, 79
- structures (C operators), 215
- subnet mask, 468, 481
- subroutines, stepping over, 243
- supervisor stack pointer, setting the reset value, 27-28
- Symbol window, 449
 - copying information, 378-379
 - searching for strings, 379
- symbols, 212-214
- system setup, 464



- T**
- tabstop settings, 326
- tabstops in the Source window, setting, 62
- target BERR signal, enabling or disabling, 74
- target DTACK, enabling or disabling on emulation memory accesses, 85
- target memory access size, 120
 - selecting, 71
- target system, 497-501
 - interrupts, enabling or disabling, 83
 - memory, copying into emulation memory, 164, 357
- TCP service ports, 468
- telnet, 468, 474
- TERMCOM command, 406-407
- Terminal Interface commands, 406-407
- text, selecting, 55
- Timed out during communications, 427
- TimeoutSeconds, 427
- trace
 - display mode, toggling, 383
 - foreground/background operation, 328-329
 - patterns, 188, 193, 274-281, 285-289
 - range, 290-291
 - setting up a sequence, 193
 - settings, 285-287
 - signals, 458
- trace specification
 - copying, 388
 - editing, 197, 270
 - loading, 200
 - specifying the destination, 388
 - storing, 199
- trace state, 497-501
 - searching for in Trace Window, 387
- Trace window, 450
 - copying information, 386
 - displaying absolute count information, 385
 - displaying bus cycles only, 384
 - displaying relative count information, 385
 - displaying source only, 384
 - toggling the display mode, 383
- Trace→Again (F7), (ALT, T, A) command, 284
- Trace→Edit... (ALT, T, E) command, 270

- Trace→Find Then Trigger... (ALT, T, D) command, 274-277
 - Trace→Function Caller... (ALT, T, C) command, 262-263
 - Trace→Function Flow (ALT, T, F) command, 261
 - Trace→Function Statement... (ALT, T, S) command, 264-265
 - Trace→Halt (ALT, T, H) command, 283
 - Trace→Sequence... (ALT, T, Q) command, 278-281
 - Trace→Trigger Store... (ALT, T, T) command, 271-273
 - Trace→Until Halt (ALT, T, U) command, 282
 - Trace→Variable Access... (ALT, T, V) command, 266-267
 - Trace→Variable Break... (ALT, T, B) command, 268-269
 - tracing of DMA cycles, 83
 - transfer address, 34, 145, 147, 240-241, 244-247, 497-501
 - transport selection, 318
 - transport, command line option, 318
 - TRAP number for breakpoints, specifying, 72
 - trigger, 185, 497-501
 - condition, 185, 497-501
 - position, 185, 497-501
 - state, searching for in Trace window, 387
 - store condition, 185, 497-501
 - tutorial, 24
 - type of memory, 88, 311-313
- U**
- unary minus operator, 215
 - unions (C operators), 215
 - unlock emulator, 318
 - user ID, 318, 475-477
 - user name, 318
 - user programs, loading, 129
 - user-defined symbols
 - creating, 140, 380
 - deleting, 142, 381-382
 - displaying, 141, 378
 - Utilities→Copy... (ALT, -, U, C) command, 355
 - Utilities→Fill... (ALT, -, U, F) command, 356
 - Utilities→Image... (ALT, -, U, I) command, 357
 - Utilities→Load... (ALT, -, U, L) command, 359
 - Utilities→Store... (ALT, -, U, S) command, 360
- V**
- values, searching memory for, 166, 353
 - Variable→Edit... (ALT, V, E) command, 258-259

- variables
 - auto, 157-159
 - displaying, 38, 157
 - dynamic, 258-259, 389, 452
 - editing, 39, 158, 258-260
 - environment, 132
 - global, 137, 178-179, 374
 - local, 138-139, 375
 - monitoring in the WatchPoint window, 40, 159
 - register, 455-456
 - tracing a particular value and breaking, 179, 268-269
 - tracing accesses, 49, 178, 266-267
 - verification of emulator performance, 496
 - verifying the emulator configuration, 95-98
 - version information, 335, 484
- W**
- WAIT command, 208, 337
 - wait delays, inserting in command files, 408
 - watchdog timer, keeping alive, 81
 - watchpoint, 497-501
 - WatchPoint window, 452
 - monitoring variables in, 40, 159
 - turning polling ON or OFF, 104
 - watchpoints, editing, 389
 - while statements (C), single-stepping, 453
 - width of data bus, 71
 - window contents, copying to the list file, 61
 - Window→1-9 (ALT, W, 1-9) command, 333
 - Window→Arrange Icons (ALT, W, A) command, 332
 - Window→Cascade (ALT, W, C) command, 332
 - Window→More Windows... (ALT, W, M) command, 334
 - Window→Tile (ALT, W, T) command, 332
 - windows (debugger), opening, 333-334
 - Windows for Workgroups LAN transport DLL, 482
 - windows of program execution, tracing, 197
 - WINSOCK LAN transport DLL, 482
 - WINSOCK.DLL, 482
 - WLIBSOCK.DLL, 482
 - write-enable lines, buffering, 80
 - writes to ROM, enabling or disabling breaks on, 73
 - WSOCKETS.DLL, 482

Certification and Warranty

Certification

Hewlett-Packard Company certifies that this product met its published specifications at the time of shipment from the factory. Hewlett-Packard further certifies that its calibration measurements are traceable to the United States National Bureau of Standards, to the extent allowed by the Bureau's calibration facility, and to the calibration facilities of other International Standards Organization members.

Warranty

This Hewlett-Packard system product is warranted against defects in materials and workmanship for a period of 90 days from date of installation. During the warranty period, HP will, at its option, either repair or replace products which prove to be defective.

Warranty service of this product will be performed at Buyer's facility at no charge within HP service travel areas. Outside HP service travel areas, warranty service will be performed at Buyer's facility only upon HP's prior agreement and Buyer shall pay HP's round trip travel expenses. In all other cases, products must be returned to a service facility designated by HP.

For products returned to HP for warranty service, Buyer shall prepay shipping charges to HP and HP shall pay shipping charges to return the product to Buyer. However, Buyer shall pay all shipping charges, duties, and taxes for products returned to HP from another country. HP warrants that its software and firmware designated by HP for use with an instrument will execute its programming instructions when properly installed on that instrument. HP does not warrant that the operation of the instrument, or software, or firmware will be uninterrupted or error free.

Limitation of Warranty

The foregoing warranty shall not apply to defects resulting from improper or inadequate maintenance by Buyer, Buyer-supplied software or interfacing, unauthorized modification or misuse, operation outside of the environment specifications for the product, or improper site preparation or maintenance.

No other warranty is expressed or implied. HP specifically disclaims the implied warranties of merchantability and fitness for a particular purpose.

Exclusive Remedies

The remedies provided herein are buyer's sole and exclusive remedies. HP shall not be liable for any direct, indirect, special, incidental, or consequential damages, whether based on contract, tort, or any other legal theory.

Product maintenance agreements and other customer assistance agreements are available for Hewlett-Packard products.

For any assistance, contact your nearest Hewlett-Packard Sales and Service Office.

Safety

Summary of Safe Procedures

The following general safety precautions must be observed during all phases of operation, service, and repair of this instrument. Failure to comply with these precautions or with specific warnings elsewhere in this manual violates safety standards of design, manufacture, and intended use of the instrument. Hewlett-Packard Company assumes no liability for the customer's failure to comply with these requirements.

Ground The Instrument

To minimize shock hazard, the instrument chassis and cabinet must be connected to an electrical ground. The instrument is equipped with a three-conductor ac power cable. The power cable must either be plugged into an approved three-contact electrical outlet or used with a three-contact to two-contact adapter with the grounding wire (green) firmly connected to an electrical ground (safety ground) at the power outlet. The power jack and mating plug of the power cable meet International Electrotechnical Commission (IEC) safety standards.

Do Not Operate In An Explosive Atmosphere

Do not operate the instrument in the presence of flammable gases or fumes. Operation of any electrical instrument in such an environment constitutes a definite safety hazard.

Keep Away From Live Circuits

Operating personnel must not remove instrument covers. Component replacement and internal adjustments must be made by qualified maintenance personnel. Do not replace components with the power cable connected. Under certain conditions, dangerous voltages may exist even with the power cable removed. To avoid injuries, always disconnect power and discharge circuits before touching them.

Do Not Service Or Adjust Alone

Do not attempt internal service or adjustment unless another person, capable of rendering first aid and resuscitation, is present.

Do Not Substitute Parts Or Modify Instrument

Because of the danger of introducing additional hazards, do not install substitute parts or perform any unauthorized modification of the instrument. Return the instrument to a Hewlett-Packard Sales and Service Office for service and repair to ensure that safety features are maintained.

Dangerous Procedure Warnings

Warnings, such as the example below, precede potentially dangerous procedures throughout this manual. Instructions contained in the warnings must be followed.

WARNING

Dangerous voltages, capable of causing death, are present in this instrument. Use extreme caution when handling, testing, and adjusting.

Safety Symbols Used In Manuals

The following is a list of general definitions of safety symbols used on equipment or in manuals:



Instruction manual symbol: the product is marked with this symbol when it is necessary for the user to refer to the instruction manual in order to protect against damage to the instrument.



Indicates dangerous voltage (terminals fed from the interior by voltage exceeding 1000 volts must be marked with this symbol).



OR



Protective conductor terminal. For protection against electrical shock in case of a fault. Used with field wiring terminals to indicate the terminal which must be connected to ground before operating the equipment.



Low-noise or noiseless, clean ground (earth) terminal. Used for a signal common, as well as providing protection against electrical shock in case of a fault. A terminal marked with this symbol must be connected to ground in the manner described in the installation (operating) manual before operating the equipment.



OR



Frame or chassis terminal. A connection to the frame (chassis) of the equipment which normally includes all exposed metal structures.



Alternating current (power line).



Direct current (power line).



Alternating or direct current (power line).

Caution

The Caution sign denotes a hazard. It calls your attention to an operating procedure, practice, condition, or similar situation, which, if not correctly performed or adhered to, could result in damage to or destruction of part or all of the product.

Warning

The Warning sign denotes a hazard. It calls your attention to a procedure, practice, condition or the like, which, if not correctly performed, could result in injury or death to personnel.